

FPSAC PROCEEDINGS 2004  
ACTES SFCA 2004  
Vancouver CANADA



16th Annual International Conference on  
FORMAL POWER SERIES AND ALGEBRAIC COMBINATORICS  
June 28 - July 2, 2004  
University of British Columbia  
(Vancouver B.C., Canada)

16ième Conférence Internationale sur  
SÉRIES FORMELLES ET COMBINATOIRE ALGÈBRIQUE  
28 juin - 2 juillet 2004  
University of British Columbia  
(Vancouver C.B., Canada)



Programme Committee – Comité de programme

Jonathan Borwein (*Simon Fraser, Dalhousie*), chair/président  
Mike Atkinson (*Otago*)  
Nantel Bergeron (*CRC, York*)  
Luisa Carini (*Messina*)  
William Chen (*Nankai*)  
Sylvie Corteel (*CNRS U.V.S.Q.*)  
Ira Gessel (*Brandeis*)  
Ian Goulden (*Waterloo*)  
Michael Joswig (*T.U. Berlin*)  
Martin Klazar (*Prague*)  
Christian Krattenthaler (*Lyon*)  
Gilbert Labelle (*UQAM*)  
Soichi Okada (*Nagoya*)  
Margaret Readdy (*Kentucky*)  
Frank Sottile (*Massachusetts*)  
Einar Steingrímsson (*Göteborg*)  
Julian West (*Malaspina, Victoria*), co-chair/co-président  
Stephanie van Willigenburg (*UBC*), co-chair/co-président

Organizing Committee – Comité d'organisation

Julian West (*Malaspina, Victoria*), chair/président  
Nantel Bergeron (*CRC at York*)  
Luis Goddyn (*Simon Fraser*)  
Marni Mishna (*Bordeaux*)  
Tom Roby (*Cal State Hayward*)  
Frank Ruskey (*Victoria*)  
Stephanie van Willigenburg (*UBC*)

Sponsors – Commanditaires





## FORWARD

In a manner which I suppose will be familiar to anybody who has organized a mathematical conference, FPSAC 2004 in Vancouver took gradual shape over the course of many previous conferences.

The idea of holding a FPSAC in British Columbia was first raised at the 2001 FPSAC in Arizona, when Daniel Krob, then chair of the FPSAC permanent committee gave an informal endorsement to the project. Some names were mentioned at a refreshment break in the lobby; more than one of these eventually did become an invited speaker at FPSAC 2004.

It was at the banquet of the Summer meetings of the Canadian Mathematical Society at Laval University, Quebec that Pierre Leroux and I sat down with Jon Borwein, and Jon agreed to be the chair of our scientific committee. At that moment I realized the conference would be a success. Formal arrangements were made later that summer at the FPSAC meeting in Melbourne, Australia.

In Linkoping, Sweden, last summer, the torch was passed to us, and our conference formally announced.

Finally, at the CMS winter meetings in Vancouver last December, Jon Borwein and I met with Klaus Peters and began the discussions which led to the volume now in your hands.

At all of these gatherings, I received invaluable advice and encouragement from many colleagues. Nantel Bergeron was a vital voice of experience and our link to the FPSAC permanent committee, and Christian Krattenthaler helped advise on many decisions both mathematical and otherwise. I can thank without listing all of the combinatorists who served on both the scientific and organizing committees, though I should make special mention of Stephanie van Willigenburg, without whose presence at UBC many aspects of the conference would not have been possible; Marni Mishna, who is responsible for the excellent quality of both the electronic and the print proceedings; and Tom Roby, who put in far more than his share of work and was the principal investigator on the conference's NSA and NSF grants.

Finally, I wish to thank all the contributors to the volume, and all the participants, who are the life-blood of any conference.

Julian West  
Malaspina/ University of Victoria



## TABLE OF CONTENTS

PART 1. Invited Speakers – Conférenciers Invités	3
CHROMATIC POLYNOMIALS AND THE SYMMETRIC GROUP. Norman Biggs .....	5
DECOMPOSABLE COMPOSITIONS AND RIBBON SCHUR FUNCTIONS. Louis J. Billera .....	7
INTERSECTING SCHUBERT VARIETIES. Sara Billey .....	9
ALEXANDER DUALITY IN COMBINATORICS. Takayuki Hibi .....	11
SUMS OF POLYNOMIALS FROM DEGENERATION IN ALGEBRAIC GEOMETRY. Allen Knutson .....	13
OPERADS AND COMBINATORICS. J.-L. Loday .....	15
ASYMPTOTICS OF MULTIVARIATE GENERATING FUNCTIONS. Robin Pemantle .....	17
VIRTUAL CRYSTALS. Anne Schilling .....	19
THE PHASE TRANSITION FOR RANDOM SUBGRAPHS OF THE $n$ -CUBE. Gordon Slade .....	23
PART 2. Presentations – Présentations	27
SYSTEMS GENERATED BY ZEILBERGER'S ALGORITHM. S. A. Abramov and H. Q. Le .....	29
GROWTH OF MEANDER NUMBERS. M. H. Albert and M. S. Paterson .....	39
THE BERGMAN COMPLEX OF A MATROID AND PHYLOGENETIC TREES. Federico Ardila and Caroline J. Klivans .....	49
SCHUR-POSITIVITY. François Bergeron, Riccardo Biagioli, and Mercedes Rosas .....	59
A FOUR-PARAMETER PARTITION IDENTITY. Cilanne E. Boulet .....	69
FINITE AUTOMATA AND PATTERN AVOIDANCE. Petter Brändén and Toufik Mansour .....	73

HEIGHT ARROW MODEL. A. Dartois and D. Rossin .....	87
JUMPING PARTICLES. E. Duchi and G. Schaeffer .....	103
SCHUR P-FUNCTIONS AND WEYL'S DENOMINATOR FORMULA. A. M. Hamel and R. C. King .....	121
THE OCTAHEDRON RECURRENCE AND $\mathfrak{gl}_n$ CRYSTALS. A. Henriques and J. Kamnitzer .....	133
SIGNED BIRKHOFF TRANSFORM. Samuel K. Hsiao .....	147
RIBBON TABLEAUX. Thomas Lam .....	159
$q, t$ -KOSTKA POLYNOMIALS AND THE AFFINE SYMMETRIC GROUP. L. Lapointe and J. Morse .....	173
AFFINE WEYL GROUPS AND REPRESENTATION THEORY. Cristian Lenart and Alexander Postnikov .....	187
AFFINE LIE ALGEBRAS. Peter Magyar .....	199
TUTTE MEETS POINCARÉ. Jeremy L. Martin .....	207
A HOPF ALGEBRA OF PARKING FUNCTIONS. J.-C. Novelli and J.-Y. Thibon .....	215
AN ARCTIC CIRCLE THEOREM FOR GROVES. T. K. Petersen and D. Speyer .....	227
THE EQUIVARIANT ORLIK-SOLOMON ALGEBRA. Nicholas Proudfoot .....	239
A POLYNOMIALITY PROPERTY FOR LITTLEWOOD-RICHARDSON COEFFICIENTS. E. Rassart .....	249
CAMBRIAN LATTICES. Nathan Reading .....	263
TNN $f$ -IMMANANTS. B. Rhoades and M. Skandera .....	271
WEAK AND $KL$ ORDERS ON TABLEAUX. Victor Reiner and Muge Taskin .....	281



DEFORMED UNIVERSAL CHARACTERS.	
Mark Shimozono and Mike Zabrocki .....	291
TAMARI LATTICES AND NON-CROSSING PARTITIONS IN TYPES $B$ AND $D$ .	
Hugh Thomas .....	303
ENUMERATION OF TOTALLY POSITIVE GRASSMANN CELLS.	
Lauren K. Williams .....	313



PART 1

Invited Speakers  
Conférenciers Invités





## Chromatic Polynomials and Representations of the Symmetric Group

Norman Biggs

The chromatic polynomial  $P(G; k)$  is the function which gives the number of ways of colouring a graph  $G$  when  $k$  colours are available. The fact that it is a polynomial function of  $k$  is essentially a consequence of the fact that, when  $k$  exceeds the number of vertices of  $G$ , not all the colours can be used. Another quite trivial property of the construction is that the names of the  $k$  colours are immaterial; in other words, if we are given a colouring, then any permutation of the colours produces another colouring. In this talk I shall outline some theoretical developments, based on these simple facts and some experimental observations about the complex roots of chromatic polynomials of ‘bracelets’.

A ‘bracelet’  $G_n = G_n(B, L)$  is formed by taking  $n$  copies of a graph  $B$  and joining each copy to the next by a set of links  $L$  (with  $n + 1 = 1$  by convention). The chromatic polynomial of  $G_n$  can be expressed in the form

$$P(G_n; k) = \sum_{\pi} m_{B, \pi}(k) \operatorname{tr}(N_L^{\pi})^n.$$

The sum is taken over all partitions  $\pi$  such that  $0 \leq |\pi| \leq b$ , where  $b$  is the number of vertices of  $B$ . The terms  $m_{B, \pi}(k)$  are polynomials in  $k$ , and they are independent of  $L$ . When  $B$  is the complete graph  $K_b$  the relevant polynomials  $m_{\pi}(k)$  are given by a remarkably simple formula, and when  $B$  is incomplete they can be expressed in terms of the  $m_{\pi}(k)$  with  $|\pi| \leq b$ . The entries of the matrices  $N_L^{\pi}$  are also polynomials in  $k$ , but they do depend on  $L$ . In order to calculate these entries we construct explicit bases for certain irreducible modules, corresponding to the Specht modules of representation theory.

### References

- (1) N.L. Biggs: Equimodular curves, *Discrete Math.* 259 (2002) 37-57.
- (2) N.L. Biggs, M.H. Klin, P. Reinfeld, Algebraic methods for chromatic polynomials, *European J. Combinatorics* 25 (2004) 147-160.
- (3) N.L. Biggs, Specht modules and chromatic polynomials, *CDAM Research Report Series* LSE-CDAM-2003-06.





## Decomposable Compositions and Ribbon Schur Functions

Louis J. Billera

**Abstract.** *We describe recent results, obtained in collaboration with Hugh Thomas and Stephanie van Willigenburg [1], which provide a complete description of when two ribbon Schur functions are identical.*

**Résumé.** *Nous présentons des résultats récents, obtenus en collaboration avec Hugh Thomas et Stephanie van Willigenburg [1], qui permettent de déterminer légalité de deux fonctions Schur ruban.*

### Extended Abstract

An important basis for the space of symmetric functions of degree  $n$  is the set of classical Schur functions  $s_\lambda$ , where  $\lambda$  runs over all partitions of  $n$ . For example, the skew Schur functions  $s_{\lambda/\mu}$  can be expressed in terms of these by means of the Littlewood-Richardson coefficients  $c_{\mu\nu}^\lambda$  by

$$s_{\lambda/\mu} = \sum_{\nu} c_{\mu\nu}^\lambda s_\nu.$$

These same coefficients give the expressions for the product of two Schur functions, as well as the multiplicity of irreducible representations of the symmetric group in the tensor product of two irreducibles. Thus there is some interest in determining relations among the  $c_{\mu\nu}^\lambda$ .

A particular type of skew Schur functions are those corresponding to *ribbon* or *border strip* shapes  $\lambda/\mu$ . These are connected shapes with no  $2 \times 2$  square. The resulting skew Schur functions  $s_{\lambda/\mu}$  are called *ribbon Schur functions*.

Ribbons of size  $n$  are in one-to-one correspondence with compositions  $\beta$  of size  $n$  by setting  $\beta_i$  equal to the number of boxes in the  $i$ -th row from the bottom. For example, the skew diagram 422/11

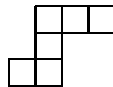

is a ribbon, corresponding to the composition 213. We will henceforth indicate ribbon Schur functions by means of the compositions corresponding to their ribbon shapes. Thus  $s_{422/11}$  will be denoted  $s_{213}$ .

We address the question of when two ribbon Schur functions are identical; that is, for compositions  $\beta$  and  $\gamma$  of  $n$ , when is it true that  $s_\beta = s_\gamma$ ? When equality holds, we automatically get Littlewood-Richardson

---

1991 *Mathematics Subject Classification.* Primary 05E05, 05A17; Secondary 05A19, 05E10.

*Key words and phrases.* ribbon Schur function, Littlewood-Richardson coefficients, compositions, partitions.

Research partially supported by NSF grant DMS-0100323.

coefficient identities of the form

$$c_{\mu,\nu}^\lambda = c_{\eta,\nu}^\rho$$

for all partitions  $\nu$  of  $n$ , whenever ribbon skew shapes  $\lambda/\mu$  and  $\rho/\eta$  correspond to  $\beta$  and  $\gamma$ .

To this end, we define an equivalence relation on the set of compositions of  $n$ . For  $\beta \vDash n$ , let  $F_\beta$  denote the fundamental quasisymmetric function indexed by  $\beta$ . (In [2], these functions are denoted  $L_\beta$ .) Since the  $F_\beta$ ,  $\beta \vDash n$ , form a basis for the quasisymmetric functions of degree  $n$ , any *symmetric* function, in particular, can be written  $F = \sum_{\beta \vDash n} c_\beta F_\beta$ .

**Definition 1.1.** For compositions  $\beta, \gamma \vDash n$ , we say  $\beta$  and  $\gamma$  are *equivalent*, denoted  $\beta \sim \gamma$ , if for all symmetric functions  $F = \sum c_\alpha F_\alpha$ ,  $c_\beta = c_\gamma$ .

For a composition  $\alpha$ , we denote by  $\lambda(\alpha)$  the unique partition whose parts are the components of  $\beta$  in weakly decreasing order. We write  $\alpha \geq \beta$  if  $\alpha$  is a *coarsening* of  $\beta$ , that is,  $\alpha$  is obtained from  $\beta$  by adding consecutive components. If  $\beta \vDash n$  then always  $n \geq \beta$ . Let  $\mathcal{M}(\beta)$  be the *multiset* of partitions determined by all coarsenings of  $\beta$ , that is,

$$\mathcal{M}(\beta) = \{\lambda(\alpha) \mid \alpha \geq \beta\}.$$

It is easy to see that  $\mathcal{M}(\beta) = \mathcal{M}(\beta^*)$ , where  $\beta^*$  is the reversal of the composition  $\beta$ .

Finally, we define a way of composing two compositions as follows. If  $\alpha \vDash n$  and  $\beta \vDash m$ , then we wish to define  $\alpha \circ \beta \vDash nm$ . Let  $\beta = \beta_1 \beta_2 \cdots \beta_k$ . For  $\alpha = n$ , then  $\alpha \circ \beta = n \circ \beta$  is the composition

$$\underbrace{\beta_1 \cdots \beta_{k-1} (\beta_k + \beta_1) \beta_2 \cdots (\beta_k + \beta_1) \beta_2 \cdots \beta_k}_{n \text{ times}}$$

which is nearly the concatenation of  $n$  copies of the composition  $\beta$ , except each pair of adjacent terms  $\beta_k \beta_1$  are added. For  $\alpha = \alpha_1 \alpha_2 \cdots \alpha_l$ , then  $\alpha \circ \beta$  is the usual concatenation of the  $l$  compositions  $\alpha_i \circ \beta$ :

$$\alpha \circ \beta = \alpha_1 \circ \beta \cdot \alpha_2 \circ \beta \cdots \alpha_l \circ \beta.$$

For example  $12 \circ 12 = 12132$ .

Our main result is

**Theorem 1.2.** *The following are equivalent for a pair of compositions  $\beta, \gamma \vDash n$ :*

- (1)  $s_\beta = s_\gamma$ ,
- (2)  $\beta \sim \gamma$
- (3)  $\mathcal{M}(\beta) = \mathcal{M}(\gamma)$ ,
- (4) *for some  $k$ ,*

$$\beta = \beta_1 \circ \beta_2 \circ \cdots \circ \beta_k \quad \text{and} \quad \gamma = \gamma_1 \circ \gamma_2 \circ \cdots \circ \gamma_k,$$

*and, for each  $i$ , either  $\gamma_i = \beta_i$  or  $\gamma_i = \beta_i^*$ .*

Thus, for example,  $s_{12132} = s_{13212} = s_{23121} = s_{21231}$ , and these four equal no others.

The last condition shows that the size of the equivalence class of  $\beta$  is  $2^r$ , where  $r$  is the number of nonpalindromic factors in the unique nontrivial irreducible factorization of  $\beta$ . We always have, for example, that  $s_\beta = s_{\beta^*}$ .

## References

- [1] L.J. Billera, H. Thomas and S. van Willigenburg, Decomposable Compositions, Symmetric Quasisymmetric Functions and Equality of Ribbon Schur Functions, preprint, May 2004.
- [2] R. Stanley, *Enumerative Combinatorics, Vol. 2*, Cambridge Studies in Advanced Mathematics, Vol. 62, Cambridge University Press, Cambridge, UK, 1999.

DEPARTMENT OF MATHEMATICS, CORNELL UNIVERSITY, ITHACA, NEW YORK, 14853-4201 USA  
E-mail address: billera@math.cornell.edu





## Intersecting Schubert Varieties

Sara Billey

In the late 1800's, H. Schubert was studying classical intersections of linear subspace arrangements. A typical *Schubert problem* asks how many lines in  $\mathbb{C}^3$  generically meet 4 given lines? The generic answer, 2, can be obtained by doing a computation in the cohomology ring of the Grassmannian variety of 2-dimensional planes in  $\mathbb{C}^4$ . During the past century, the study of the Grassmannian has been generalized to the flag manifold where one can ask similar questions in enumerative geometry.

The flag manifold  $\mathcal{F}_n(\mathbb{C}^n)$  consists of all complete flags  $F_i = F_1 \subset F_2 \subset \cdots \subset F_n = \mathbb{C}^n$  where  $F_i$  is a vector space of dimension  $i$ . A modern Schubert problem asks how many flags have relative position  $u, v, w$  to three fixed flags  $X_i, Y_i$  and  $Z_i$ . The solution to this problem used over the past twenty years, due to Lascoux and Schützenberger, is to compute a product of Schubert polynomials and expand in the basis of Schubert polynomials. The coefficient indexed by  $u, v, w$  is the solution. This represents a computation in the cohomology ring of the flag variety. It has been a long standing open problem to give a combinatorial rule for expanding these products proving the coefficients  $c_{u,v,w}$  are nonnegative integers. It is known from the geometry that these coefficients are nonnegative because they count the number of points in a triple intersection of Schubert varieties with respect to three generic flags.

The main goal of this talk is to describe a method for directly identifying all flags in  $X_u(F_i) \cap X_v(G_i) \cap X_w(H_i)$  when  $\ell(u) + \ell(v) + \ell(w) = \binom{n}{2}$  and  $F_i, G_i, H_i$  are generic, thereby computing  $c_{u,v,w}$  explicitly. In 2000, Eriksson and Linusson have shown that the rank tables of intersecting flags are determined by a combinatorial structure they call *permutation arrays*. We prove there is a unique permutation array for each nonempty 0-dimensional intersection of Schubert varieties with respect to flags in generic position. Then we use the structure of this permutation array to solve a small subset of the rank equations previously needed to identify flags in the given intersection. These equations are also useful for determining monodromy and Galois groups on specified collections of flags. This is joint work with Ravi Vakil at Stanford University.





## Alexander Duality in Combinatorics

Takayuki Hibi

Alexander duality theorem plays a vital role in [7] to show that the second Betti number of the minimal graded resolution of the Stanley–Reisner ring  $K[\Delta]$  of a simplicial complex  $\Delta$  is independent of the base field  $K$ . On the other hand, a beautiful theorem by Eagon and Reiner [2] guarantees that the Stanley–Reisner ideal  $I_\Delta$  of  $\Delta$  has a linear resolution if and only if the Alexander dual  $\Delta^\vee$  of  $\Delta$  is Cohen–Macaulay.

With a survey of the recent papers [3], [4], [5] and [6], my talk will demonstrate how Alexander duality is used in algebraic combinatorics. More precisely,

- Let  $\mathcal{L}$  be a finite meet-semilattice,  $P$  the set of join-irreducible elements of  $\mathcal{L}$ , and  $K[\{x_q, y_q\}_{q \in P}]$  the polynomial ring over a field  $K$ . We associate each  $\alpha \in \mathcal{L}$  with the squarefree monomial  $u_\alpha = \prod_{q \leq \alpha} x_q \prod_{q \not\leq \alpha} y_q$ . Let  $\Delta_{\mathcal{L}}$  denote the simplicial complex on  $\{x_q, y_q\}_{q \in P}$  whose Stanley–Reisner ideal is generated by those monomials  $u_\alpha$  with  $\alpha \in \mathcal{L}$ . In the former part of my talk, combinatorics and algebra on the Alexander dual  $\Delta_{\mathcal{L}}^\vee$  of  $\Delta_{\mathcal{L}}$  will be discussed.
- One of the fascinating results in classical graph theory is Dirac’s theorem on chordal graphs ([1]). In the latter part of my talk, it will be shown that, via Hilbert–Burch theorem together with Eagon–Reiner theorem, Alexander duality naturally yields a new and algebraic proof of Dirac’s theorem.

No special knowledge is required to enjoy my talk.

### References

- [1] G. A. Dirac, On rigid circuit graphs, *Abh. Math. Sem. Univ. Hamburg* **25** (1961), 71 – 76.
- [2] J. A. Eagon and V. Reiner, Resolutions of Stanley–Reisner rings and Alexander duality, *J. Pure and Appl. Algebra* **130** (1998), 265 – 275.
- [3] J. Herzog and T. Hibi, Distributive lattices, bipartite graphs and Alexander duality, preprint, June 2003, math.AC/0307235.
- [4] J. Herzog and T. Hibi, Level rings arising from meet-distributive meet-semilattices, preprint, March 2004, math.AC/0403534.
- [5] J. Herzog, T. Hibi and X. Zheng, Dirac’s theorem on chordal graphs and Alexander duality, *Europ. J. Combin.*, to appear, math.AC/0307224.
- [6] J. Herzog, T. Hibi and X. Zheng, The monomial ideal of a finite meet-semilattice, preprint, November 2003, math.AC/0311112.
- [7] N. Terai and T. Hibi, Alexander duality theorem and second Betti numbers of Stanley–Reisner rings, *Adv. Math.* **124** (1996), 332 – 333.

OSAKA UNIVERSITY, DEPARTMENT OF PURE AND APPLIED MATHEMATICS, GRADUATE SCHOOL OF INFORMATION SCIENCE AND TECHNOLOGY, OSAKA UNIVERSITY, TOYONAKA, OSAKA 560-0043, JAPAN





## Sums of polynomials from degeneration in algebraic geometry

Allen Knutson

Many interesting polynomials with positive coefficients are the “multidegrees” of (irreducible) algebraic varieties. We need to break these unbreakable objects, as we’d like to have formulae for these polynomials as positive sums; this breakage can be achieved through degeneration of the defining polynomials (as of a conic to the union of two lines, giving the degree formula  $2=1+1$ ).

I’ll give many examples related to Schubert varieties, and explain how the geometry of the degeneration helps control the combinatorics, in suggesting shellings of related simplicial complexes. This work is joint with Ezra Miller and Alex Yong.

DEPARTMENT OF MATHEMATICS, UNIVERSITY OF CALIFORNIA AT BERKELEY  
*E-mail address:* [allenk@math.berkeley.edu](mailto:allenk@math.berkeley.edu)



## Operads and combinatorics

Jean-Louis Loday

In some problems it is necessary to consider series indexed, not by integers, but by some other combinatorial objects like trees for instance. In order to multiply and compose these series one needs to be able to add trees and to multiply them. Most of the time the structure which unravel these constructions is a new type of algebras, or, equivalently, an *operad*.

For instance, consider the algebras equipped with two binary operations  $\prec$ , called *left*, and  $\succ$ , called *right*, satisfying the following relations

$$\begin{cases} (x \prec y) \prec z = x \prec (y * z), \\ (x \succ y) \prec z = x \succ (y \prec z), \\ (x * y) \succ z = x \succ (y \succ z), \end{cases}$$

where  $x * y := x \prec y + x \succ y$ . They are called *dendriform algebras* (cf. [L1]). It can be shown that the free dendriform algebra on one generator is the vector space spanned by the planar binary rooted trees. The two products are described by means of grafting. From this result we can construct a product and a composition on the series  $\sum_t a(t)x^t$ , where the sum runs over the planar binary rooted trees (no constant term). For the product we simply use the fact that the product  $*$  in a dendriform algebra is associative (check it !). For the composition we use the explicit description of the free dendriform algebra. In fact these series form a group for composition. This is the *renormalisation group* of Quantum Electro-Dynamics.

There are several examples of this type, few of them have been studied so far.

There are many more problems where operads can help in combinatorics. Let me just mention two of them. A free algebra of some sort is, in general, graded and one can form its generating series. In terms of operads, when the space of  $n$ -ary operations  $\mathcal{P}(n)$  is finite dimensional one defines

$$f^{\mathcal{P}}(x) := \sum_{n \geq 1} (-1)^n \frac{\dim \mathcal{P}(n)}{n!} x^n .$$

An important theory in the operad framework is the Koszul duality. Well-known for associative algebras it has been generalized to operads by Ginzburg and Kapranov (cf. [G-K], [F], see [L1] appendix 2 for a short overview on operads and Koszul duality). One of the consequences is the following. To any quadratic operad  $\mathcal{P}$  one can associate its dual  $\mathcal{P}^!$  and a certain chain complex, called the Koszul complex. When the Koszul complex is acyclic, then the generating series of  $\mathcal{P}$  and  $\mathcal{P}^!$  are inverse to each other for composition:

$$f^{\mathcal{P}}(f^{\mathcal{P}^!}(x)) = x .$$

This nice theorem has many applications. One of them is, in some instances, to provide a combinatorial interpretation of some integer sequences (cf. [L2]).

Here is another application. The partition lattice gives rise to a chain complex whose homology is a representation of the symmetric group. It is not that easy to compute. However there is an operadic way of looking at it, which, by using Koszul duality, permits us to identify this homology group to the space of operations of a dual operad (cf. [F]). This interpretation can be generalized to many variations of the classical partition lattice provided that the operad involved is Koszul (cf. [V1]).

If, instead of looking only at operations, we want look at operations *and* co-operations, then the notion of operad has to be replaced by the notion of *prop*. At this point there is a need for a Koszul duality theory in the prop framework. This has recently been achieved in [V2].

### References

- [F] B. Fresse, *Koszul duality of operads and homology of partition posets*, Proceedings of the Conference on Algebraic Topology, Northwestern University, Contemporary Mathematics, AMS, to appear. e-print [arXiv:math.AT/0301365](https://arxiv.org/abs/math/0301365) (2003).
- [G-K] V. Ginzburg, M.M. Kapranov, *Koszul duality for operads*, Duke Math. J. **76** (1995), 203-272.
- [L1] J.-L. Loday, *Dialgebras*, “Dialgebras and related operads”, 7–66, Lecture Notes in Math., 1763, Springer, Berlin, 2001.
- [L2] J.-L. Loday, *Inversion of integral series enumerating planar trees*, e-print [arXiv:math.CO/0403316](https://arxiv.org/abs/math/0403316)
- [V1] B. Vallette, *Homology of generalized partition posets*, preprint IRMA, 2004.
- [V2] B. Vallette, *Koszul duality for PROPs* e-print [arXiv:math.AT/0402213](https://arxiv.org/abs/math/0402213)

INSTITUT DE RECHERCHE MATHÉMATIQUE AVANCÉE, CNRS ET UNIVERSITÉ LOUIS PASTEUR, 7 RUE R. DESCARTES, 67084 STRASBOURG CEDEX, FRANCE  
*E-mail address:* [loday@math.u-strasbg.fr](mailto:loday@math.u-strasbg.fr)  
*URL:* [www-irma.u-strasbg.fr/~loday/](http://www-irma.u-strasbg.fr/~loday/)





## Asymptotics of multivariate generating functions

Robin Pemantle

Let  $F(\mathbf{x}) = \sum_{\mathbf{r}} a_{\mathbf{r}} \mathbf{x}^{\mathbf{r}}$  be the multivariate generating function encoding the coefficients  $\mathbf{r} := (r_1, \dots, r_d)$ . We would like to find estimates for the coefficients  $\{a_{\mathbf{r}}\}$  that are asymptotically valid as  $\mathbf{r} \rightarrow \infty$ . In the univariate case, there is a well known, powerful, elegant apparatus for deriving such asymptotics from the analytic behavior of  $F$  near its minimal modulus singularity. In more than one variable, this problem is nearly untouched. Writing  $F = \sum g_n(r_1, \dots, r_{d-1}) z_d^{r_d}$ , if  $g_n$  is asymptotically  $g^n$  for some  $g$ , then theorems by Bender, Richmond, Canfield and Gao yield Gaussian limit laws for  $a_{\mathbf{r}}$ . No other general results appear to be known.

The present talk will focus on the case of rational generating functions. In the one variable case this class is trivial to analyze, but in the multivariate case even this class poses many unsolved problems. Furthermore, one finds numerous applications within this class. The approach is to write  $a_{\mathbf{r}}$  as a multivariate Cauchy integral, and then to use topological techniques to replace this integral with one that is in stationary phase, meaning that it looks locally like  $\int_D A(\mathbf{x}) \exp(-|\mathbf{r}|Q(\mathbf{x})) d\mathbf{x}$  for some (one hopes positive definite) quadratic form on a disk-like domain,  $D$ . Asymptotics can then be read off in a fairly automated way. It is our extreme good fortune that existing results in Stratified Morse Theory are tailor-made to convert the Cauchy integral to the stationary phase integral. A more complete outline of the steps is as follows. This outline is valid for certain geometries of the pole set of  $F$ .

- (1) Write  $a_{\mathbf{r}}$  as a Cauchy integral

$$(1) \quad a_{\mathbf{r}} = \left( \frac{1}{2\pi i} \right)^d \int_T \mathbf{z}^{-\mathbf{r}} F(\mathbf{z}) \frac{d\mathbf{z}}{\mathbf{z}}$$

where the torus  $T$  is a product of sufficiently small circles around the origin in each coordinate.

- (2) The torus  $T$  may be replaced by an equivalent  $d$ -cycle in the homology of  $(\mathbb{C}^*)^d$  minus the poles of  $F$ . Specifically, we denote by  $-\infty$  the set where the integrand in (1) is sufficiently small, and represent  $T$  in the homology of  $(\mathbb{C}^*)^d$  minus the poles of  $F$ , relative to  $-\infty$ .
- (3) Stratified Morse theory identifies the other homology classes with saddles of the gradient  $\mathbf{r} \log \mathbf{z}$  of the function  $\mathbf{z}^{\mathbf{r}}$ . Each such saddle lives in a stratum of dimension  $j < d$  and yields a contribution which is an integral over a product of a cycle  $\beta_{\text{cyc}}^{\parallel}$  in the stratum with a cycle  $\beta_{\text{cyc}}^{\perp}$  in a transversal to the stratum.
- (4) A nonzero contribution at a saddle  $\sigma$  occurs when the vector  $\mathbf{r}$  is in a certain positive cone determined by the geometry of the pole set of  $F$  near  $\sigma$ .
- (5) The integral over  $\beta_{\text{cyc}}^{\perp}$  is equal to an easily computed spline, and the integral over  $\beta_{\text{cyc}}^{\parallel}$  is then asymptotically evaluated by the saddle point method.

### References

- [1] Pemantle, R. and Wilson, M. (2002). Asymptotics of multivariate sequences, part I: smooth points of the singular variety. *JCT A* **97**, 129–161.  
<http://www.math.upenn.edu/~pemantle/papers/p1.ps>
- [2] Pemantle, R. and Wilson, M. (2004). Asymptotics of multivariate sequences, part II: Multiple points of the singular variety. *Comb. Prob. Comput., to appear*.  
<http://www.math.upenn.edu/~pemantle/papers/Preprints/multiplepoints.ps>
- [3] Baryshnikov, Y. and Pemantle, R. (2004). Convolutions of inverse linear functions via multivariate residues. *In Preparation*.  
<http://www.math.upenn.edu/~pemantle/papers/Preprints/arrangements.ps>

UNIVERSITY OF PENNSYLVANIA  
*E-mail address:* [pemantle@math.upenn.edu](mailto:pemantle@math.upenn.edu)



## Virtual Crystals and the $X = M$ Conjecture

Anne Schilling

**Abstract.** *This is an expository talk on virtual crystals and the  $X = M$  conjecture.*

**Résumé.** *C'est un entretien expositoire sur les cristaux virtuels et la conjecture  $X = M$ .*

### 1. Extended Abstract

The quantized universal enveloping algebra  $U_q(\mathfrak{g})$  associated with a symmetrizable Kac–Moody Lie algebra  $\mathfrak{g}$  was introduced independently by Drinfeld [D] and Jimbo [J] in their study of two dimensional solvable lattice models in statistical mechanics. The parameter  $q$  corresponds to the temperature of the underlying model. Kashiwara [K] showed that at zero temperature or  $q = 0$  the representations of  $U_q(\mathfrak{g})$  have bases, which he coined crystal bases, with a beautiful combinatorial structure and favorable properties such as uniqueness and stability under tensor products.

The irreducible finite-dimensional  $U'_q(\mathfrak{g})$ -modules were classified by Chari and Pressley [CP1, CP2] in terms of Drinfeld polynomials. The Kirillov–Reshetikhin modules  $W^{r,s}$ , labeled by a Dynkin node  $r$  and a positive integer  $s$ , form a special class of these finite-dimensional modules. They naturally correspond to the weight  $s\Lambda_r$ , where  $\Lambda_r$  is the  $r$ -th fundamental weight of  $\mathfrak{g}$ . Recently, Hatayama et al. [HKOTY, HKOTT] conjectured that the Kirillov–Reshetikhin modules  $W^{r,s}$  have a crystal basis denoted by  $B^{r,s}$ . The existence of such crystals allows the definition of one dimensional configuration sums  $X$ , which play an important role in the study of phase transitions of two dimensional exactly solvable lattice models. For  $\mathfrak{g}$  of type  $A_n^{(1)}$ , the existence of the crystal  $B^{r,s}$  was settled in [KKMMNN], and the one dimensional configuration sums contain the Kostka polynomials, which arise in the theory of symmetric functions, combinatorics, the study of subgroups of finite abelian groups, and Kazhdan–Lusztig theory. In certain limits they are branching functions of integrable highest weight modules.

In [HKOTY, HKOTT] fermionic formulas  $M$  for the one dimensional configuration sums were conjectured. Fermionic formulas originate in the Bethe Ansatz of the underlying exactly solvable lattice model. The term fermionic formula was coined by the Stony Brook group [KKMM1, KKMM2], who interpreted fermionic-type formulas for characters and branching functions of conformal field theory models as partition functions of quasiparticle systems with “fractional” statistics obeying Pauli’s exclusion principle. For type  $A_n^{(1)}$  the fermionic formulas were proven in [KSS] using a generalization of a bijection between crystals and rigged configurations of Kirillov and Reshetikhin [KR]. In [OSS2] similar bijections were used to prove the fermionic formula for nonexceptional types for crystals  $B^{1,1}$ . Rigged configurations are combinatorial objects which label the solutions to the Bethe equations. The bijection between crystals and rigged configurations

---

2000 *Mathematics Subject Classification.* Primary 05-06; Secondary 05A19, 17B37, 17B65, 81R10, 81R50, 82B23.

*Key words and phrases.* crystal bases, rigged configurations, fermionic formulas.

Supported in part by the NSF grant DMS-0200774.

reflects two different methods to solve lattice models in statistical mechanics: the corner-transfer-matrix method and the Bethe Ansatz.

The theory of virtual crystals [OSS1, OSS3] provides a realization of crystals of type  $X$  as crystals of type  $Y$ , based on well-known natural embeddings  $X \hookrightarrow Y$  of affine algebras:

$$\begin{aligned} C_n^{(1)}, A_{2n}^{(2)}, A_{2n}^{(2)\dagger}, D_{n+1}^{(2)} &\hookrightarrow A_{2n-1}^{(1)} \\ A_{2n-1}^{(2)}, B_n^{(1)} &\hookrightarrow D_{n+1}^{(1)} \\ E_6^{(2)}, F_4^{(1)} &\hookrightarrow E_6^{(1)} \\ D_4^{(3)}, G_2^{(1)} &\hookrightarrow D_4^{(1)}. \end{aligned}$$

Note that under these embeddings every affine Kac–Moody algebra is embedded into one of simply-laced type  $A_n^{(1)}$ ,  $D_n^{(1)}$  or  $E_6^{(1)}$ . Hence, by the virtual crystal method the combinatorial structure of any finite-dimensional affine crystal can be expressed in terms of the combinatorial crystal structure of the simply-laced types. Whereas the affine crystals  $B^{r,s}$  of type  $A_n^{(1)}$  are already well-understood [Sh], this is not the case for  $B^{r,s}$  of types  $D_n^{(1)}$  and  $E_6^{(1)}$ .

In this talk we highlight the main results regarding the  $X = M$  conjecture of [HKOTY, HKOTT] and virtual crystals [OSS1, OSS3], which can be summarized as follows:

- Refs. [HKOTY, HKOTT] conjecture the existence of  $B^{r,s}$  and the identity  $X = M$  for general affine Kac-Moody algebras.
- Refs. [OSS1, OSS3] introduce the virtual crystal method which yields a description of the combinatorial structure of the crystals  $B^{r,s}$  in terms of the combinatorics of  $B^{r,s}$  for types  $A_n^{(1)}$ ,  $D_n^{(1)}$  and  $E_6^{(1)}$ . Similarly, the fermionic formulas and rigged configurations also exhibit this virtual embedding structure. In [OSS3] this was used in particular to extend the Kleber algorithm, which provides an efficient algorithm for calculating fermionic formulas, to nonsimply-laced algebras.
- In Ref. [KSS] the  $X = M$  conjecture was proven for type  $A_n^{(1)}$  using a bijection between crystals/tableaux and rigged configurations. This was extended to other nonexceptional types in [OSS2] for tensor products of  $B^{1,1}$  and in [SSh] for tensor products of  $B^{1,s}$ . Type  $D_n^{(1)}$  for tensor products of  $B^{r,1}$  was treated in [S].
- The combinatorial structure of the crystals  $B^{2,s}$  of type  $D_n^{(1)}$  is studied in [SS]. This work is presented by Philip Sternberg in form of a poster at this conference.

## References

- [CP1] V. Chari and A. Pressley, *Quantum affine algebras and their representations*, Representations of groups (Banff, AB, 1994), 59–78, CMS Conf. Proc., **16**, Amer. Math. Soc., Providence, RI, 1995.
- [CP2] V. Chari and A. Pressley, *Twisted quantum affine algebras*, Comm. Math. Phys. **196** (1998) 461–476.
- [D] V. G. Drinfeld, *Hopf algebra and the Yang–Baxter equation*, Soviet. Math. Dokl. **32** (1985) 254–258.
- [HKOTT] G. Hatayama, A. Kuniba, M. Okado, T. Takagi and Z. Tsuboi, *Paths, crystals and fermionic formulae*, Prog. Math. Phys. **23** (2002) 205–272, Birkhäuser Boston, Boston, MA.
- [HKOTY] G. Hatayama, A. Kuniba, M. Okado, T. Takagi and Y. Yamada, *Remarks on fermionic formula*, Contemp. Math. **248** (1999) 243–291.
- [J] M. Jimbo, *A  $q$ -difference analogue of  $U(\mathcal{G})$  and the Yang–Baxter equation*, Lett. Math. Phys. **10** (1985) 63–69.
- [K] M. Kashiwara, *Crystalizing the  $q$ -analogue of universal enveloping algebras*, Commun. Math. Phys. **133** (1990) 249–260.
- [KKMM1] R. Kedem, T. R. Klassen, B. M. McCoy, E. Melzer, *Fermionic quasi-particle representations for characters of  $(G^{(1)})_1 \times (G^{(1)})_1 / (G^{(1)})_2$* , Phys. Lett. B **304** (1993), no. 3–4, 263–270.
- [KKMM2] R. Kedem, T. R. Klassen, B. M. McCoy, E. Melzer, *Fermionic sum representations for conformal field theory characters*, Phys. Lett. B **307** (1993), no. 1–2, 68–76.
- [KKMMNN] S.-J. Kang, M. Kashiwara, K. C. Misra, T. Miwa, T. Nakashima and A. Nakayashiki, *Perfect crystals of quantum affine Lie algebras*, Duke Math. J. **68** (1992) 499–607.

- [KR] A. N. Kirillov and N. Y. Reshetikhin, *The Bethe ansatz and the combinatorics of Young tableaux*, (Russian) Zap. Nauchn. Sem. Leningrad. Otdel. Mat. Inst. Steklov. (LOMI) **155** (1986), *Differentsialnaya Geometriya, Gruppy Li i Mekh.* VIII, 65–115, 194; translation in J. Soviet Math. **41** (1988), no. 2, 925–955.
- [KSS] A. N. Kirillov, A. Schilling and M. Shimozono, *A bijection between Littlewood-Richardson tableaux and rigged configurations*, *Selecta Mathematica (N.S.)* **8** (2002) 67–135.
- [OSS1] M. Okado, A. Schilling and M. Shimozono, *Virtual crystals and fermionic formulas of type  $D_{n+1}^{(2)}$ ,  $A_{2n}^{(2)}$ , and  $C_n^{(1)}$* , *Representation Theory* **7** (2003) 101–163.
- [OSS2] M. Okado, A. Schilling and M. Shimozono, *A crystal to rigged configuration bijection for nonexceptional affine algebras*, "Algebraic Combinatorics and Quantum Groups", Edited by N. Jing, World Scientific (2003), 85–124.
- [OSS3] M. Okado, A. Schilling and M. Shimozono, *Virtual crystals and Kleber's algorithm*, *Commun. Math. Phys.* **238** (2003) 187–209.
- [S] A. Schilling, *A bijection between type  $D_n^{(1)}$  crystals and rigged configurations*, preprint 2004.
- [Sh] M. Shimozono, *Affine type A crystal structure on tensor products of rectangles, Demazure characters, and nilpotent varieties*, *J. Algebraic Combin.* **15** (2002), no. 2, 151–187.
- [SS] A. Schilling and P. Sternberg, *Finite-dimensional crystals for quantum affine algebras of type  $D_n^{(1)}$* , in preparation.
- [Ssh] A. Schilling and M. Shimozono, *On the  $X = M$  conjecture*, in preparation.

DEPARTMENT OF MATHEMATICS, UNIVERSITY OF CALIFORNIA, ONE SHIELDS AVE, DAVIS, CA 951616, USA  
*E-mail address:* [anne@math.ucdavis.edu](mailto:anne@math.ucdavis.edu)  
*URL:* <http://www.math.ucdavis.edu/~anne>





## The Phase Transition for Random Subgraphs of the $n$ -cube

Gordon Slade

**Abstract.** *We describe recent results, obtained in collaborations with C. Borgs, J.T. Chayes, R. van der Hofstad and J. Spencer, which provide a detailed description of the phase transition for random subgraphs of the  $n$ -cube.*

**Résumé.** *Nous présentons des résultats récents qui donnent une description détaillée de la transition de phase des sous-graphes aléatoires du  $n$ -cube. Ces résultats sont obtenus en collaboration avec C. Borgs, J.T. Chayes, R. van der Hofstad et J. Spencer.*

### Extended Abstract

The phase transition for random subgraphs of the complete graph, or the *random graph* for short, was first studied by Erdős and Rényi [7], and has been analyzed in considerable detail since then [2, 11]. Let  $K_V$  denote the complete graph on  $V$  vertices, so that there is an edge joining each of the  $\binom{V}{2}$  pairs of vertices. In the random graph, edges of the complete graph are independently occupied with probability  $p$  and vacant with probability  $1 - p$ , as in the bond percolation model. The occupied edges naturally determine connected components, called *clusters*. There is a phase transition as  $p$  is varied, in the sense that there is an abrupt change in the number of vertices  $|\mathcal{C}_{\max}|$  in a cluster  $\mathcal{C}_{\max}$  of maximal size, as  $p$  is varied through the critical value  $p_c = \frac{1}{V}$ .

We will say that a sequence of events  $E_V$  occurs *with high probability*, denoted w.h.p., if  $\mathbb{P}(E_V) \rightarrow 1$  as  $V \rightarrow \infty$ . The basic fact of the phase transition is that when  $p$  is scaled as  $(1 + \epsilon)V^{-1}$ , there is a phase transition at  $\epsilon = 0$  in the sense that w.h.p.

$$(1) \quad |\mathcal{C}_{\max}| = \begin{cases} \Theta(\log V) & \text{for } \epsilon < 0, \\ \Theta(V^{2/3}) & \text{for } \epsilon = 0, \\ \Theta(V) & \text{for } \epsilon > 0. \end{cases}$$

The asymptotic results of (1) are valid for fixed  $\epsilon$ , independent of  $V$ . These results have been substantially strengthened to show that there is a scaling window of width  $V^{-1/3}$ , in the sense that if  $p = (1 + \Lambda_V V^{-1/3})V^{-1}$ , then w.h.p.

$$(2) \quad |\mathcal{C}_{\max}| \begin{cases} \sim V^{2/3} & \text{for } \Lambda_V \rightarrow -\infty, \\ = \Theta(V^{2/3}) & \text{for } \Lambda_V \text{ uniformly bounded in } V, \\ \gg V^{2/3} & \text{for } \Lambda_V \rightarrow \infty. \end{cases}$$

Here, we are using the notation  $f(V) \mathbf{lg}(V)$  to mean that  $f(V)/g(V) \rightarrow 0$  as  $V \rightarrow \infty$ , while  $f(V) \gg g(V)$  means that  $f(V)/g(V) \rightarrow \infty$  as  $V \rightarrow \infty$ . A great deal more is known, and can be found in [2, 11].

---

1991 *Mathematics Subject Classification.* Primary 05C80, 60K35; Secondary 82B43.

*Key words and phrases.* random graph, phase transition,  $n$ -cube, percolation.

Research supported by an NSERC Discovery Grant.

Our goal is to understand how these results can be extended to apply to the  $n$ -cube  $\mathbb{Q}_n$ . This graph has vertex set  $\{0, 1\}^n$ , with an edge joining pairs of vertices which differ in exactly one coordinate. It has  $V = 2^n$  vertices, each of degree  $n$ . Edges are again independently occupied with probability  $p$ . If  $p = (1 + \epsilon)n^{-1}$  with  $\epsilon < 0$  independent of  $n$ , then  $|\mathcal{C}_{\max}|$  turns out to be  $\Theta(\log V)$ . On the other hand, for  $\epsilon > 0$  independent of  $n$ , it was shown in [1] that  $|\mathcal{C}_{\max}| = \Theta(V)$ . Thus, a transition takes place at the value  $\frac{1}{n}$  of  $p$ .

In [3], the results of [1] were extended to show that w.h.p.

$$(3) \quad |\mathcal{C}_{\max}| = \begin{cases} 2\epsilon^{-2} \log V (1 + o(1)) & \text{for } \epsilon \leq -(\log n)^2 (\log \log n)^{-1} n^{-1/2}, \\ 2\epsilon V & \text{for } \epsilon \geq 60(\log n)^3 n^{-1}. \end{cases}$$

Thus,  $\epsilon$  as in the first line of (3) gives a subcritical  $p$ , whereas in the second line  $p$  is supercritical. The gap between these ranges of  $p$  is much bigger than the  $V^{-1/3}$  (here  $2^{-n/3}$ ) seen above as the size of the scaling window for the complete graph.

The following result from [9, 10], which builds on results of [4, 5, 6], gives bounds for  $\epsilon$  on an arbitrary scale that is polynomial in  $n^{-1}$ .

**Theorem 1.1.** *For the  $n$ -cube, there exists a sequence of rational numbers  $a_1, a_2, a_3, \dots$ , with  $a_1 = a_2 = 1$  and  $a_3 = \frac{7}{2}$ , such that for any  $M \geq 1$ , for  $p_c^{(M)} = \sum_{i=1}^M a_i n^{-i}$ , and for  $p = p_c^{(M)} + \delta n^{-M}$  with  $\delta$  independent of  $n$ , the following bounds hold w.h.p.:*

$$(4) \quad |\mathcal{C}_{\max}| \begin{cases} \leq 2(\log 2)\delta^{-2}n^{2M-1}[1 + o(1)] & \text{for } \delta < 0, \\ \geq \text{const } \delta n^{1-M} 2^n & \text{for } \delta > 0. \end{cases}$$

More is proved in [9, 10], but (4) is highlighted here because it shows subcritical behaviour for negative  $\delta$  and supercritical behaviour for positive  $\delta$ . Theorem 1.1 suggests that the critical value for the  $n$ -cube should be  $\sum_{i=1}^{\infty} a_i n^{-i}$ , but circumstantial evidence leads us to conjecture that this infinite series is divergent (see [8] for a general discussion of such issues). If the conjecture is correct, the critical value cannot be defined in this way. This difficulty was bypassed in [4], where the critical value for the phase transition on a ‘‘high-dimensional’’ finite graph  $\mathbb{G}$  was defined to be the value  $p_c = p_c(\mathbb{G}, \lambda)$  for which

$$(5) \quad \chi(p_c) = \lambda V^{1/3},$$

where  $\chi(p)$  is by definition the expected number of vertices in the component of an arbitrary fixed vertex (e.g., the origin of the  $n$ -cube),  $V$  is the number of vertices in the graph  $\mathbb{G}$ , and  $\lambda$  is a fixed positive number. This definition is by analogy with the random graph, where it is known that  $\chi(1/V) = \Theta(V^{1/3})$ . The parameter  $\lambda$  allows for some flexibility, associated with the fact that criticality corresponds to a scaling window of finite width and not to a single point. The following theorem is proved in [10], building on results in [4, 5, 6].

**Theorem 1.1.** *For the  $n$ -cube, let  $M \geq 1$ , fix constants  $c, c'$  (independent of  $n$  but possibly depending on  $M$ ), and choose  $p$  such that  $\chi(p) \in [cn^M, c'n^{-2M}2^n]$ . Then for  $a_i$  given by Theorem 1.1,*

$$(6) \quad p = \sum_{i=1}^M a_i n^{-i} + O(n^{-M-1}) \quad \text{as } n \rightarrow \infty.$$

The constant in the error term depends on  $M, c, c'$ , but does not depend otherwise on  $p$ .

Fix  $\lambda > 0$  independent of  $n$ . Then  $\chi(p_c(\mathbb{Q}_n, \lambda)) = \lambda 2^{n/3}$  is in an interval  $[cn^M, c'n^{-2M}2^n]$  for every  $M$ , with  $c, c'$  dependent on  $M$  and  $\lambda$ . By Theorem 1.1, (6) holds for  $p = p_c(\mathbb{Q}_n, \lambda)$ , for every fixed choice of  $\lambda$  and for every  $M$ . Thus,

$$(7) \quad p_c(\mathbb{Q}_n, \lambda) \sim \sum_{i=1}^{\infty} a_i n^{-i}$$

is an asymptotic expansion for  $p_c(\mathbb{Q}_n, \lambda)$ , for every positive  $\lambda$ .



By analogy with the complete graph, we would like to prove that the critical scaling window for the  $n$ -cube has size  $V^{-1/3} = 2^{-n/3}$ . This exponential scale is not accessible using the asymptotic expansion of Theorems 1.1–1.1. The following result from [6], which builds on the results of [4, 5], does not quite prove that the scaling window has size  $2^{-n/3}$ , but does show that it is smaller than any inverse power of  $n$ .

**Theorem 1.2.** *For the  $n$ -cube, let  $V = 2^n$ , let  $\lambda_0$  be a fixed sufficiently small constant, and let  $p = p_c(\mathbb{Q}_n, \lambda_0) + \epsilon n^{-1}$ . If  $\epsilon < 0$  and  $\epsilon V^{1/3} \rightarrow -\infty$  as  $V \rightarrow \infty$ , then w.h.p.*

$$(8) \quad |\mathcal{C}_{\max}| \leq 2\epsilon^{-2} \log V(1 + o(1)).$$

If  $|\epsilon|V^{1/3} \leq B$  for some constant  $B$ , then there is a constant  $b$  (depending on  $B$  and  $\lambda_0$ ) such that, for any  $\omega \geq 1$ ,

$$(9) \quad \mathbb{P}\left(\omega^{-1}V^{2/3} \leq |\mathcal{C}_{\max}| \leq \omega V^{2/3}\right) \geq 1 - \frac{b}{\omega}.$$

Finally, there are positive constants  $c, c_1$  such that if  $e^{-cn^{1/3}} \leq \epsilon \leq 1$  then w.h.p.

$$(10) \quad |\mathcal{C}_{\max}| \geq c_1 \epsilon V.$$

Additional estimates can be found in [6], but those in Theorem 1.2 show that the critical window in  $\epsilon$  is of size  $V^{-1/3} = 2^{-n/3}$  on the subcritical side of  $p_c(n)$ , and has at most size  $e^{-cn^{1/3}}$  on the supercritical side. We expect that the window actually has size  $V^{-1/3} = 2^{-n/3}$  on both sides of  $p_c(n)$ , and that, more generally, the scaling window in high-dimensional graphs has size  $V^{-1/3}$ .

An interesting consequence of the above theorems is that the approximate critical values  $p_c^{(M)} = \sum_{i=1}^M a_i n^{-i}$  will lie outside the critical window around  $p_c(\mathbb{Q}_n, \lambda)$ , for every  $M$ , unless the sequence  $a_i$  is eventually zero and the asymptotic series is actually a polynomial in  $n^{-1}$ . We expect the series to be divergent, and not a polynomial. We regard the definition (5) as superior to any definition based on the asymptotic expansion. In particular, the coefficients  $a_i$  are obtained from an asymptotic expansion for  $p_c(\mathbb{Q}_n, \lambda)$ , so the latter contains all information contained in the former.

There are several ingredients in the proof of these theorems, most of which are more familiar in mathematical physics than in combinatorics. These include differential inequalities, the triangle condition, finite-size scaling ideas, and the lace expansion. The method of [1], which we call sprinkling, is used in conjunction with estimates obtained via these other methods to prove the lower bound (10). In [4, 5], other graphs besides the  $n$ -cube are also treated, including finite periodic approximations to  $\mathbb{Z}^n$  for  $n$  large, with less complete results.

## References

- [1] M. Ajtai, J. Komlós, and E. Szemerédi. Largest random component of a  $k$ -cube. *Combinatorica*, **2**:1–7, (1982).
- [2] B. Bollobás. *Random Graphs*. Cambridge University Press, Cambridge, 2nd edition, (2001).
- [3] B. Bollobás, Y. Kohayakawa, and T. Łuczak. The evolution of random subgraphs of the cube. *Random Struct. Alg.*, **3**:55–90, (1992).
- [4] C. Borgs, J.T. Chayes, R. van der Hofstad, G. Slade, and J. Spencer. Random subgraphs of finite graphs: I. The scaling window under the triangle condition. Preprint, (2003). Available at <http://www.math.ubc.ca/~slade>.
- [5] C. Borgs, J.T. Chayes, R. van der Hofstad, G. Slade, and J. Spencer. Random subgraphs of finite graphs: II. The lace expansion and the triangle condition. Preprint, (2003). Available at <http://www.math.ubc.ca/~slade>.
- [6] C. Borgs, J.T. Chayes, R. van der Hofstad, G. Slade, and J. Spencer. Random subgraphs of finite graphs: III. The phase transition for the  $n$ -cube. Preprint, (2003). Available at <http://www.math.ubc.ca/~slade>.
- [7] P. Erdős and A. Rényi. On the evolution of random graphs. *Magyar Tud. Akad. Mat. Kutató Int. Közl.*, **5**:17–61, (1960).
- [8] M.E. Fisher and R.R.P. Singh. Critical points, large-dimensionality expansions, and the Ising spin glass. In G.R. Grimmett and D.J.A. Welsh, editors, *Disorder in Physical Systems*. Clarendon Press, Oxford, (1990).
- [9] R. van der Hofstad and G. Slade. Expansion in  $n^{-1}$  for percolation critical values on the  $n$ -cube and  $\mathbb{Z}^n$ : the first three terms. Preprint, (2003). Available at <http://www.math.ubc.ca/~slade>.
- [10] R. van der Hofstad and G. Slade. Asymptotic expansions in  $n^{-1}$  for percolation critical values on the  $n$ -cube and  $\mathbb{Z}^n$ . Preprint, (2003). Available at <http://www.math.ubc.ca/~slade>.

- [11] S. Janson, T. Łuczak, and A. Ruciński. *Random Graphs*. John Wiley and Sons, New York, (2000).

DEPARTMENT OF MATHEMATICS, UNIVERSITY OF BRITISH COLUMBIA, VANCOUVER, BC, CANADA V6R 2M6  
*E-mail address:* `slade@math.ubc.ca`

## PART 2

Presentations  
Présentations



## Utilizing Relationships Among Linear Systems Generated by Zeilberger's Algorithm

S. A. Abramov and H. Q. Le

**Abstract.** *We show that the sequence of first order linear difference equations generated by Zeilberger's algorithm can be described recursively. Each of these difference equations induces a system of linear algebraic equations and the mentioned recurrent relations can be utilized so that the values computed during the investigation of the  $J$ -th system can be used to accelerate the investigation of the  $(J+1)$ -th system. An implementation of this result and an experimental comparison between this implementation and an implementation of the original Zeilberger's algorithm are also done.*

**Résumé.** *Nous montrons que la suite des équations linéaires aux différences du premier ordre produites par l'algorithme de Zeilberger peut être décrite de façon récursive. Chacune de ces équations aux différences induit un système d'équations linéaires algébriques et lesdites relations de récurrence peuvent être employées de façon à ce que les valeurs calculées pendant l'analyse du  $J$ -ème système puissent être utilisées pour accélérer l'analyse du  $(J+1)$ -ème système. Nous faisons aussi une implantation de ce résultat et une comparaison avec l'implantation originale de l'algorithme de Zeilberger.*

### 1. Introduction

Zeilberger's algorithm, named hereafter as  $\mathcal{Z}$ , has been shown to be a very useful tool in a wide range of applications. These include finding closed forms of definite sums of hypergeometric terms, certifying large classes of identities in combinatorics and in the theory of special functions [Z91, PWZ].

For a hypergeometric term (or simply a *term*)  $F(n, k)$ ,  $\mathcal{Z}$  tries to find

$$(1.1) \quad A_0(n), \dots, A_J(n) \in \mathbb{K}(n), \quad A_J(n) \neq 0,$$

and a term  $S(n, k)$  such that

$$(1.2) \quad A_J(n)F(n+J, k) + \dots + A_0(n)F(n, k) = S(n, k+1) - S(n, k).$$

The algorithm uses an item-by-item examination on the values of  $J$ . It starts with the value of 0 for  $J$ , and keeps on incrementing  $J$  until it is successful in finding the  $A_0, \dots, A_J$  and  $S(n, k)$  such that (1.2) holds. For a particular value of  $J$  under investigation,  $\mathcal{Z}$  constructs a system of linear algebraic equations whose coefficients are in  $\mathbb{K}(n)$ , and its right hand side linearly depends on parameters  $A_0, \dots, A_J$ . It then checks for the existence of (1.1) such that the linear system is consistent (see [Z91, PWZ] for details). This operation is expensive if the value of  $J$  is large.

---

1991 *Mathematics Subject Classification.* Primary 68W30, 33F10.

*Key words and phrases.* Zeilberger's algorithm, hypergeometric term, linear systems.

The first author was supported in part by the French-Russian Lyapunov Institute under grant 98-03.

While the problem of applicability of  $\mathcal{Z}$  to a term has been completely solved [A03], the issue of efficiency is still an on-going work. For the case where the input term is also a rational function, there is a direct algorithm [L03] which avoids the item-by-item examination strategy. For the non-rational hypergeometric case, even though there is an algorithm which computes a non-trivial lower bound  $J_0$  for  $J$  [AL02],  $\mathcal{Z}$  still wastes resource on the fruitless examination at steps  $J_0, J_0 + 1, \dots, J - 1$ .

The examination done at each step is independent of that at other steps. However, there are relationships between two consecutive steps, and it would be logical to try to utilize them. It is shown in this paper that after we considered the system corresponding to step  $J$  and found that it is not consistent, we can use some intermediate results of this step in order to either reduce the size of the linear system at step  $(J+1)$  or simplify this system. In this context, “simplify” means the elimination of the parameters  $A_0, \dots, A_J$  in a number of equations of the  $(J+1)$ -th system.

Throughout the paper,  $\mathbb{K}$  is a field of characteristic zero,  $\mathbb{N}$  is the set of nonnegative integers.  $E_n, E_k$  denote the shift operators w.r.t.  $n$  and  $k$ , respectively, defined by  $E_n F(n, k) = F(n + 1, k)$ ,  $E_k F(n, k) = F(n, k + 1)$ .

The basic idea of this work was presented in our poster at FPSAC 2003 [AL03]. In this paper, this idea is further extended. The derivation of the relationships between two consecutive steps is significantly simplified. A complete Maple implementation and an extensive experimental comparison with an implementation of the original Zeilberger’s algorithm are added.

The Maple source code, the help page, and the test results reported in this paper are available, and can be downloaded from

<http://www.scg.uwaterloo.ca/~hqle/code/Linsys/Linsys.html>.

## 2. Step-by-step examination in $\mathcal{Z}$

**2.1. Reduction to a linear algebra problem.** For a term  $F(n, k)$  and for a particular value of  $J \in \mathbb{N}$ , set

$$(2.1) \quad T_J(n, k) = A_J(n)F(n + J, k) + \dots + A_1(n)F(n + 1, k) + A_0(n)F(n, k).$$

$\mathcal{Z}$  attempts to compute the  $A_i$ ’s  $\in \mathbb{K}(n)$  in (2.1) and a term  $S$  such that (1.2) holds. Since  $F$  is a term,  $T_J$  is also a term [Z91]. This allows  $\mathcal{Z}$  to use Gosper’s algorithm [G77] to attain its goal. Given the term  $T_J$  in (2.1), Gosper’s algorithm determines if there exists a term  $S_J$  such that

$$(2.2) \quad T_J = (E_k - 1)S_J,$$

and computes  $S_J$  if it exists. The algorithm transforms (2.2) into the problem of computing a polynomial solution of a first-order linear recurrence equation with polynomial coefficients and polynomial right hand side (2.4). The process can be summarized as follows.

- (1) Compute a PNF $_k$  (also known as Gosper form) of the rational  $k$ -certificate  $T_J(n, k + 1)/T_J(n, k)$ . This results in a triple  $(a_J, b_J, c_J)$ ,  $a_J, b_J, c_J \in \mathbb{K}(n)[k] \setminus \{0\}$  such that

$$(2.3) \quad \frac{T_J(n, k + 1)}{T_J(n, k)} = \frac{a_J}{b_J} \cdot \frac{E_k c_J}{c_J}, \quad \gcd(a_J, E_k^h b_J) = 1 \text{ for all } h \in \mathbb{N}.$$

See [PWZ] for a description of such a construction.

- (2) Find a polynomial solution  $y(k)$  of the linear recurrence

$$(2.4) \quad a_J(k)y(k + 1) - b_J(k - 1)y(k) = c_J(k)$$

provided that such a solution exists.

If it does, then set

$$(2.5) \quad L_J = A_J(n) E_n^J + \cdots + A_1(n) E_n + A_0(n),$$

$$(2.6) \quad S_J = \frac{b_J(k-1)y(k)}{c_J(k)} T_J.$$

The computed  $Z$ -pair  $(L_J, S_J)$  defined in (2.5) and (2.6) is the output from  $\mathcal{Z}$ . The recurrence operator  $L_J$  is called a telescoper for the input term  $F$ .

The search for a polynomial solution  $y(k)$  of (2.4) can be done using the method of undetermined coefficients. First one computes an upper bound  $d$  for the degree of the polynomial  $y(k)$ . Then one substitutes a generic polynomial of degree  $d$  for  $y(k)$  into (2.4), equates the coefficients of like powers in  $k$ . This results in a system of linear algebraic equations. The problem is reduced to determining if this linear system is consistent. If it is, then compute a solution of the system. Note that this enables one to compute not only a polynomial solution  $y(k)$  in (2.4), but also the unknowns  $A_i$ 's in (2.1).

**2.2. Simplificators and the  $J$ -increment of a system.** The system of linear algebraic equations at step  $J$  is of the form

$$(2.7) \quad M_J x_J = u_J$$

where  $M_J$  is a  $\nu \times \kappa$  matrix whose entries are in the field  $\mathbb{K}(n)$ , and  $u_J$  is a column vector where each of its  $\nu$  entries is in the  $\mathbb{K}(n)$ -linear space  $U$  and of the form

$$(2.8) \quad R_0 A_0 + \cdots + R_J A_J, \quad R_0, \dots, R_J \in \mathbb{K}(n).$$

We call the system (2.7) a  $J$ -parameterized system. If it is consistent, then the system is said to be  $J$ -solvable.

The following definition provides important concepts used in this paper.

**Definition 2.1.** For a  $J$ -parameterized system  $S$  of the form (2.7), a column vector  $y_J \in U^\kappa$  is a *simplificator* of  $S$  if the first entry of  $u_J - M_J y_J$  is zero. The *height* of  $y_J$  is the number of all initial entries of  $u_J - M_J y_J$  each of which equals zero. The  *$J$ -increment* of  $S$  is the number of all initial entries of  $u_J$  which do not depend on  $A_0, \dots, A_{J-1}$ .

Suppose the recognition of the  $J$ -solvability of system (2.7) is done by an elimination process. During this process we can get an equation of the form

$$(2.9) \quad 0 = \tilde{R}_0 A_0 + \tilde{R}_1 A_1 + \cdots + \tilde{R}_{J-1} A_{J-1} + \tilde{R}_J A_J, \quad \tilde{R}_i \in \mathbb{K}(n).$$

Such an equation is called *trivial* if  $\tilde{R}_0 = \cdots = \tilde{R}_J = 0$ ; *irregular* if  $(\tilde{R}_0 = \cdots = \tilde{R}_{J-1} = 0$  and  $\tilde{R}_J \neq 0)$  or if  $(\tilde{R}_1 = \cdots = \tilde{R}_J = 0$  and  $\tilde{R}_0 \neq 0)$ ; and *regular* otherwise. The existence of an irregular equation implies that the system is not  $J$ -solvable.

Although the equations might change their orderings during the elimination process, we assign to each equation a label which is the number of this equation in the original system, and hence are still able to keep track of its position. The process results in two systems  $W$  and  $V$ :  $W$  is a trapezoidal system of regular equations; and the equations of  $V$  are those obtained during the elimination process, but not of the form (2.9).

If  $W$  is consistent with  $A_J \neq 0$ ,  $A_0 \neq 0$ , then the original system is  $J$ -solvable. Otherwise, it is not  $J$ -solvable, and we can construct a simplificator of the system as follows.

- (i) Find the maximal  $N$  such that equations labeled  $1, \dots, N$  are in  $V$ ;
- (ii) For all  $i = 1, \dots, N$ , the unknown  $x_i$  was eliminated by an equation with label  $j$ ,  $1 \leq j \leq N$ .

This results in a system  $V'$ , a subsystem of  $V$  and consisting of equations labeled  $1, \dots, N$ . The vector  $(x_1, \dots, x_N, 0, \dots, 0)^T$  is evidently a simplificator of height  $\geq N$  of the original system.

### 3. A simplification scheme

**3.1. Relationships among  $J$ -parameterized systems.** Let  $F(n, k)$  be the input term. At step  $J$  of the item-by-item examination,  $\mathcal{Z}$  tries to compute a telescoper  $L_J$  of the form (2.5) for  $F$ . The  $k$ -certificate  $(E_k T_J)/T_J$  of the term  $T_J(n, k) = L_J F$  can be written in the form

$$(3.1) \quad \frac{v_J(n, k)}{w_J(n, k)} = \frac{\varphi_J(n, k)}{\psi_J(n, k)} \frac{p_J(A_0, \dots, A_J, n, k+1)}{p_J(A_0, \dots, A_J, n, k)}$$

where  $v_J, w_J \in \mathbb{K}[n, k]$ ;  $\varphi_J(n, k), \psi_J(n, k) \in \mathbb{K}[n, k]$  and do not depend on  $A_0, \dots, A_J$ ;  $p_J$  is in the  $\mathbb{K}(n, k)$ -space of linear forms in  $A_0, \dots, A_J$ .

Let  $s_1(n, k), s_2(n, k)$  be relatively prime polynomials such that

$$\frac{F(n, k)}{F(n-1, k)} = \frac{s_1(n, k)}{s_2(n, k)}.$$

Then we can derive the following recurrences:

$$(3.2) \quad \begin{aligned} p_{J+1}(A_0, \dots, A_{J+1}, n, k) &= p_J(A_0, \dots, A_J, n, k) s_2(n+J+1, k) + \\ &A_{J+1} \prod_{i=1}^{J+1} s_1(n+i, k), \end{aligned}$$

$$(3.3) \quad \varphi_{J+1}(n, k) = \varphi_J(n, k) s_2(n+J+1, k),$$

$$(3.4) \quad \psi_{J+1}(n, k) = \psi_J(n, k) s_2(n+J+1, k+1).$$

(They are similar to (6.3.6)–(6.3.8) in [PWZ].) Let

$$(3.5) \quad \text{PNF}_k \left( \frac{\varphi_J}{\psi_J} \right) = \frac{a_J(k)}{b_J(k)} \frac{\xi_J(k+1)}{\xi_J(k)}.$$

It follows from (3.3), (3.4) and (3.5) that

$$(3.6) \quad a_J(k) = a_0(k) \frac{s_2(n+J, k) \cdots s_2(n+1, k)}{s_2(n+J, k+1) \cdots s_2(n+1, k+1)} \frac{\xi_0(k+1)}{\xi_0(k)} \frac{\xi_J(k)}{\xi_J(k+1)} \frac{b_J(k)}{b_0(k)}.$$

Let  $a, b$  be polynomials in  $k$ . Define

$$(3.7) \quad G_{a(k), b(k)} = a(k)E_k - b(k-1).$$

By (3.6) and (3.7), we obtain the following theorem which shows the relationships between  $G_{a_J(k), b_J(k)}$  and  $G_{a_{J+1}(k), b_{J+1}(k)}$ .

**Theorem 3.1.** *The operators  $G_{a_J(k), b_J(k)}$  and  $G_{a_{J+1}(k), b_{J+1}(k)}$  for  $J \in \mathbb{N}$  are related by the following recurrence:*

$$(3.8) \quad G_{a_J(k), b_J(k)} = \frac{\xi_J(k)}{s_2(n+J+1, k) \xi_{J+1}(k)} G_{a_{J+1}(k), b_{J+1}(k)} \circ \frac{s_2(n+J+1, k) \xi_{J+1}(k) b_J(k-1)}{\xi_J(k) b_{J+1}(k-1)}.$$

**3.2. Polynomial simplification.** At step  $J$  of the item-by-item examination, it follows from (2.4) and (3.7) that the recurrence

$$(3.9) \quad G_{a_J(k), b_J(k)} y(k) = c_J(k)$$

where  $c_J(k) = \xi_J(k) p_J(k)$ ,  $J \in \mathbb{N}$ , is considered. By (3.2)

$$(3.10) \quad c_{J+1}(k) = \frac{\xi_{J+1}(k)}{\xi_J(k)} s_2(n+J+1, k) c_J(k) + \xi_{J+1}(k) A_{J+1} \prod_{i=1}^{J+1} s_1(n+i, k).$$



If the right hand side  $c_J(k)$  of the  $J$ -th recurrence (3.9) is simplified by means of a polynomial  $f_J(k)$ , then it gets transformed to  $c'_J(k)$  where

$$(3.11) \quad c'_J(k) = c_J(k) - G_{a_J(k), b_J(k)} f_J(k), \quad \deg_k c_J > \deg_k c'_J.$$

It follows from (3.2), (3.8) and (3.11) that if we replace  $c_J(k)$  by  $c'_J(k)$  in the right hand side of (3.10), then the first term  $\frac{\xi_{J+1}(k)}{\xi_J(k)} s_2(n+J+1, k) c'_J(k)$  of this right hand side equals

$$\xi_{J+1}(k) s_2(n+J+1, k) p_J(k) - G_{a_{J+1}, b_{J+1}} \frac{s_2(n+J+1, k) \xi_{J+1}(k) b_J(k-1)}{\xi_J(k) b_{J+1}(k-1)} f_J(k).$$

This induces the change of  $c_{J+1}(k)$  by  $\tilde{c}_{J+1}(k)$  where

$$(3.12) \quad \tilde{c}_{J+1}(k) = c_{J+1}(k) - G_{a_{J+1}, b_{J+1}} \frac{s_2(n+J+1, k) \xi_{J+1}(k) b_J(k-1)}{\xi_J(k) b_{J+1}(k-1)} f_J(k).$$

Once a polynomial  $g_{J+1}(k)$  is found such that for

$$c'_{J+1}(k) = \tilde{c}_{J+1}(k) - G_{a_{J+1}, b_{J+1}} g_{J+1}(k),$$

we have  $\deg_k c'_{J+1} < \deg_k c_{J+1}$ . Then the right hand side  $c_{J+1}(k)$  of the  $(J+1)$ -th recurrence  $G_{a_{J+1}(k), b_{J+1}(k)} y(k) = c_{J+1}(k)$  will be simplified by means of the polynomial  $f_{J+1}(k)$  where

$$f_{J+1}(k) = \frac{s_2(n+J+1, k) \xi_{J+1}(k) b_J(k-1)}{\xi_J(k) b_{J+1}(k-1)} f_J(k) + g_{J+1}(k).$$

Let  $\deg_k c_J - \deg_k c'_J = H_J > 0$ . Let the two terms in the right hand side of (3.10) be  $R$  and  $S$ , i.e.,

$$R = \frac{\xi_{J+1}(k)}{\xi_J(k)} s_2(n+J+1, k) c_J(k), \quad S = \xi_{J+1}(k) A_{J+1} \prod_{i=1}^{J+1} s_1(n+i, k).$$

Note that  $S$  is independent of  $A_0, \dots, A_J$ . By comparing the degrees of  $R$  and  $S$  in (3.10), we obtain the following theorem which reflects changes to the  $(J+1)$ -system because of the replacement of  $c_J$  by  $c'_J$ .

**Theorem 3.2.** *Suppose it is recognized that the  $J$ -system of the form (2.7) is not  $J$ -solvable, and that a simplifier  $y_J(k)$  of height  $H_J > 0$  for this system is computed.*

- (1)  $\deg_k S > \deg_k R$ : let  $\sigma_J, \sigma_{J+1}$  be the  $J$ -increment of the  $J$ -system, and the  $(J+1)$ -increment of the  $(J+1)$ -system, respectively. Then

$$\sigma_{J+1} = \deg_k S - \deg_k R + \max\{H_J, \sigma_J\},$$

*i.e., if  $H_J > \sigma_J$  then the  $(J+1)$ -increment of the  $(J+1)$ -system is increased, and we have a simpler  $(J+1)$ -system;*

- (2)  $\deg_k S \leq \deg_k R$ : the degree of  $c_{J+1}$  w.r.t.  $k$  is decreased by  $\min\{H_J, \deg_k R - \deg_k S\}$ . This leads to a system of linear algebraic equations of smaller size to be solved.

#### 4. Implementation

We implemented the result of this paper in the computer algebra system Maple [M], and performed experiments of our program (called  $M$ ) on four different sets of data. A comparison between this implementation and the one of the original  $\mathcal{Z}$  (called  $Z$ ) in Maple 9 (the function `Zeilberger` in the `SumTools:-Hypergeometric` module) was also done. Note that the development of  $M$  is based on  $Z$ .

The result shows that it is worthwhile incorporating the simplification scheme presented in this paper into  $\mathcal{Z}$ .

**Experiment 4.1.** The first set of input consists of seven hypergeometric terms

$$T_i(n, k) = \binom{2n}{2k}^i, \quad 2 \leq i \leq 8.$$

Table 1 shows the time and space requirements<sup>1</sup>.  $\text{ord } L_i$  indicates the order of the computed minimal telescoper  $L_i$  of the input term  $T_i$ .

TABLE 1. First experiment: time and space requirements of  $Z$  and  $M$

$i$	$\text{ord } L_i$	Timing (seconds)		Memory (kilobytes)	
		$Z$	$M$	$Z$	$M$
2	2	0.54	0.54	2,977	2,959
3	3	3.57	2.81	18,168	15,335
4	4	31.24	23.35	179,221	132,859
5	5	199.40	142.13	1,021,542	762,488
6	6	1,523.86	1,242.03	6,429,441	4,902,558
7	7	8,563.81	6,205.83	28,326,178	18,530,142
8	8	42,122.52	36,917.47	92,161,603	66,414,167
Total time		52,444.94	44,534.16		

Each input term in the following three sets of data is an  $r$ -term [A03]. Since every hypergeometric term is conjugate to an  $r$ -term, i.e., they share the same rational certificates, and since  $\mathcal{Z}$  in principal only works with the certificates of the input term, the sets of data we use can be considered to cover all possible forms of input hypergeometric terms.

**Experiment 4.2.** The second set of tests consists of twenty randomly-generated hypergeometric terms each of which is of the form

$$T_i(n, k) = \frac{1}{(a_i n + b_i k + c_i)!}, \quad -15 \leq a_i, b_i, c_i \leq 15, \quad |b_i| \geq 6.$$

Table 2 shows the time and space requirements.

**Experiment 4.3.** The third set of tests consists of twenty randomly-generated hypergeometric terms each of which is of the form

$$T_i(n, k) = \frac{(a_{i1}n + b_{i1}k + c_{i1}) (a_{i2}n + b_{i2}k + c_{i2})!}{(a_{i3}n + b_{i3}k + c_{i3}) (a_{i4}n + b_{i4}k + c_{i4})!}$$

where  $-5 \leq a_{ij}, b_{ij}, c_{ij} \leq 5, 1 \leq j \leq 4$ . Table 3 shows the time and space requirements.

**Experiment 4.4.** The fourth set of tests consists of twenty randomly-generated hypergeometric terms each of which is of the form

$$T_i(n, k) = \frac{(a_{i1}n + b_{i1}k + c_{i1})! (a_{i2}n + b_{i2}k + c_{i2})!}{(a_{i3}n + b_{i3}k + c_{i3})! (a_{i4}n + b_{i4}k + c_{i4})!}$$

where  $-6 \leq a_{ij}, b_{ij}, c_{ij} \leq 6, 1 \leq j \leq 4$ . Table 4 shows the time and space requirements.

## References

- [A03] S.A. Abramov. When does Zeilberger's algorithm succeed? *Advances in Applied Mathematics* **30** (2003) 424–441.  
 [AL03] S.A. Abramov, H.Q. Le. The sequence of linear algebraic systems generated by Zeilberger's algorithm. *Proceedings of the 2003 Formal Power Series and Algebraic Combinatorics*, on CD (Poster session).  
 [AL02] S.A. Abramov, H.Q. Le. A lower bound for the order of telescopers for a hypergeometric term. *Proceedings of the 2002 Formal Power Series and Algebraic Combinatorics*, on CD.

<sup>1</sup>All the reported timings were obtained on a 400Mhz SUN SPARC SOLARIS with 1Gb RAM.

TABLE 2. Second experiment: time and space requirements of  $Z$  and  $M$ 

$i$	ord $L_i$	Timing (seconds)		Memory (kilobytes)	
		$Z$	$M$	$Z$	$M$
1	3	1.05	0.72	5,722	4,176
2	5	19.43	19.58	98,068	105,292
3	6	116.98	91.04	561,628	552,879
4	8	196.16	118.29	787,282	675,806
5	3	7.58	7.02	54,561	53,492
6	6	15.23	14.45	79,553	70,003
7	8	34.68	16.30	173,941	105,203
8	3	1.99	1.46	10,592	9,270
9	10	3,163.60	1,369.30	7,799,715	5,418,995
10	6	79.05	65.70	342,584	287,447
11	15	14,558.05	4,568.70	23,774,518	14,933,116
12	13	4,503.45	3,226.63	10,566,736	10,922,477
13	7	29.58	31.93	170,337	177,498
14	5	166.36	155.62	693,555	761,711
15	7	5.90	5.38	29,689	27,090
16	11	2,456.17	1,402.33	6,576,152	5,966,455
17	3	17.33	15.53	92,278	101,312
18	3	3.04	4.16	30,133	32,015
19	13	133.53	95.87	640,949	536,200
20	3	10.79	10.66	61,675	56,596
Total time		25,519.95	11,220.67		

[G77] R.W. Gosper, Jr. Decision procedure for indefinite hypergeometric summation. *Proc. Natl. Acad. Sci. USA* **75** (1977) 40–42.

[L03] H.Q. Le. A direct algorithm to construct the minimal  $Z$ -pairs for rational functions. *Advances in Applied Mathematics* **30** (2003) 137–159.

[M] M.B. Monagan, K.O. Geddes, K.M. Heal, G. Labahn, S.M. Vorkoetter, J. McCarron, P. DeMarco. *Maple 9 Introductory Programming Guide*. Toronto: Maplesoft, a division of Waterloo Maple Inc., 2003.

[PWZ] M. Petkovšek, H. Wilf, D. Zeilberger. *A=B*. A.K. Peters, Wellesley, Massachusetts, 1996.

[Z91] D. Zeilberger. The method of creative telescoping. *Journal of Symbolic Computation* **11** (1991) 195–204.

DORODNICYN COMPUTING CENTRE, RUSSIAN ACADEMY OF SCIENCES, VAVILOVA 40, 119991, MOSCOW, GSP-1, RUSSIA  
*E-mail address:* `abramov@ccas.ru`

ALGORITHMS PROJECT, INRIA ROCQUENCOURT, 78153 LE CHESNAY CEDEX, FRANCE  
*E-mail address:* `ha.le@inria.fr`

TABLE 3. Third experiment: time and space requirements of  $Z$  and  $M$ 

$i$	ord $L_i$	Timing (seconds)		Memory (kilobytes)	
		$Z$	$M$	$Z$	$M$
1	7	251.94	213.26	1,149,488	1,105,805
2	6	362.69	259.91	1,744,877	1,258,468
3	2	0.89	0.78	4,529	4,184
4	6	41.57	31.33	214,770	180,945
5	4	21.26	13.89	106,702	72,569
6	8	261.54	185.26	1,426,237	902,509
7	6	87.39	49.76	449,139	285,798
8	5	98.97	63.83	527,146	308,765
9	9	740.47	708.66	3,580,681	3,488,491
10	5	5.36	4.39	24,382	22,782
11	2	0.70	0.58	3,661	3,380
12	5	61.74	48.81	301,470	251,228
13	4	14.08	11.54	76,225	67,605
14	8	1,191.93	1,098.12	5,615,755	5,450,072
15	8	2,424.06	2,157.03	9,813,850	9,280,051
16	8	1,470.97	1,185.56	7,071,945	5,827,483
17	7	1.60	1.51	7,987	7,864
18	1	0.71	0.52	3,966	3,093
19	6	180.37	145.82	778,584	673,263
20	5	7.88	7.74	43,221	39,400
Total time		7,226.12	6,188.30		

TABLE 4. Fourth experiment: time and space requirements of  $Z$  and  $M$ 

$i$	ord $L_i$	Timing (seconds)		Memory (kilobytes)	
		$Z$	$M$	$Z$	$M$
1	9	17.19	10.80	89,010	66,383
2	8	529.95	433.59	2,434,037	1,954,207
3	7	74.33	46.76	453,495	301,637
4	8	323.57	258.28	1,354,762	1,200,625
5	6	184.65	135.11	996,090	786,864
6	9	2,934.08	1,221.24	14,901,781	5,977,105
7	7	223.33	190.57	1,081,266	910,766
8	9	9,338.72	7,982.59	31,056,490	28,264,207
9	6	52.94	37.09	239,317	164,542
10	7	308.47	236.07	1,506,582	1,171,261
11	7	2,070.33	709.82	10,329,829	3,364,322
12	4	14.13	11.44	79,847	62,823
13	9	1,865.57	1,712.06	9,582,506	8,528,627
14	7	50.60	40.76	269,926	216,128
15	7	171.14	138.65	823,582	674,723
16	6	39.51	30.28	211,825	175,698
17	8	943.22	690.12	5,363,613	3,628,208
18	5	89.86	59.02	446,246	307,635
19	11	17,514.39	16,398.59	63,496,067	58,960,912
20	6	133.81	88.30	643,233	473,633
Total time		36,879.79	30,431.14		





## Bounds For The Growth Rate Of Meander Numbers

M. H. Albert and M. S. Paterson

**Abstract.** *We provide improvements on the best currently known upper and lower bounds for the exponential growth rate of meanders. The method of proof for the upper bounds is to extend the Goulden-Jackson cluster method.*

### Limites au taux de croissance des nombres de méandres

**Résumé.** *Nous fournissons des améliorations aux meilleures bornes supérieures et inférieures actuellement connues pour le taux de croissance exponentiel des méandres. La méthode de preuve des bornes supérieures nécessite une extension de la méthode des “grappes” due à Goulden et Jackson.*

### 1. Introduction

A *meander* of order  $n$  is a self-avoiding closed curve crossing a given line in the plane at  $2n$  places, [LZ93]. Two meanders are equivalent if one can be transformed into the other by smooth deformations of the plane, which leave the line fixed (as a set). A number of authors have addressed the problem of exact and asymptotic enumeration of the number  $M_n$  of meanders of order  $n$  (see for instance [FE02, Jen00] and references therein). It is widely believed that an asymptotic formula

$$M_n \approx CM^n n^\alpha$$

applies, and some effort has been devoted to estimating the parameters  $M$  and  $\alpha$  ([DF00, DFGG00, DFGJ00, JG00]). Broadly, these methods have relied on extrapolation from exact values of  $M_n$ , currently known for  $n \leq 24$  (see [JG00]). A careful estimate, using differential approximants based on these values, yields [JG00] the approximate value

$$M \simeq 12.26287.$$

A presumed correspondence with certain field theories has yielded the amazing conjecture [DFGG00] that:

$$\alpha = \sqrt{29}(\sqrt{29} + \sqrt{5})/12 = 3.42013288 \dots$$

Our, less ambitious, aim will be to provide rigorous upper and lower bounds on the exponential growth rate of  $M_n$ .

Consider the generating function:

$$M(t) = \sum_{n=0}^{\infty} M_n t^{2n}.$$

It is easy to verify that  $M_{a+b} \geq M_a M_b$  and so it is certainly the case that  $M := \lim_{n \rightarrow \infty} M_n^{1/n}$  exists, and is the square of the reciprocal of the radius of convergence of this series. We will prove:

---

1991 *Mathematics Subject Classification.* Primary 05A15, 05A16; Secondary 57M99, 82B41.  
*Key words and phrases.* meander, cluster method.

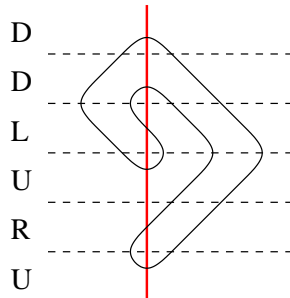
FIGURE 1. The meander  $URULLDD$ .

**Theorem 1.1.** *The following inequalities hold:*

$$11.380 \leq M \leq 12.901.$$

These bounds improve (on both sides) the best previous bounds due to Richard Stanley ( $M > 10.0$ ) [1995, private communication] and Jim Reeds and Larry Shepp ( $M \leq 13.002$ ) [1999, unpublished].

Our basic methodology is to represent meanders as a language over an alphabet consisting of four symbols. The bounds are then obtained by producing suitable sublanguages and superlanguages for which the growth rates can be computed explicitly. In principle our bounds could be improved by more detailed construction of these languages, and we include some indication in the final section of how much further progress might be possible by such means.

## 2. Definitions and notation

We begin by providing a combinatorial description of meanders which allows us to identify them with a language over a four letter alphabet. This interpretation is similar to the description of meanders by means of “configurations” in [Jen00].

Set the orientation of the line which the meander crosses as vertical. We allow a meander to evolve as we move upwards along the line. Each step in this evolution is marked by a place where the meander crosses the line, and we allow these crossings to be of four types:  $U$  where a new segment of the meander is created,  $D$  where two previous segments are merged into one (or as a final step the meander is completed), and  $R$  or  $L$  where a segment crosses the line from left to right, or right to left respectively. Figure 1 illustrates this encoding of meanders.

The *meander language*,  $\mathcal{M}$ , is the set of words in these four letters that represent meanders. It is immediately clear that distinct words in the meander language represent distinct meanders, and only slightly less clear that every meander is represented by a single word in the meander language.

We digress briefly to recapitulate some standard notation and terminology concerning words and languages. A *word* is simply a finite sequence of symbols from some alphabet  $\Sigma$ . This sequence may be empty, and the empty word is denoted  $\epsilon$ . The set of all words over  $\Sigma$  is denoted  $\Sigma^*$  and can be identified with the free monoid over  $\Sigma$  by considering juxtaposition as the monoid operation. So, a word  $v$  is said to be a *factor* of a word  $w$  if  $w = xvy$  for some words  $x$  and  $y$ . If we can take  $x = \epsilon$  then we say that  $v$  is a *prefix* of  $w$  while if we can take  $y = \epsilon$  then we say that  $v$  is a *suffix* of  $w$ . A *language* over  $\Sigma$  is simply a subset of  $\Sigma^*$ . The  $()^*$  notation is extended to languages, or even words, so that  $X^*$  simply means the language which consists of all possible juxtapositions (including the empty one) of elements of  $X$ . The length of a word  $w$ , that is, the number of symbols in the sequence  $w$ , is denoted  $|w|$ . Hence  $M_n$ , the number of meanders with  $2n$  crossings is simply the number of words in  $\mathcal{M}$  of length  $2n$  (since each symbol in a meander word accounts for a single crossing).

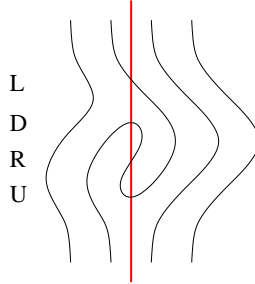

FIGURE 2.  $URDL$  has no effect on the environment

In our interpretation of meanders it makes sense to speak of the environment that exists as we scan prefixes of a word. This environment is simply the collection of segments in their appropriate order on either side of the line. Further, we adopt the convention that when two segments are merged, the newly merged segment is identified in the environment with the older of the two (in a meander the only time we will merge two segments of the same age is at the final  $D$ ).

Sometimes it is useful to imagine that we have available an extended environment consisting initially of an infinite family of labelled and completely unmatched segments on either side of the line. This allows the effect of any word to be interpreted within this environment. For our purposes, words whose only effect is to shift some segments from one side of the line to the other are particularly significant. In Figure 2 we illustrate how the factor  $URDL$  has no effect on the surrounding environment. In particular this means that if  $w = uv$  is a meander, and if the environment following  $u$  contains a segment to the left of the line, then  $uURDLv$  is also a meander. On the other hand, it is also clear that no meander (aside from  $UD$ ) can have  $UD$  as a factor, and so neither can it have  $UURDLLD$  as a factor. From observations of the former kind we obtain sublanguages of  $\mathcal{M}$  by building up words which must be meanders. From observations of the latter kind we obtain superlanguages of  $\mathcal{M}$  by requiring words to avoid certain factors.

Throughout the remaining sections we identify languages over  $U, D, R, L$  with their generating function in the power series ring over  $U, D, R, L$ . Generally we work in this context to obtain relationships between (the generating functions of) various languages, and then specialize to a single variable  $t$  when we wish to obtain numerical estimates.

### 3. Shifts and lower bounds

Consider a state of the extended meander environment, such as might be achieved after executing some prefix  $p$  of a meander word. There are now various continuations which will have the same effect *on the environment* as  $R^k$  would for some  $k$ . Trivially any sequence of  $R$ 's and  $L$ 's which has  $k$  more  $R$ 's than  $L$ 's is such a continuation. However, it is also the case that  $URD$  has the same effect on the environment as  $R$ , and  $UURRDD$  has the same effect as  $RR$ . Furthermore these constructions can be recursively combined and therefore:

$$U(UURRDD)LD$$

has the same effect as  $URRLD$ , hence as  $URD$  and finally as  $R$ .

**Definition 3.1.** A *shift* is a word whose effect on the extended meander environment is the same as that of  $R^k$  or  $L^k$  for some non-negative integer  $k$ . The *displacement* of a shift is  $k$  in the former case, and  $-k$  in the latter. A *jump* is a shift having no proper shift prefix<sup>1</sup>. A shift whose only proper shift factors are in  $R^*$  or  $L^*$  is called *primitive*.

<sup>1</sup>We apologize to the sensitive reader for using “shift” both as a noun and an adjective

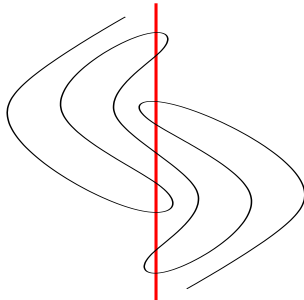
FIGURE 3.  $URUL^3DRD$  is a jump of displacement  $-1$ .

The simplest jumps are  $R$  and  $L$ . Next simplest are  $URD$  and  $ULD$ . A rather more complicated example is shown in Figure 3.

Every shift can be uniquely factored as a concatenation of jumps. In turn, every jump is created from some (uniquely determined) primitive shift by substitution of shifts for the blocks of  $R$ 's and  $L$ 's within the primitive shift. For example  $UUURRDDLD$  is created from  $URD$  by substituting  $UUURRDD$  ( $L$  a shift of displacement 1 formed from a jump of displacement 2, and one of displacement  $-1$ ) for  $R$ .

If  $\mathcal{J}$  is the language of all jumps and  $\mathcal{S}$  the language of all shifts, then of course

$$(3.1) \quad \mathcal{S} = \mathcal{J}^* = \frac{1}{1 - \mathcal{J}}.$$

Introducing a new indexing variable  $x$  which commutes with the symbols of the language, and letting  $\mathcal{J}_i$  (or  $\mathcal{S}_i$ ) be the language of jumps (or shifts) of displacement  $i$ , we have slightly more generally that:

$$\sum_{i=-\infty}^{\infty} \mathcal{S}_i x^i = \frac{1}{1 - \sum_{i=-\infty}^{\infty} \mathcal{J}_i x^i}.$$

Suppose that  $J$  is some primitive jump. Then the set of all jumps with primitive form  $J$  is obtained by replacing each (possibly null) block of  $L$ 's or  $R$ 's between consecutive occurrences of  $U$  or  $D$  by  $\mathcal{S}_k$  where  $k$  is the displacement of the block. Denote the result of this replacement by  $J^{\mathcal{S}}$ . Then  $\mathcal{J}_i$  is the sum over primitive jumps  $J$  of displacement  $i$  of the terms  $J^{\mathcal{S}}$ .

Let  $s_i(t)$  be the generating function obtained from  $\mathcal{S}_i$  by replacing all of  $U$ ,  $D$ ,  $L$ , and  $R$  by  $t$ . Since

$$t^{2i} s_0 < t^i s_i < s_0$$

all of the functions  $s_i$  have the same radius of convergence.

**Proposition 3.2.** *The radius of convergence of  $s_0$  is not greater than that for the meander language.*

PROOF. The result follows from the observation that  $M(t) \leq t^2 s_0$ , since every meander is of the form  $USD$  where  $S$  is a shift of displacement 0.  $\square$

It seems clear that among all the shift words of length  $2n$  only a vanishingly small proportion contain a prefix with a difference of at least  $n^{3/4}$  between the numbers of  $R$ 's and  $L$ 's (here  $n^{3/4}$  is an arbitrary value – larger than  $\sqrt{n}$ , by correspondence with a 1-dimensional drunkard's walk). Any such shift could then be built into a meander of  $2n(1 + o(1))$  crossings. This would establish that the shift language and the meander language have the same radius of convergence. The proof of this result is too involved to present here, but will appear in the full paper.

For our immediate computational purposes though it is superfluous as our shifts will be built up recursively from a set of primitive shifts whose excursions to the left or the right are of bounded size. Since we

work with a symmetric (in  $R$  and  $L$ ) set of shifts, the argument above then applies correctly to this situation. This observation is explained further at the end of subsection 6.1.

#### 4. The cluster method

The *cluster method* is a method of enumerating words with a given finite set of forbidden factors. It was introduced in this form in [GJ79] and is also discussed in [GJ83]. Extensions of the cluster method are given in [NZ99] to handle certain cases where the forbidden set of factors is infinite. We need to supply a similar extension in an even more general setting.

Let  $\Sigma$  be an alphabet, and  $\mathcal{B}$  a subset of  $\Sigma^+$  (the non-empty words over  $\Sigma$ ). We are concerned with the language consisting of those words which have no factor from  $\mathcal{B}$ , the  *$\mathcal{B}$ -factor-free words*, that is the complement in  $\Sigma^*$  of  $\Sigma^*\mathcal{B}\Sigma^*$ . If  $b$  is a factor of  $c$  and  $b$  does not occur as a factor of some word  $w$ , then of course neither does  $c$ . So, for any  $\mathcal{B}$ , the  $\mathcal{B}$ -factor-free words are the same as the  $\mathcal{B}'$ -factor-free words, where  $\mathcal{B}'$  consists of the minimal elements of  $\mathcal{B}$  in the factor ordering. Therefore we assume throughout that no word  $b \in \mathcal{B}$  is a proper factor of any other word in  $\mathcal{B}$ .

Define the set of *overlaps*,  $Ov(\mathcal{B})$  to be the collection of all triples  $(b, w, c)$  such that  $b, c \in \mathcal{B}$ ,  $w \in \Sigma^+$ , such that  $b \neq c$  and for some  $b^l$  and  $c^r$ ,  $b = b^lw$  and  $c = wc^r$ . Note that, owing to the assumption above, neither  $b^l$  nor  $c^r$  can be the empty word. The system of equations:

$$(4.1) \quad v_b = b - \sum \{b^l v_c : (b, w, c) \in Ov(\mathcal{B}), b = b^lw\} \quad \text{for } b \in \mathcal{B}$$

has a unique solution in the power series ring  $\mathbb{Q}[[\Sigma]]$ .

The following theorem generalises (to the case of infinite  $\mathcal{B}$  and non-commuting variables) a specialisation (to the case of forbidding all occurrences of  $\mathcal{B}$  rather than determining the type of the occurrences of  $\mathcal{B}$  in a word) of Theorem 2.86 in [GJ83], often called the Goulden-Jackson cluster method. In [Zei02] an informal treatment of an equivalent method can also be found. A full generalisation of the original theorem could be obtained by adding tagging variables  $y_b$  (commuting with each other and with  $\Sigma$ ) to the system (4.1), but the version below is adequate for our purposes.

**Theorem 4.1.** *The generating function over  $\mathbb{Q}[[\Sigma]]$  of  $\Sigma^* \setminus \Sigma^*\mathcal{B}\Sigma^*$  is:*

$$\left(1 - \Sigma + \sum_{b \in \mathcal{B}} v_b\right)^{-1}$$

where  $\{v_b : b \in \mathcal{B}\}$  are defined by (4.1).

PROOF. The proof of this theorem can be read off from the proof of the theorem cited above. However, at least in this form, it is really simply a restatement of the principle of inclusion/exclusion. Define a  $\mathcal{B}$ -marking of a word  $w$  in  $\Sigma^*$  to be a specific identification of certain factors of  $w$  which belong to  $\mathcal{B}$  (not necessarily any or all such factors). If we assign the value  $(-1)^k w$  to each  $\mathcal{B}$ -marking of  $w$  in which  $k$  factors from  $\mathcal{B}$  are marked then the sum over all the  $\mathcal{B}$  markings of a word  $w$  will be 0 if  $w$  contains a  $\mathcal{B}$ -factor, and  $w$  if it does not. By considering the expression above as a geometric series it is easy to see that the coefficient of  $w$  is exactly this sum over  $\mathcal{B}$ -markings of  $w$ , and hence the expression represents the generating function of  $\mathcal{B}$ -factor-free words.  $\square$

As remarked in [Zei02], in the case of infinite structureless  $\mathcal{B}$  this does not give an equation for the generating function in any usual sense. However, in our application below, the language  $\mathcal{B}$  will carry sufficient structure that we can make effective use of Theorem 4.1.

Note that if we turn to the ordinary generating function for the language of  $\mathcal{B}$ -factor-free words, then its radius of convergence is the smallest positive root of the equation:

$$1 - |\Sigma|t + \sum_{b \in \mathcal{B}} v_b(t)$$

where we also have:

$$v_b(t) = t^{|b|} - \sum \left\{ t^{|b^l|} v_c(t) : (b, w, c) \in Ov(\mathcal{B}), b = b^l w \right\} \quad \text{for } b \in \mathcal{B}.$$

**Remark 4.2.** In general it is not the case that the system of linear equations defined above has the required property to allow an iterative solution after specializing to a single variable, even if the value chosen for the variable lies inside the radius of convergence of the series which form its solution in  $\mathbb{Q}[[t]]$ . This fails, for example, in the case  $\mathcal{B} = \{aaa, aba\}$  over the alphabet  $\{a, b\}$ .

## 5. Submeanders and upper bounds

We now apply the results of the preceding section in order to obtain upper bounds on the exponential growth rate of the meander language  $\mathcal{M}$ . Ideally, the language of forbidden words which we would like to consider consists of all words which define some closed loop, or submeander. That is, a word is forbidden if it is of the form  $U \cdots D$  where the final symbol closes off the pair of segments created by the initial one. Let  $\mathcal{B}$  be the language of such words. If an element of  $\mathcal{B}$  occurs as a *proper* factor of a word  $m$  then  $m \notin \mathcal{M}$ . It is clear though that the growth rates for the languages of  $\mathcal{B}$ -factor-free words and proper  $\mathcal{B}$ -factor-free words are the same, so we do not need to worry about that distinction. Henceforth we fix the alphabet  $\Sigma = \{U, D, R, L\}$ .

The shortest word in  $\mathcal{B}$  is  $UD$ . However, this single word is really a representative of a much wider family of forbidden words. Among these are  $URLD$ , and  $UURDLLD$ . Generally if  $S$  is any shift of displacement 0, then  $USD$  is a forbidden word. It is worth noting that there is no requirement that the words in  $\mathcal{B}$  be balanced with respect to  $U$  and  $D$ . For example, the word  $URULLD$  is in  $\mathcal{B}$ , since the final  $D$  forms a submeander with the original  $U$ , and so if this word occurs as a factor of some longer word  $w$  then  $w$  cannot represent a meander.

There is an equivalence relation defined on words by taking the transitive closure of the relation obtained by allowing the replacement of a shift, by any other shift of the same displacement. Each equivalence class of this relation contains a representative with the property that any maximal shift factor lies in  $L^*$  or  $R^*$ . Let us call these representatives the *standard representatives* of their classes. Note also that  $\mathcal{B}$  is closed under this equivalence relation.

**Lemma 5.1.** *Let a word  $w$  be given. Its standard representative is obtained by replacing the maximal shift factors of  $w$  by blocks of  $L$ 's or  $R$ 's of the same displacement.*

**PROOF.** This follows immediately from the observation that two shift factors of  $w$  cannot overlap unless their overlap is also a shift. This is because a proper suffix of a shift which is not a shift and begins with  $U$  contains more  $D$ 's than  $U$ 's, and no prefix of a shift word has this property. Since shifts are closed under concatenation, the maximal shift factors of  $w$  are disjoint and properly separated, and so the standard representative is obtained in the manner described.  $\square$

Using this result we obtain:

**Proposition 5.2.** *Let  $b, c \in \mathcal{B}$  have an overlap  $w$ . Then the standard representatives of  $b$  and  $c$  also have an overlap, which is the image of  $w$  under the replacement described in Lemma 5.1.*

**PROOF.** The word  $w$  has the form  $UuD$ . Moreover in  $b$  the terminal  $D$  closes the segments formed by the initial  $U$  of  $b$  so, interpreted in isolation, it does not close any segment created within  $u$  and so cannot be part of any shift factor of  $w$ . The same idea applies to the observation that the initial  $U$  of  $c$  is matched by its final  $D$  and so shows that the original  $U$  of  $w$  can also not be part of any shift factor of  $w$ . So the shift factors of  $b$  and  $c$  which occur within  $w$ , occur within  $u$ . Therefore the reduction of Lemma 5.1 affects  $w$  in the same way in both  $b$  and  $c$ .  $\square$

Let  $\mathcal{B}_{\text{rep}}$  be the sublanguage of  $\mathcal{B}$  consisting of the standard representatives of the elements of  $\mathcal{B}$ . For any word  $w$  let  $\bar{w}$  be the generating function of its equivalence class. Now consider a modification of the system of equations (4.1)

$$(5.1) \quad x_b = \bar{b} - \sum \{ \bar{b}^l x_c : (b, w, c) \in \text{Ov}(\mathcal{B}_{\text{rep}}), b = b^l w \} \quad \text{for } b \in \mathcal{B}_{\text{rep}}.$$

Then, it follows directly from Proposition 5.2 that:

$$\sum_{b \in \mathcal{B}} v_b = \sum_{b \in \mathcal{B}_{\text{rep}}} x_b$$

(where  $v_b$  is defined by the system of equations (4.1)).

Thus we may use the latter form in computations arising from Theorem 4.1. For instance, we could use a finite subset of the original language  $\mathcal{B}$ , and also place some restrictions on the shift words used in constructing  $\bar{w}$  from  $w$ .

For example, take as forbidden language  $\mathcal{B}_0$ , the single forbidden word  $UD$ , and its expansions  $USD$  where  $S \in \{R, L\}^*$  has displacement 0. Then the generating function for  $\mathcal{B}_0$ -factor-free words is:

$$\frac{1}{1 - 4t + \frac{t^2}{\sqrt{1-4t^2}}}.$$

The radius of convergence of this generating function is the smallest positive solution of

$$65t^4 - 32t^3 - 12t^2 + 8t - 1 = 0$$

whose approximate value is 0.272054. Since  $\mathcal{B}_0$  represents a subset of the actual words forbidden to appear as factors in a meander word, this gives an upper bound of 13.5111 on  $M$ .

In the next section we will describe in greater detail how these results can be used to provide bounds for  $M$  in situations where we cannot analytically solve the equations for the radius of convergence.

## 6. Computational methodology

In this section we give an overview of the computational methods used to evaluate lower and upper bounds on  $M$ .

**6.1. Lower bounds.** In computing lower bounds on the exponential growth rate for the meander generating function, we attempt to construct a generating function based on a subset of the set of shifts, built up from a subset of the primitive jumps. Generally, we make use of all the primitive jumps containing at most some preset number of symbols. These are constructed by simulating the extended meander environment and carrying out a depth-first search. The only extra information which must be maintained is a record of the new segments present when each  $U$  occurs. This must then be compared to the  $D$  which eliminates the segment created by the  $U$  in order to ensure that the only shift factors are in  $L^*$  and  $R^*$ .

The results quoted below are for primitive jumps containing a maximum of 24 symbols. There are 875,938 such primitive jumps with non-negative displacement. On the other hand, there are only 25,264 of length at most 20, and only the following 13 of length at most 10:

*URD, UURRDD, UULLDRRD, UURRDLDD, ULLURRDD,  
URRULLDD, UUURRRDDD, ULURRRDLDD, ULUURRDRDD,  
URRULLDRRD, UURURRDLDD, UULURRRDDD, UUURRRDLDD.*

The basic computational scheme employed is a simple iterative one. We establish at the outset an arbitrary bound on the number of jumps which will be concatenated to form a shift (in practice 50 is more than adequate). Then we take an existing set of jumps and compute a new set of shifts by concatenating

them in this way. These new shifts are in turn substituted into our supply of primitive jumps in order to compute a new set of jumps and so on.

All of this is handled numerically by passing at the outset to generating functions in a single variable  $t$  (which replaces each of the letters of the meander alphabet). For a fixed real value of  $t$  we can then carry out the computation described above. If the value of  $t$  lies outside of the radius of convergence of the generating function then the iteration will diverge. It is easy to establish strict divergence criteria for this iteration. For example, the RHS of the equation defining  $s_0$  dominates the one which would define an ordinary one-dimensional drunkard's walk, that is,  $1 + t^2 s_0^2$ . In particular, if ever  $s_0 > 1/t^2$  then each successive iteration must increase  $s_0$  by at least 1, and hence divergence is established. We can make use of a loose convergence criterion (no divergence through some fixed number of iterations), since lower bounds on  $M$  are determined by upper bounds on the radius of convergence of the generating function. Then a simple binary search on  $t$  allows us to determine rigorous upper bounds on the radius of convergence for  $s_0(t)$ .

Using jumps of length up to 24, we obtain an upper bound for the radius of convergence of  $s_0(t)$  of 0.296431. This translates to a lower bound of 11.38 on  $M$ .

Given that our supply of primitive jumps is finite, there is a bound on the displacement of each jump. Using this it is possible to compute exact values for shifts made up of arbitrarily many such jumps using standard techniques from the enumeration of drunkard's walks. In practice this scheme suffers from a number of drawbacks. First, it is computationally much more expensive and complex than the simple iteration. Second, the results obtained are not significantly better than those obtained by simple iteration since the dominant terms for shifts will in any case be composed of relatively few jumps. Finally, allowing arbitrarily many jumps per shift would require verification that almost all such shifts still remain within the meander context. Since our primitive shifts are of bounded displacement, we can guarantee that the excursions away from the original centre of the meander context are "not large" except in a vanishing proportion of cases, and so almost all of the words which we (implicitly) enumerate through the recursive scheme are legitimate.

**6.2. Upper bounds.** In producing upper bounds for the growth rate of meander numbers we begin from a set  $\mathcal{B}$  of standard representatives of words creating a submeander. Again, the most straightforward approach is simply to list all such words up to some predefined length. Doing this again involves a depth-first search in the extended meander environment. This time we must check that the final  $D$  joins the segments formed by the initial  $U$ , that no earlier  $D$  creates a sub-meander, and that no jumps occur as subwords other than  $L$  and  $R$ . All these tests are easily implemented within the meander environment.

After passing to a single variable  $t$  we use equation (5.1) in order to compute the quantities  $x_b$ . Rather than solving this large (but relatively sparse) system exactly we may use a simple iterative scheme since it is easily checked that for values of  $t$  in the range we are interested in there are no eigenvalues of the matrix representing the summations on the RHS of this equation whose modulus is greater than or equal to 1. Convergence is therefore guaranteed, with error bounds decreasing by a constant factor on each iteration. Having computed the values  $x_b$ , all that is necessary is to evaluate the sign of

$$1 - 4t + \sum_{b \in \mathcal{B}} x_b(t)$$

in order to determine whether  $t$  lies above or below the radius of convergence (below if the sign is positive, above if it is negative). Again a simple binary search can now be used to estimate the radius of convergence, and hence an upper bound on the exponential growth of the meander numbers.

Using the 20509 words of length 16 which are standard representatives of words creating a submeander for  $\mathcal{B}$  produces an estimate of 0.2784 for the radius of convergence of  $\mathcal{B}$ -factor-free words, and hence an upper bound of 12.901 on  $M$ .

Lower bounds		Upper bounds	
10	10.749	6	13.171
12	10.928	8	13.086
14	11.023	10	13.018
16	11.114	12	12.970
18	11.188	14	12.931
20	11.249	16	12.901
22	11.301		
24	11.380		

TABLE 1. Lower and upper bounds on  $M$  based on maximum length of jumps, and submeanders.

## 7. Summary and conclusions

Obviously the methods which we have applied could be extended to obtain better bounds through more extensive computation using longer words as primitive jumps, or as the standard representatives of submeander words. Some indication of how far this might or might not progress is shown in Table 1.

A simple extrapolation based on this data suggests a limiting lower bound of approximately 11.6, and an upper bound of approximately 12.8. However, the final lower bound which we have computed (from jumps up to length 24) represents a better than expected improvement on the previous value. Put another way, there are more jumps of length 24 than one would expect based on simple extrapolation of previous values. So, it may be that better improvements on the lower bound are possible.

## References

- [DF00] P. Di Francesco, *Exact asymptotics of meander numbers*, Formal power series and algebraic combinatorics (Moscow, 2000), Springer, Berlin, 2000, pp. 3–14. MR **2001i**:05016
- [DFGG00] P. Di Francesco, O. Golinelli, and E. Guitter, *Meanders: exact asymptotics*, Nuclear Phys. B **570** (2000), no. 3, 699–712. MR **2001f**:82032
- [DFGJ00] P. Di Francesco, E. Guitter, and J. L. Jacobsen, *Exact meander asymptotics: a numerical check*, Nuclear Phys. B **580** (2000), no. 3, 757–795. MR **2002b**:82024
- [FE02] Reinhard O. W. Franz and Berton A. Earnshaw, *A constructive enumeration of meanders*, Ann. Comb. **6** (2002), no. 1, 7–17. MR **2003f**:05004
- [GJ79] I. P. Goulden and D. M. Jackson, *An inversion theorem for cluster decompositions of sequences with distinguished subsequences*, J. London Math. Soc. (2) **20** (1979), no. 3, 567–576. MR **83b**:05005
- [GJ83] ———, *Combinatorial enumeration*, A Wiley-Interscience Publication, John Wiley & Sons Inc., New York, 1983, With a foreword by Gian-Carlo Rota, Wiley-Interscience Series in Discrete Mathematics. MR **84m**:05002
- [Jen00] Iwan Jensen, *A transfer matrix approach to the enumeration of plane meanders*, Journal of Physics A: Mathematical and General **33** (2000), no. 34, 5953–5963.
- [JG00] Iwan Jensen and Anthony J Guttmann, *Critical exponents of plane meanders*, Journal of Physics A: Mathematical and General **33** (2000), no. 21, L187–L192.
- [LZ93] S. K. Lando and A. K. Zvonkin, *Plane and projective meanders*, Theoret. Comput. Sci. **117** (1993), no. 1-2, 227–241, Conference on Formal Power Series and Algebraic Combinatorics (Bordeaux, 1991). MR **94i**:05004
- [NZ99] John Noonan and Doron Zeilberger, *The Goulden-Jackson cluster method: extensions, applications and implementations*, J. Differ. Equations Appl. **5** (1999), no. 4-5, 355–377. MR **2000f**:05005
- [Zei02] Doron Zeilberger, *The umbral transfer-matrix method. V. The Goulden-Jackson cluster method for infinitely many mistakes*, Integers **2** (2002), Paper A5, 12 pp. (electronic). MR **2003f**:05010

DEPARTMENT OF COMPUTER SCIENCE, UNIVERSITY OF OTAGO, DUNEDIN, NEW ZEALAND  
*E-mail address*: malbert@cs.otago.ac.nz

DEPARTMENT OF COMPUTER SCIENCE, UNIVERSITY OF WARWICK, COVENTRY, UK  
*E-mail address*: msp@dcs.warwick.ac.uk





# The Bergman Complex of a Matroid and Phylogenetic Trees

Federico Ardila and Caroline J. Klivans

**Abstract.** *We study the Bergman complex  $\mathcal{B}(M)$  of a matroid  $M$ : a polyhedral complex which arises in algebraic geometry, but which we describe purely combinatorially. We prove that a natural subdivision of the Bergman complex of  $M$  is a geometric realization of the order complex of its lattice of flats. In addition, we show that the Bergman fan  $\tilde{\mathcal{B}}(K_n)$  of the graphical matroid of the complete graph  $K_n$  is homeomorphic to the space of phylogenetic trees  $\mathcal{T}_n$ .*

## 1. Introduction

In [1], Bergman defined the *logarithmic limit-set* of an algebraic variety in order to study its exponential behavior at infinity. We follow [15] in calling this set the *Bergman complex* of the variety. Bergman conjectured that this set is a finite, pure polyhedral complex. He also posed the question of studying the geometric structure of this set; *e.g.*, its connectedness, homotopy, homology and cohomology. Bieri and Groves first proved the conjecture in [2] using valuation theory.

Recently, Bergman complexes have received considerable attention in several areas, such as tropical algebraic geometry and dynamical systems. They are the *non-archimedean amoebas* of [7] and the *tropical varieties* of [15, 13]. In particular, Sturmfels [15] gave a new description of the Bergman complex and an alternative proof of Bergman's conjecture in the context of Gröbner basis theory. Moreover, when the variety is a linear space, so the defining ideal  $I$  is generated by linear forms, he showed that the Bergman complex can be described solely in terms of the matroid associated to the linear ideal.

Sturmfels used this description to define the Bergman complex of an arbitrary matroid, and suggested studying its combinatorial, geometric and topological properties [15]. The goal of the paper is to undertake this study.

In Section 2 we study the collection of bases of minimum weight of a matroid. We show that this collection is itself the collection of bases of a matroid, and we give several descriptions of it.

In Section 3 we prove the main result of the paper. We show that, appropriately subdivided, the Bergman complex of a matroid  $M$  is the order complex of the proper part of the lattice of flats  $L_M$  of the matroid. These order complexes are well-understood objects [4], and an immediate corollary of our result is an answer to Bergman's questions about the geometry of  $\mathcal{B}(M)$  in this special case. The Bergman complex of an arbitrary matroid  $M$  is a finite, pure polyhedral complex. In fact, it is homotopy equivalent to a wedge of  $(r - 2)$ -dimensional spheres, where  $r$  is the rank of  $M$ .

In Section 4, we take a closer look at the Bergman complex of the graphical matroid of the complete graph  $K_n$ . We show that the Bergman fan  $\tilde{\mathcal{B}}(K_n)$  is exactly the space of ultrametrics on  $[n]$ , which is homeomorphic to the space of phylogenetic trees as in [3]. As a consequence, we show that the order complex of the partition

---

1991 *Mathematics Subject Classification.* Primary 05B35, 52B05, 92B10.

*Key words and phrases.* matroids, phylogenetics trees, discrete geometry.

lattice  $\Pi_n$  is a subdivision of the link of the origin of this space. This provides a new explanation for the known result that these two simplicial complexes are homotopy equivalent [11, 16, 17, 18, 19].

Finally, in the appendix, we review some matroid theory which we will use throughout the paper. For a more thorough introduction, we refer the reader to [9].

## 2. The bases of minimum weight of a matroid

Let  $M$  be a matroid of rank  $r$  on the ground set  $[n] = \{1, 2, \dots, n\}$ , and let  $\omega \in \mathbb{R}^n$ . Regard  $\omega$  as a weight function on  $M$ , so that the weight of a basis  $B = \{b_1, \dots, b_r\}$  of  $M$  is given by  $\omega_B = \omega_{b_1} + \omega_{b_2} + \dots + \omega_{b_r}$ .

Let  $M_\omega$  be the collection of bases of  $M$  having minimum  $\omega$ -weight. This is one of the central objects of our study, and we wish to understand it from three different points of view: geometric, algorithmic and matroid theoretic.

Geometrically, we can understand  $M_\omega$  in terms of the matroid polytope. We will use the following characterization of matroid polytopes, due to Gelfand and Serganova:

**Theorem 2.1.** [6, Theorem 1.11.1] *Let  $S$  be a collection of  $r$ -subsets of  $[n]$ . Let  $P_S$  be the polytope in  $\mathbb{R}^n$  with vertex set  $\{e_{b_1} + \dots + e_{b_r} \mid \{b_1, \dots, b_r\} \in S\}$ , where  $e_i$  is the  $i$ -th unit vector. Then  $S$  is the collection of bases of a matroid if and only if every edge of  $P_S$  is a translate of the vector  $e_i - e_j$  for some  $i, j \in [n]$ .*

Let  $P_M$  be the matroid polytope of  $M$ . We can now think of  $\omega$  as a linear functional in  $\mathbb{R}^n$ . The bases in  $M_\omega$  correspond to the vertices of  $P_M$  which minimize the linear functional  $\omega$ . Their convex hull is  $P_{M_\omega}$ , the face of  $P_M$  where  $\omega$  is minimized. It follows that the edges of  $P_{M_\omega}$ , being edges of  $P_M$  also, are parallel to vectors of the form  $e_i - e_j$ . Therefore  $M_\omega$  is the collection of bases of a matroid.

Algorithmically, matroids have the property that their  $\omega$ -minimum bases are precisely the possible outputs of the greedy algorithm: Start with  $B = \emptyset$ . At each stage, look for an  $\omega$ -minimum element of  $[n]$  which can be added to  $B$  without making it dependent, and add it. After  $r$  steps, output the basis  $B$ . [9, Theorem 1.8.5]

**Definition 2.2.** Given  $\omega \in \mathbb{R}^n$ , let  $\mathcal{F}(\omega)$  denote the unique flag of subsets

$$\emptyset =: F_0 \subset F_1 \subset \dots \subset F_k \subset F_{k+1} := E$$

for which  $\omega$  is constant on each set  $F_i - F_{i-1}$  and has  $\omega|_{F_i - F_{i-1}} < \omega|_{F_{i+1} - F_i}$ . The *weight class* of a flag  $\mathcal{F}$  is the set of vectors  $\omega$  such that  $\mathcal{F}(\omega) = \mathcal{F}$ .

We can describe weight classes by their defining equalities and inequalities. For example, one of the weight classes in  $\mathbb{R}^5$  is the set of vectors  $\omega$  such that  $\omega_1 = \omega_4 < \omega_2 < \omega_3 = \omega_5$ . It corresponds to the flag  $\{\emptyset \subset \{1, 4\} \subset \{1, 2, 4\} \subset \{1, 2, 3, 4, 5\}\}$ .

**Proposition 2.3.** *If  $\omega$  is in the weight class of  $\mathcal{F} = \{\emptyset =: F_0 \subset \dots \subset F_{k+1} := E\}$ , then the  $\omega$ -minimum bases of  $M$  are exactly those containing  $r(F_i) - r(F_{i-1})$  elements of  $F_i - F_{i-1}$ , for each  $i$ . Consequently,  $M_\omega$  depends only on  $\mathcal{F}$ , and we call it  $M_{\mathcal{F}}$ .*

**PROOF.** The greedy algorithm picks  $r(F_1)$  elements of the lowest weight, until it reaches a basis of  $F_1$ ; then it picks  $r(F_2) - r(F_1)$  elements of the second lowest weight, until it reaches a basis of  $F_2$ , and so on. Therefore, the possible outputs of the algorithm are precisely the ones described.  $\square$

Matroid theoretically,  $M_\omega$  can be constructed as a direct sum of minors of  $M$ , and its lattice of flats  $L_{M_\omega}$  can be constructed from intervals of  $L_M$ , as follows:

**Proposition 2.4.** *If  $\mathcal{F} = \{\emptyset =: F_0 \subset \dots \subset F_{k+1} := E\}$ , then*

$$M_{\mathcal{F}} = \bigoplus_{i=1}^{k+1} (M|_{F_i}/F_{i-1}) \quad \text{and} \quad L_{M_{\mathcal{F}}} \cong \prod_{i=1}^{k+1} [F_{i-1}, F_i].$$

PROOF. After  $r(F_{i-1})$  steps, the greedy algorithm has chosen a basis of  $F_{i-1}$ . In the following  $r(F_i) - r(F_{i-1})$  steps, it needs to choose elements which, when added to  $F_{i-1}$ , give a basis of  $F_i$ . The possible choices are, precisely, the bases of  $(M|F_i)/F_{i-1}$ . The first equality follows, and the second one follows from it.  $\square$

### 3. The Bergman complex

We now define the two main objects of study of this paper.

**Definition 3.1.** The *Bergman fan* of a matroid  $M$  with ground set  $[n]$  is the set

$$\tilde{\mathcal{B}}(M) := \{\omega \in \mathbb{R}^n : M_\omega \text{ has no loops}\}.$$

The *Bergman complex* of  $M$  is

$$\mathcal{B}(M) := \{\omega \in S^{n-2} : M_\omega \text{ has no loops}\},$$

where  $S^{n-2}$  is the sphere  $\{\omega \in \mathbb{R}^n : \omega_1 + \cdots + \omega_n = 0, \omega_1^2 + \cdots + \omega_n^2 = 1\}$ .

For the moment, we are slightly abusing notation by calling these two objects a *fan* and a *complex*. We will very soon see that they are a polyhedral fan and a spherical polyhedral complex, respectively; this justifies their name. We will concentrate on the Bergman complex, but the same arguments apply to the Bergman fan.

**Definition 3.2.** The weight class of a flag  $\mathcal{F}$  is *valid* for  $M$  if  $M_{\mathcal{F}}$  has no loops.

Since the matroid  $M_\omega$  only depends on the weight class that  $\omega$  is in, the Bergman complex of  $M$  is a disjoint union of the following weight classes:

**Definition 3.3.** The weight class of a flag  $\mathcal{F}$  is *valid* for  $M$  if  $M_{\mathcal{F}}$  has no loops.

We will study two polyhedral subdivisions of  $\mathcal{B}(M)$ , one of which is clearly finer than the other.

**Definition 3.4.** The *fine subdivision* of  $\mathcal{B}(M)$  is the subdivision of  $\mathcal{B}(M)$  into valid weight classes: two vectors  $u$  and  $v$  of  $\mathcal{B}(M)$  are in the same class if and only if  $\mathcal{F}(u) = \mathcal{F}(v)$ .

The *coarse subdivision* of  $\mathcal{B}(M)$  is the subdivision of  $\mathcal{B}(M)$  into  $M_\omega$ -equivalence classes: two vectors  $u$  and  $v$  of  $\mathcal{B}(M)$  are in the same class if and only if  $M_u = M_v$ .

**Theorem 3.5.** *The weight class of a flag  $\mathcal{F}$  is valid for  $M$  if and only if  $\mathcal{F}$  is a flag of flats of  $M$ . Therefore, the fine subdivision of the Bergman complex  $\mathcal{B}(M)$  is a geometric realization of  $\Delta(L_M - \{\hat{0}, \hat{1}\})$ , the order complex of the proper part of the lattice of flats of  $M$ .*

PROOF. Assume  $F_i$  in  $\mathcal{F}$  is not a flat of  $M$ , so there exists some  $e \in \overline{F_i} - F_i$ . By Proposition 2.3, any basis  $B$  in  $M_{\mathcal{F}}$  contains  $r(F_i)$  elements of  $F_i$ ; since  $e$  is dependent on them, it cannot be in  $B$ . Hence  $e$  is a loop in  $M_{\mathcal{F}}$ , so the weight class of  $\mathcal{F}$  is not valid.

Conversely, assume every  $F_i$  in  $\mathcal{F}$  is a flat of  $M$ . Consider any  $e \in E$ , and find the value of  $i$  such that  $e \in F_i - F_{i-1}$ . After  $r(F_{i-1})$  steps the greedy algorithm produces a basis of  $F_{i-1}$ . Since  $F_{i-1}$  is a flat,  $e$  is not dependent on it, and in the next step of the algorithm we can choose  $e$ . In the end, this produces an  $\omega$ -minimum basis of  $M$  containing  $e$ . Therefore the weight class of  $\mathcal{F}$  is valid.  $\square$

The order complex  $\Delta(L_M - \{\hat{0}, \hat{1}\})$  is a well understood object [4]. As an immediate consequence of Theorem 3.5, we get the following result.

**Corollary 3.6.** *The Bergman complex  $\mathcal{B}(M)$  is homotopy equivalent to a wedge of  $\widehat{\mu}(L_M)$   $(r-2)$ -dimensional spheres. Its subdivision into weight classes is a pure, shellable simplicial complex.*

Here  $\widehat{\mu}(L_M) = (-1)^{r(M)} \mu_{L_M}(\hat{0}, \hat{1})$  is an evaluation of the *Möbius function*  $\mu_{L_M}$  of the lattice  $L_M$ . The Möbius function is an extremely useful combinatorial invariant of a poset; for more information, see [14, Chapter 3].

**Example:** Let  $M$  be the graphical matroid of the complete graph on four nodes. The bases of this matroid are given by spanning trees. The flats are complete subgraphs and vertex disjoint unions of complete subgraphs (see Figure 1). Note that in this case, the flats are in correspondence with the partitions of the

set  $\{A, B, C, D\}$ . In general, the flats of the graphical matroid of  $K_n$  are in bijection with partitions of the set  $[n]$ . Furthermore, the lattice of flats is the partition lattice  $\Pi_n$ , which orders partitions by refinement.

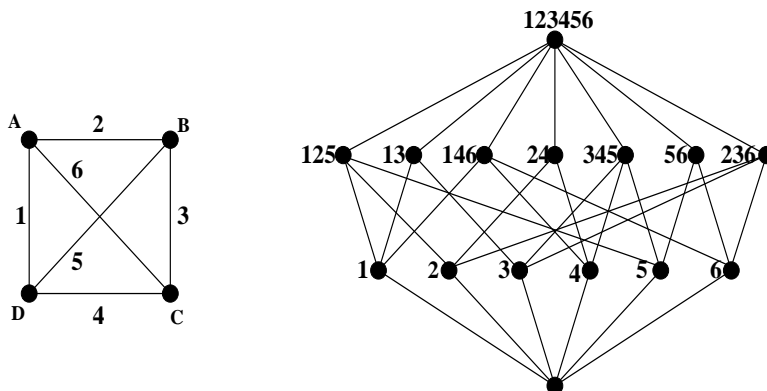

FIGURE 1. The graph  $K_4$  and the lattice of flats of the corresponding matroid.

The Bergman complex  $\mathcal{B}(K_4)$  is shown in Figure 2. It is a wedge of six 1-spheres. More generally,  $\mathcal{B}(K_n)$  is a wedge of  $\hat{\mu}(\Pi_n) = (n - 1)!$  spheres of dimension  $n - 3$ . The vertices of  $\mathcal{B}(K_4)$  are labeled with the corresponding flats, and a few of the corresponding weight classes are shown. Notice that the ground set of a matroid is always a flat, which corresponds to the weight class in which all weights are equal. We removed this weight class when normalizing the Bergman complex to the sphere.

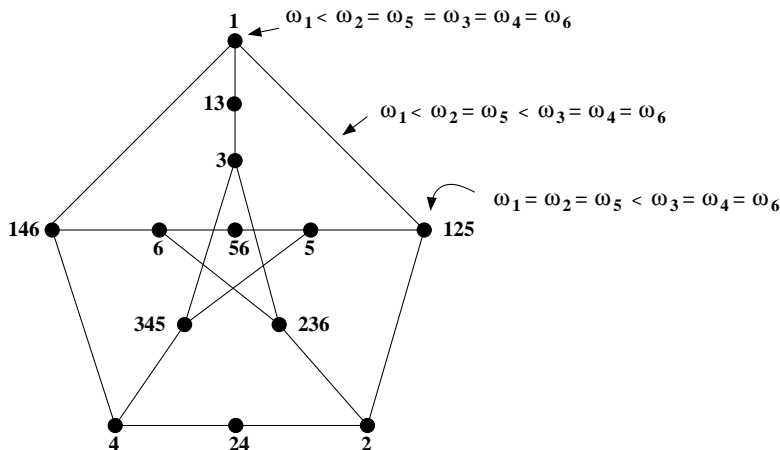

FIGURE 2. The Bergman complex of the graphical matroid of  $K_4$ .

The fine subdivision of the Bergman complex is almost the Petersen graph. The only difference is the presence of the three extra vertices, 13, 24 and 56. In the coarse subdivision into  $M_\omega$ -equivalence classes, these three vertices do not appear. For example, the weight class  $\omega_1 < \omega_3 < \omega_2 = \omega_4 = \omega_5 = \omega_6$  induces the same matroid  $M_\omega$  as  $\omega_1 = \omega_3 < \omega_2 = \omega_4 = \omega_5 = \omega_6$  and  $\omega_3 < \omega_1 < \omega_2 = \omega_4 = \omega_5 = \omega_6$ . Next we describe the relationship between these two subdivisions in general.

The coarse decomposition of  $\mathcal{B}(M)$  into cells which induce the same  $M_\omega$  is also a pure, polyhedral complex: it is a subcomplex of the spherical polar to the matroid polytope of  $M$ . To describe this decomposition, it is enough to describe its full-dimensional cells.

Therefore, we only need to determine when two full-dimensional weight classes give the same matroid  $M_\omega$ . It is clearly enough to answer this question when the two weight classes are *adjacent*; *i.e.*, the intersection of their closures is a facet of both. This happens when the two corresponding flags, which have one flat in each rank, are equal in all but one rank.

Let  $\diamond$  be the *diamond poset*; *i.e.*, the rank 2 poset consisting of a minimum element, a maximum element, and two rank 1 elements.

**Theorem 3.7.** *Suppose that the weight classes of two maximal flags  $\mathcal{F}$  and  $\mathcal{F}'$  are adjacent. Say  $\mathcal{F}$  and  $\mathcal{F}'$  only differ in rank  $i$ ; that is,  $\mathcal{F} - F_i = \mathcal{F}' - F'_i$ . Then the following conditions are equivalent:*

- (i)  $M_{\mathcal{F}} = M_{\mathcal{F}'}$ .
- (ii)  $M_{\mathcal{F}} = M_{\mathcal{F} - F_i}$ .
- (iii)  $F_i \cup F'_i = F_{i+1}$ .
- (iv) *The interval  $[F_{i-1}, F_{i+1}]$  of  $L_M$  is a diamond poset.*

PROOF. Let  $M_j = (M|F_j)/F_{j-1}$ ,  $M'_j = (M|F'_j)/F'_{j-1}$ ,  $N_i = (M|F_{i+1})/F_{i-1}$ , and  $N = M_1 \oplus \cdots \oplus M_{i-1} \oplus M_{i+2} \oplus \cdots \oplus M_{k+1}$ . By Proposition 2.4,

$$M_{\mathcal{F}} = N \oplus M_i \oplus M_{i+1}, \quad M_{\mathcal{F}'} = N \oplus M'_i \oplus M'_{i+1}, \quad M_{\mathcal{F} - F_i} = N \oplus N_i.$$

Since  $M_i, M_{i+1}, M'_i$  and  $M'_{i+1}$  have rank 1 and  $N_i$  has rank 2,

$$\begin{aligned} L_{M_i \oplus M_{i+1}} &= \{\emptyset, F_i - F_{i-1}, F_{i+1} - F_i, F_{i+1} - F_{i-1}\} \cong \diamond, \\ L_{M'_i \oplus M'_{i+1}} &= \{\emptyset, F'_i - F_{i-1}, F_{i+1} - F'_i, F_{i+1} - F_{i-1}\} \cong \diamond, \\ L_{N_i} &= \{F - F_{i-1} : F \in [F_{i-1}, F_{i+1}]\} \cong [F_{i-1}, F_{i+1}]. \end{aligned}$$

If (iv) does not hold, then we know immediately that  $L_{N_i} \neq L_{M_i \oplus M_{i+1}}$ . Also  $F_i \cup F'_i \neq F_{i+1}$ , and therefore  $L_{M_i \oplus M_{i+1}} \neq L_{M'_i \oplus M'_{i+1}}$ .

If (iv) holds, then  $F_i$  and  $F'_i$  are the only rank  $i$  flats of  $M$  in  $[F_{i-1}, F_{i+1}]$ . Since  $N_i$  has no loops, (iii) holds; and therefore  $L_{M_i \oplus M_{i+1}} = L_{M'_i \oplus M'_{i+1}} = L_{N_i}$ .  $\square$

#### 4. The space of phylogenetic trees

In this section, we show that the Bergman fan  $\tilde{\mathcal{B}}(K_n)$  of the matroid of the complete graph  $K_n$  is homeomorphic to the space of phylogenetic trees  $\mathcal{T}_n$ , as defined in [3]. To do so, we start by reviewing the connection between phylogenetic trees and ultrametrics.

**Definition 4.1.** A *dissimilarity map* on  $[n]$  is a map  $\delta : [n] \times [n] \rightarrow \mathbb{R}$  such that  $\delta(i, i) = 0$  for all  $i \in [n]$ , and  $\delta(i, j) = \delta(j, i)$  for all  $i, j \in [n]$ .

**Definition 4.2.** A dissimilarity map is an *ultrametric* if, for all  $i, j, k \in [n]$ , two of the values  $\delta(i, j), \delta(j, k)$  and  $\delta(i, k)$  are equal and not less than the third.

Let  $T$  be a rooted metric  $n$ -tree; that is, a tree with  $n$  leaves labeled  $1, 2, \dots, n$ , together with a length assigned to each one of its edges. For each pair of leaves  $u, v$  of the tree, we define the *distance*  $d_T(u, v)$  to be the length of the unique path joining leaves  $u$  and  $v$  in  $T$ . This gives us a distance function  $d_T : [n] \times [n] \rightarrow \mathbb{R}$ . We will only consider *equidistant  $n$ -trees*. These are the rooted metric  $n$ -trees such that the distance between the root and any leaf is equal to 1, and the lengths of the interior edges are positive. (For technical reasons, the edges incident to a leaf are allowed to have negative lengths.)

We can think of equidistant trees as a model for the evolutionary relationships between a certain set of species. The various species, represented by the leaves, descend from a single root. The descent from the root to a leaf tells us the history of how a particular species branched off from the others. For more information on the applications of this and other similar models, see for example [3] and [12].

The connection between equidistant trees and ultrametrics is given by the following theorem.

**Theorem 4.3.** [12, Theorem 7.2.5] *A map  $\delta : [n] \times [n] \rightarrow \mathbb{R}$  is an ultrametric if and only if it is the distance function of an equidistant  $n$ -tree.*

We can think of a dissimilarity map  $\delta : [n] \times [n] \rightarrow \mathbb{R}$  as a weight function  $\omega_\delta$  on the edges of the complete graph  $K_n$ . This leads us to the following result, which connects these ideas to the Bergman fan.

**Theorem 4.4.** *A dissimilarity map  $\delta : [n] \times [n] \rightarrow \mathbb{R}$  is an ultrametric if and only if  $\omega_\delta$  is in the Bergman fan  $\tilde{\mathcal{B}}(K_n)$ .*

PROOF. We claim that the following three statements about a weight function on the edges of  $K_n$  are equivalent.

- (i) In any triangle, the largest weight is achieved (at least) twice.
- (ii) In any cycle, the largest weight is achieved (at least) twice.
- (iii) Every edge is in a spanning tree of minimum weight.

The theorem will follow from this claim, because ultrametrics are characterized by (i) and weight functions in the Bergman complex are characterized by (iii).

The implication (ii)  $\Rightarrow$  (i) is trivial. Conversely, assume that (i) holds and (ii) does not. Without loss of generality, assume that the cycle  $v_1v_2 \dots v_k$  has  $v_1v_2$  as its unique edge of largest weight. The largest weight in triangle  $v_1v_2v_3$  must be achieved at  $\omega(v_1v_2) = \omega(v_1v_3)$ . The largest weight in triangle  $v_1v_3v_4$  must then be achieved at  $\omega(v_1v_3) = \omega(v_1v_4)$ . Continuing in this way we get that  $\omega(v_1v_2) = \omega(v_1v_3) = \dots = \omega(v_1v_k)$ , and (ii) follows.

Now we prove (ii)  $\Rightarrow$  (iii). Consider an arbitrary edge  $f$ . Let  $T$  be a spanning tree of minimum weight. If  $f \in T$  we are done; otherwise,  $T \cup f$  has a unique cycle. There is at least one edge  $e$  in this cycle with  $\omega(e) \geq \omega(f)$ . Therefore, the weight of the spanning tree  $T \setminus e \cup f$  is not larger than the weight of  $T$ . This is then a spanning tree of minimum weight containing  $f$ .

Finally, assume that (iii) holds and (i) does not. Assume that the triangle with edges  $e, f, g$  has  $\omega(e) > \omega(f), \omega(g)$ , and consider a spanning tree  $T$  of minimum weight which contains edge  $e$ . If  $f$  is in  $T$ , then  $g$  cannot be in  $T$ , and replacing  $e$  with  $g$  will give a spanning tree of smaller weight. If neither  $f$  nor  $g$  is in  $T$ , we can still replace  $e$  with one of them to obtain a spanning tree of smaller weight. If we could not, that would imply that both  $f$  and  $g$  form a cycle when added to  $T \setminus e$ . Call these cycles  $C_f$  and  $C_g$ . But then  $(C_f \setminus f) \cup (C_g \setminus g) \cup e$  would contain a cycle in  $T$ , a contradiction.  $\square$

The previous two theorems give us a one-to-one correspondence between the vectors in the Bergman fan  $\tilde{\mathcal{B}}(K_n)$  and the equidistant  $n$ -trees:  $\tilde{\mathcal{B}}(K_n)$  parameterizes equidistant  $n$ -trees by the distances between their leaves. This leads us to consider the space of trees  $\mathcal{T}_n$  of [3]. This space parameterizes equidistant  $n$ -trees in a different way: it keeps track of their combinatorial type, and the lengths of their internal edges. We recall the construction of the space  $\mathcal{T}_n$ . Each maximal cell corresponds to a combinatorial type of rooted binary tree on  $n$  labeled leaves; *i.e.*, a rooted tree where each internal vertex has two descendants. Such trees have  $n - 2$  internal edges, and are parameterized by vectors in  $\mathbb{R}_{>0}^{n-2}$  recording these edge lengths. Moving to a lower dimensional face of a maximal cell corresponds to setting some of these edge lengths to 0, which gives non-binary degenerate cases of the original tree. Maximal cells are glued along these lower-dimensional cells when two trees specialize to the same degenerate tree.

Given a fixed combinatorial type of tree and the vector of internal edge lengths, we can recover the pairwise distances of leaves as linear functions on the internal edge lengths. For example, consider the tree type of Figure 3. We obtain  $(\delta(A, B), \delta(A, C), \delta(A, D), \delta(B, C), \delta(B, D), \delta(C, D)) \in \mathcal{B}(K_4)$  from  $(x, y)$  by the map  $f : (x, y) \mapsto (2(1 - x - y), 2(1 - y), 2, 2(1 - y), 2, 2)$ . The converse is also true; given the pairwise distances of leaves we can recover the internal edge lengths via linear relations on these distances [12].

In general, doing this for each type of tree, we get a map  $f : \mathcal{T}_n \rightarrow \tilde{\mathcal{B}}(K_n)$ . It follows from the previous two theorems that  $f$  is a one-to-one correspondence between  $\mathcal{T}_n$  and  $\tilde{\mathcal{B}}(K_n)$ . We will now see that, in fact,  $\mathcal{T}_n$  and  $\tilde{\mathcal{B}}(K_n)$  have the same combinatorial structure.

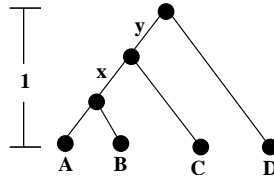

FIGURE 3. Combinatorial type of tree with 4 leaves.

**Proposition 4.5.** *The map  $f : \mathcal{T}_n \rightarrow \tilde{\mathcal{B}}(K_n)$  is a piecewise linear homeomorphism. It identifies the decomposition of the space of trees  $\mathcal{T}_n$  into combinatorial tree types with the coarse decomposition of the Bergman fan  $\tilde{\mathcal{B}}(K_n)$ .*

PROOF. Restricting to a maximal cell of  $\mathcal{T}_n$ , corresponding to a fixed tree type,  $f$  is a linear map from the lengths of internal edges (in the space of trees) to the pairwise distances of the leaves (in the space of ultrametrics). Also, it is clear that when two maximal cells of  $\mathcal{T}_n$  intersect, the linear restrictions of  $f$  to these two cells agree on their intersection. The first claim follows.

Suppose we are given a combinatorial type of equidistant  $n$ -tree. From the branching order of each triple of leaves (*i.e.*, which, if any, of the three branched off first), we can recover which edges of each triangle of  $K_n$  are maximum in the corresponding weight vector. In turn, this allows us to recover which edges of any cycle are maximum: one can check that an edge is maximum in a cycle  $C$  if and only if it is maximum in each triangle that it forms with a vertex of  $C$ . Knowing the maximum edges of each cycle of the graph, we can determine  $M_\omega$  using the following version of the greedy algorithm. Start with the complete graph  $K_n$  and break its cycles successively: at each step pick an existing cycle, and remove one of its maximum edges. The trees which can result by applying this procedure are precisely the  $\omega$ -minimum spanning trees [8]. Therefore  $f$  maps a fixed tree type class of  $\mathcal{T}_n$  to a fixed  $M_\omega$ -equivalence class; *i.e.*, a fixed cell in the coarse subdivision of  $\tilde{\mathcal{B}}(K_n)$ .

Conversely, suppose we are given  $M_\omega$  (which has no loops) and we want to determine the combinatorial tree type of  $f^{-1}(\omega)$ . Consider the edges  $\{e, f, g\}$  of any triangle in  $K_n$ ; we can find out whether  $e$  is maximum in this triangle as follows. Take a minimum spanning tree  $T$  containing  $e$ . Either  $T \setminus e \cup f$  or  $T \setminus e \cup g$  is a spanning tree; assume it is the first. If  $T \setminus e \cup f$  is a minimum spanning tree, then  $\omega(e) = \omega(f)$ , and  $e$  is maximum in the triangle. Otherwise  $\omega(e) < \omega(f)$  and  $e$  is not maximum in the triangle. Determining this information for each triangle tells us, for each triple of leaves, which one (if any) branched off first in the corresponding tree. It is easy to reconstruct the combinatorial type of the tree from this data, in the same way that one recovers an equidistant tree from its corresponding ultrametric [12, Theorem 7.2.5].  $\square$

The link of the origin in the coarse subdivision of  $\mathcal{T}_n$ , which we call  $T_n$ , is a simplicial complex which has appeared in many different contexts. It was first considered by Boardman [5], and also studied by Readdy [10], Robinson and Whitehouse [11], Sundaram [16], Trappmann and Ziegler [17], Vogtmann [18], and Wachs [19], among others. By Theorem 3.5, the link of the origin in the fine subdivision of  $\tilde{\mathcal{B}}(K_n)$  is the order complex of the partition lattice  $\Pi_n$ . We conclude the following result.

**Corollary 4.6.** *The order complex of the partition lattice  $\Pi_n$  is a subdivision of the complex  $T_n$ .*

This provides a new explanation of the known result [10, 11, 16, 17, 18, 19] that these two simplicial complexes are homotopy equivalent; namely, they have the homotopy type of a wedge of  $(n-1)!$   $(n-3)$ -dimensional spheres.

Let us now revisit the example of the last section. In Figure 4 we show the Bergman complex  $\mathcal{B}(K_4)$ , with some of the corresponding trees. We now know that this is a subdivision of  $T_4$ , the link of the origin in the space of phylogenetic trees with 4 leaves, which is the Petersen graph. The three extra vertices in the fine

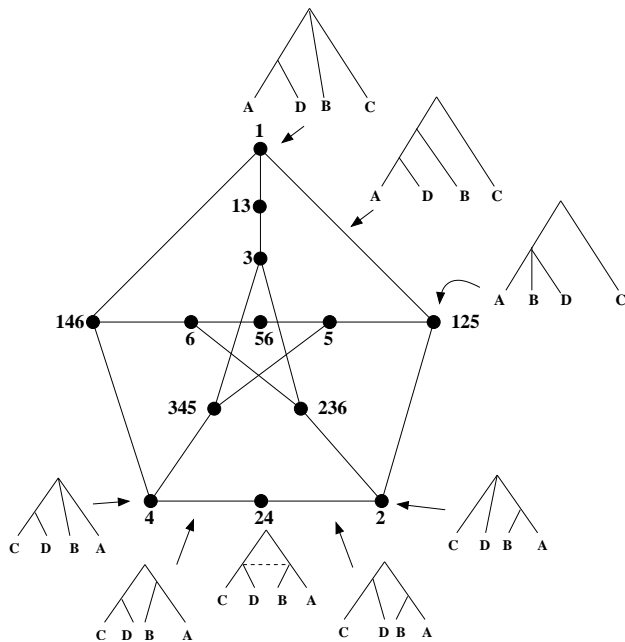

FIGURE 4. The fine subdivision of  $\mathcal{B}(K_4)$ .

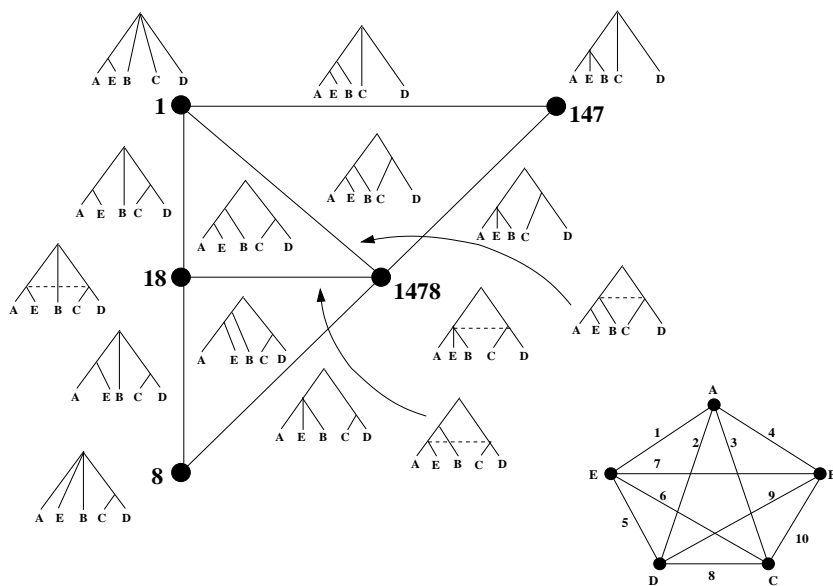

FIGURE 5. A piece of the fine subdivision of  $\mathcal{B}(K_5)$ .

subdivision are 13, 24 and 56. The tree corresponding to vertex 24 of the fine subdivision has the property that the vertex joining the leaves  $C$  and  $D$  is at the same height as the vertex joining the leaves  $A$  and  $B$ . This information is not captured by the combinatorial type of the tree; *i.e.*, by the coarse subdivision.



In Figure 5, we show a representative piece of the fine subdivision of the space of trees with 5 leaves, with  $K_5$  labeled as shown.

## 5. Acknowledgments

We would like to thank Bernd Sturmfels for suggesting to us the project of studying the Bergman complex of a matroid, and for many helpful conversations on this topic. We would also like to thank Lou Billera, Günter Ziegler, and an anonymous referee, for reading preliminary versions of this manuscript and helping us improve the presentation.

## 6. Appendix: Matroids

**Definition 6.1.** A *matroid*  $M$  on a finite ground set  $E$  is a collection of subsets  $\mathcal{I}$  such that:

- (1)  $\emptyset \in \mathcal{I}$
- (2) If  $I_1 \in \mathcal{I}$  and  $I_2 \subseteq I_1$  then  $I_2 \in \mathcal{I}$ .
- (3) If  $I_1, I_2 \in \mathcal{I}$  and  $|I_1| < |I_2|$  then there exists an element  $x \in I_2 - I_1$  such that  $I_1 \cup x \in \mathcal{I}$ .

Elements of  $\mathcal{I}$  are referred to as the *independent sets* of  $M$

For example, let  $V$  be a finite set of vectors in  $\mathbb{R}^n$ . Let  $\mathcal{I}$  be the collection of all linearly independent subsets of  $V$ . Then  $\mathcal{I}$  is the collection of independent sets of a matroid on the ground set  $V$ . This fundamental example motivates many concepts and results in matroid theory.

First we review some standard matroid concepts. A *basis* is a maximal independent set. A *circuit* is a minimal dependent set and we call a one element dependent set a *loop*.

**Definition 6.2.** The *rank* of a subset  $X \subset E$ ,  $r(X)$ , is the size of the largest independent set in  $X$ . A set  $X$  is a *flat* if for all elements  $e \in E - X$ ,  $r(X \cup e) > r(X)$ . The *closure*  $\overline{X}$  of a subset  $X$  of  $E$  is the minimal flat that contains it. The poset of flats ordered by containment is a lattice, which we call the *lattice of flats*,  $L_M$ .

**Definition 6.3.** The *order complex* of a finite poset  $P$  is the simplicial complex  $\Delta(P) = \{C \subset P \mid C \text{ is a chain of } P\}$ .

**Definition 6.4.** The *matroid polytope* of  $M$  is the polytope  $P_M$  in  $\mathbb{R}^E$  with vertex set  $\{e_{b_1} + \dots + e_{b_r} \mid \{b_1, \dots, b_r\} \text{ is a basis of } M\}$ , where  $e_i$  is the  $i$ -th unit vector.

**Definition 6.5.** For a subset  $T \subset E$ , the *restriction of  $M$  to  $T$* , or *deletion of  $E - T$  from  $M$* , is the matroid on the ground set  $T$ , whose rank function is  $r_{M|T}(X) = r_M(X)$  for  $X \subseteq T$ . This matroid is denoted  $M|T$  or  $M \setminus (E - T)$ .

**Definition 6.6.** For a subset  $T \subset E$ , the *contraction of  $T$  from  $M$*  is the matroid on the ground set  $E - T$ , whose rank function is  $r_{M/T}(X) = r_M(X \cup T) - r_M(T)$ . This matroid is denoted  $M/T$ .

**Definition 6.7.** Given two matroids  $M_1$  and  $M_2$  on disjoint sets  $E_1$  and  $E_2$ , there is a matroid  $M_1 \oplus M_2$  on the ground set  $E_1 \cup E_2$ , called the *direct sum* of  $M_1$  and  $M_2$ . Its bases are the sets of the form  $B_1 \cup B_2$ , where  $B_1$  and  $B_2$  are bases of  $M_1$  and  $M_2$  respectively. Its flats are the sets of the form  $F_1 \cup F_2$ , where  $F_1$  and  $F_2$  are flats of  $M_1$  and  $M_2$  respectively.

## References

- [1] G. Bergman. *The logarithmic limit-set of an algebraic variety*. Transactions of the American Mathematical Society, vol. 157, 459-469, 1971.
- [2] R. Bieri and J. Groves. *The geometry of the set of characters induced by valuations*. J. Reine Angew. Math., vol. 347, 168-195, 1984.
- [3] L. Billera, S. Holmes, and K. Vogtmann. *Geometry of the space of phylogenetic trees*. Advances in Applied Mathematics, vol. 27, 733-767, 2001.
- [4] A. Björner. *The homology and shellability of matroids and geometric lattices*. Matroid Applications. Encyclopedia of Mathematics and Its Applications, vol. 40. Cambridge University Press, Cambridge, 1992.
- [5] J. M. Boardman. *Homotopy structures and the language of trees*. Proc. Sympos. Pure Math., vol. 22, 37-58, 1971.
- [6] A. Borovik, I. Gelfand, and N. White. *Coxeter matroids*. Birkhauser, Boston, 2003.

- [7] M. Einsiedler, M. Kapranov, D. Lind, and T. Ward. *Non-archimedean amoebas*. Preprint, 2003.
- [8] D. Kozen. *The design and analysis of algorithms*. Lecture Notes in Computer Science, Springer-Verlag, 1991.
- [9] J. G. Oxley. *Matroid theory*. Oxford University Press, New York, 1992.
- [10] M. A. Readdy. *The pre-WDVV ring of physics and its topology*, preprint, 2002.
- [11] A. Robinson and S. Whitehouse. *The tree representation of  $\sigma_{n+1}$* . J. Pure Appl. Algebra, vol. 111, 245-253, 1996.
- [12] C. Semple and M. Steel. *Phylogenetics*. Oxford Lecture Series in Mathematics and Its Applications, Oxford University Press, 2003.
- [13] D. Speyer and B. Sturmfels. *The tropical Grassmannian*. Preprint, arXiv:math.AG/0304218.
- [14] R. P. Stanley. *Enumerative combinatorics, vol.1*. Cambridge University Press, New York, 1986.
- [15] B. Sturmfels. *Solving systems of polynomial equations*. CBMS Regional Conference Series in Mathematics, vol. 97. American Mathematical Society, Providence, RI, 2002.
- [16] S. Sundaram. *Homotopy of the non-modular partitions and the Whitehouse module*. J. Algebraic Combinatorics, vol. 9, 251-269, 1999.
- [17] H. Trappmann and G. M. Ziegler. *Shellability of complexes of trees*. Journal of Combinatorial Theory, Series A, vol. 82, 168-178, 1998.
- [18] K. Vogtmann. *Local structure of some  $OUT(F_n)$ -complexes*. Proc. Edinburgh Math. Soc. (2), vol. 33, 367-379, 1990.
- [19] M. Wachs, personal communication, 2003.

MATHEMATICAL SCIENCES RESEARCH INSTITUTE, BERKELEY, CA, 94709

*E-mail address:* federico@msri.org

*URL:* <http://www.msri.org/~federico>

MATHEMATICAL SCIENCES RESEARCH INSTITUTE, BERKELEY, CA, 94709

*Current address:* 4114 Upson Hall, Cornell University, Ithaca, NY, 14853

*E-mail address:* cjk11@cornell.edu

*URL:* <http://www.cs.cornell.edu/~cjk>



## On a Conjecture Concerning Littlewood-Richardson Coefficients

François Bergeron, Riccardo Biagioli, and Mercedes Rosas

**Abstract.** *We prove that a conjecture of Fomin, Fulton, Li, and Poon, associated to ordered pairs of partitions, holds for many infinite families of such pairs. We also show that the generic bounded height case can be reduced to only checking that the conjecture holds for a finite number of pairs, for any given height. Moreover, we propose a natural generalization of the conjecture to the case of skew shapes.*

**Résumé.** *Nous démontrons qu'une conjecture de Fomin, Fulton, Li et Poon, associée aux couples de partages, se vérifie pour plusieurs classes infinies de tels couples. Nous montrons aussi que le cas générique, pour des partages de hauteurs bornés, se réduit à la vérification de la conjecture pour un nombre fini de couples, et ce pour chaque hauteur. De plus, nous présentons une généralisation naturelle de la conjecture au cas des couples de partages gauches.*

### 1. Introduction

In [1], Fomin, Fulton, Li, and Poon state a very interesting conjecture concerning the Schur-positivity of special differences of products of Schur functions of the form

$$s_{\mu^*} s_{\nu^*} - s_{\mu} s_{\nu},$$

where  $\mu^*$  and  $\nu^*$  are partitions constructed from an ordered pair of partitions  $\mu$  and  $\nu$  through a seemingly strange procedure. In our presentation, their transformation  $(\mu, \nu) \mapsto (\mu^*, \nu^*)$  on ordered pairs of partitions, will rather be denoted

$$(1.1) \quad (\mu, \nu) \longmapsto (\mu, \nu)^* = (\lambda(\mu, \nu), \rho(\mu, \nu))$$

and will still be called the  $*$ -operation. As we shall see, this change of notation is essential in order to simplify the presentation of the many nice combinatorial properties of this operation. On the other hand, it makes clear that both entries,  $\lambda$  and  $\rho$  of the image  $(\mu, \nu)^*$  of  $(\mu, \nu)$ , depend on  $\mu$  and  $\nu$ .

With this slight change of notation, the original definition of the  $*$ -operation is as follows. Let  $\mu = (\mu_1, \mu_2, \dots, \mu_n)$  and  $\nu = (\nu_1, \nu_2, \dots, \nu_n)$  two partitions with the same number of parts, allowing zero parts. From these, two new partitions

$$\lambda(\mu, \nu) = (\lambda_1, \lambda_2, \dots, \lambda_n) \quad \text{and} \quad \rho(\mu, \nu) = (\rho_1, \rho_2, \dots, \rho_n)$$

are constructed as follows

$$(1.2) \quad \begin{aligned} \lambda_k &:= \mu_k - k + \#\{j \mid 1 \leq j \leq n, \nu_j - j \geq \mu_k - k\}; \\ \rho_j &:= \nu_j - j + 1 + \#\{k \mid 1 \leq k \leq n, \mu_k - k > \nu_j - j\}. \end{aligned}$$

Although this definition does not make it immediately clear, both  $\lambda(\mu, \nu)$  and  $\rho(\mu, \nu)$  are truly partitions, and they are such that

$$|\lambda(\mu, \nu)| + |\rho(\mu, \nu)| = |\mu| + |\nu|,$$

where as usual  $|\mu|$  denotes the sum of the parts of  $\mu$ .

Recall that the product of two Schur functions can always be expanded as a linear combination

$$s_\mu s_\nu = \sum_{\theta} c_{\mu\nu}^{\theta} s_{\theta},$$

of Schur functions indexed by partitions  $\theta$  of the integer  $n = |\mu| + |\nu|$ , since these Schur functions constitute a linear basis of the homogeneous symmetric functions of degree  $n$ . It is a particularly nice feature of this expansion that the coefficients  $c_{\mu\nu}^{\theta}$  are always non-negative integers. They are called the *Littlewood-Richardson coefficients*. More generally, we say that a symmetric function is *Schur positive* whenever the coefficients in its expansion, in the Schur function basis, are all non-negative integers. For more details on symmetric function theory see Macdonald's classical book [2], whose notations we will mostly follow. We can then state the following:

**Conjecture 1.1** (Fomin-Fulton-Li-Poon). *For any pair of partitions  $(\mu, \nu)$ , if*

$$(\mu, \nu)^* = (\lambda, \rho),$$

*then the symmetric function*

$$(1.3) \quad s_{\lambda} s_{\rho} - s_{\mu} s_{\nu}$$

*is Schur-positive.*

In other words, this says that  $c_{\mu\nu}^{\theta} \leq c_{\lambda\rho}^{\theta}$ , for all  $\theta$  such that  $s_{\theta}$  appears in the expansion of  $s_{\mu} s_{\nu}$ .

For an example of one of the simplest case of the  $*$ -operation, let  $\mu = (a)$  and  $\nu = (b)$ , with  $a > b$ , be two one-part partitions. In this case, we get

$$((a), (b))^* = (a-1, b+1),$$

so that Conjecture 1.1 corresponds exactly to an instance of the classical Jacobi-Trudi identity:

$$\begin{aligned} s_{a-1} s_{b+1} - s_a s_b &= \det \begin{pmatrix} s_{a-1} & s_a \\ s_b & s_{b+1} \end{pmatrix} \\ &= s_{a-1, b+1}. \end{aligned}$$

In this article we give a new recursive combinatorial description of the  $*$ -operation. This recursive description allows us to prove many instances of Conjecture 1.1 and to show that it reduces to checking a finite number of instances for any fixed  $\nu$ , if we bound the number of parts of  $\mu$ . Moreover we show how to naturally generalize the conjecture to pairs of skew partitions.

## 2. Combinatorial description of the $*$ -operation.

We first derive some nice combinatorial properties of the transformation “ $*$ ”. To help in the presentation of these properties, let us introduce some further notations. We often identify a partition with its (Ferrers) diagram. Diagrams are drawn here using the “French” convention of ordering parts in decreasing order from bottom to top.

We write  $\mu = \overrightarrow{\alpha}^{\ell}$ , if the partition  $\mu$  is obtained from the partition  $\alpha$  by adding one cell in line  $\ell$ ; and  $\mu = \alpha \uparrow_k$ , if  $\mu$  is obtained from  $\alpha$  by adding one cell in column  $k$ . In other words,  $\mu = \overrightarrow{\alpha}^i$  means that  $\mu_i = \alpha_i$  for all  $i \neq \ell$ , and  $\mu_{\ell} = \alpha_{\ell} + 1$ . This is illustrated in Figure 1 in term of diagrams.



FIGURE 1.

Observe that,

$$\begin{aligned} \mu = \overrightarrow{\alpha}^i & \quad \text{iff} \quad \mu' = \overrightarrow{\alpha'}^{\mu_i} \\ & \quad \text{iff} \quad \mu = \alpha \uparrow_{\mu_i} \\ & \quad \text{iff} \quad \mu' = \alpha' \uparrow_i \end{aligned}$$

We can now state our recursive description of the  $*$ -operation.

**Proposition 2.1** (Recursive formula). *For any partitions  $\alpha$  and  $\nu$ , if  $(\lambda, \rho) = (\alpha, \nu)^*$ , then we have*

$$(2.1) \quad (\overrightarrow{\alpha}^i, \nu)^* = \begin{cases} (\lambda, \overrightarrow{\rho}^j) & \text{where } j \text{ is such that } \nu_j - j = \alpha_i - i, \text{ if any,} \\ (\overrightarrow{\lambda}^i, \rho) & \text{otherwise.} \end{cases}$$

Moreover, when in the first case, we have  $\overrightarrow{\rho}^j = \rho \uparrow_{\mu_i}$ . In a similar manner, for given  $\mu$  and  $\beta$ , if  $(\lambda, \rho) = (\mu, \beta)^*$ , then

$$(2.2) \quad (\mu, \overrightarrow{\beta}^i)^* = \begin{cases} (\overrightarrow{\lambda}^j, \rho) & \text{where } j \text{ is such that } \mu_j - j = \nu_i - i, \text{ if any,} \\ (\lambda, \overrightarrow{\rho}^i) & \text{otherwise,} \end{cases}$$

and, when in the first case, we have  $\overrightarrow{\lambda}^j = \lambda \uparrow_{\nu_i}$ .

We can clearly use Proposition 2.1 to recursively compute  $\lambda(\mu, \nu)$  and  $\rho(\mu, \nu)$ . Examples are given in Section 4. The computation of the  $*$ -operation can be simplified in view of the following property of the  $*$ -operation. For any pair of partitions  $(\mu, \nu)$ , we have

$$(2.3) \quad (\mu, \nu)^* = (\lambda, \rho) \quad \text{iff} \quad (\nu', \mu')^* = (\lambda', \rho'),$$

where, as usual,  $\mu'$  stands for the conjugate of  $\mu$ . Using the fact that the involution  $\omega$  (which is the linear operator that maps  $s_\mu$  to  $s_{\mu'}$ ) is multiplicative, it easily follows that

**Proposition 2.2.** *Conjecture 1.1 holds for the pair  $(\mu, \nu)$  if and only if it holds for the pair  $(\nu', \mu')$ .*

In practice, there are many ways to describe the  $*$ -operation recursively, since we can freely choose how to make partitions grow. It is sometimes convenient to start from the pair  $(0, \nu)$ , whose image under the  $*$ -operation has a simple description.

**Lemma 2.3.** *Let  $\nu$  be any partition. Then*

$$\begin{aligned} \rho(0, \nu) &= (\nu_1, \nu_2 - 1, \dots, \nu_k - (k - 1)) \\ \lambda'(0, \nu) &= (\nu'_1 - 1, \nu'_2 - 2, \dots, \nu'_k - k) \end{aligned}$$

where  $k = \max\{i : \nu_i - (i - 1) \geq 1\}$ .

We will sometimes denote respectively  $\bar{\nu}$  and  $\underline{\nu}$  the partitions  $\lambda(0, \nu)$  and  $\rho(0, \nu)$ . For example if  $\nu = (8, 6, 6, 5, 5, 4, 4, 2, 1)$ , then

$$\bar{\nu} = (4, 4, 4, 3, 2, 2, 1, 1) \quad \text{and} \quad \underline{\nu} = (8, 5, 4, 2, 1)$$

as is illustrated in Figure 2. In Section 4 we elaborate on the various ways that Proposition 2.1 can be used to compute the  $*$ -operation. This gives rise to a  $*$ -operation on pairs of Young tableaux.

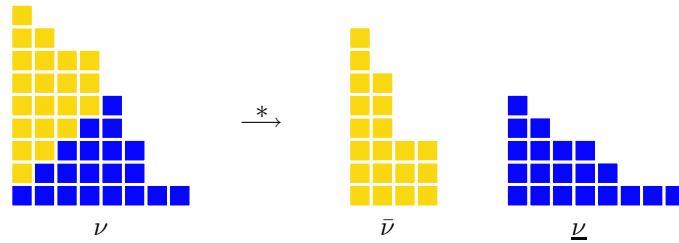

FIGURE 2.

Figure 3 illustrates the effect of the  $*$ -operation on some pairs of the form  $((n), \nu)$ .

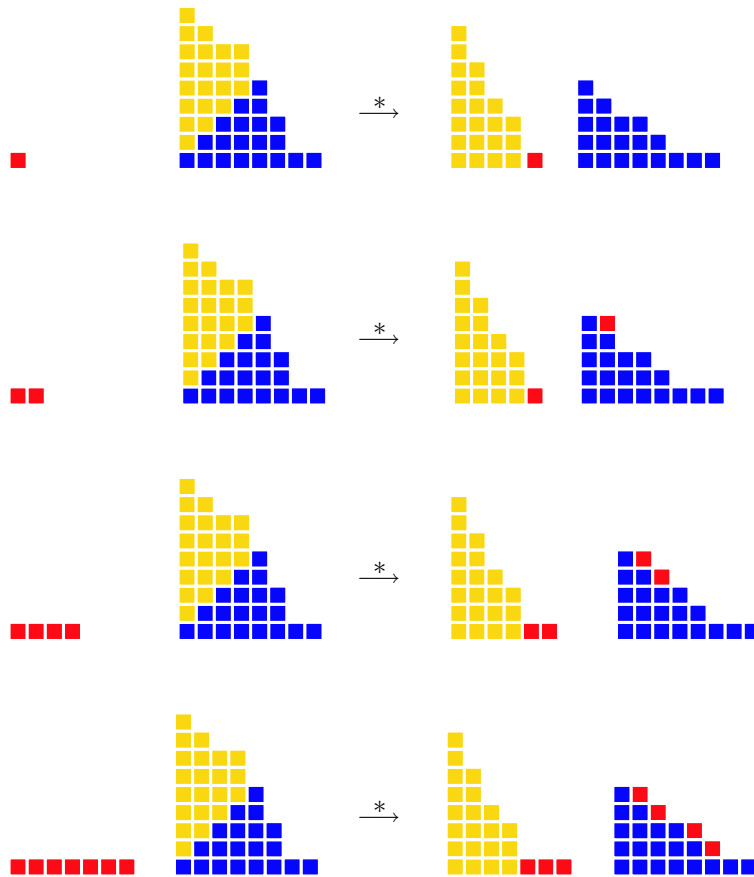

FIGURE 3.

Given partitions  $\mu$  and  $\nu$ , define the partition  $\mu + \nu$  by

$$(\mu + \nu)_i := \mu_i + \nu_i.$$

and set

$$\mu \cup \nu := (\mu' + \nu)'$$

For example, if  $\mu = (3, 3, 2, 2, 1)$  and  $\nu = (5, 3, 1, 0, 0)$ , then  $\mu \cup \nu = (5, 3, 3, 3, 2, 2, 1, 1)$  and  $\mu + \nu = (8, 6, 3, 2, 1)$ . As usual, for  $\mu$  and  $\nu$  two partitions of  $n$ ,  $\mu$  is said to be *dominated* by  $\nu$ , in formula  $\mu \preceq \nu$ , if for all  $k \geq 1$ :

$$\mu_1 + \mu_2 + \cdots + \mu_k \leq \nu_1 + \nu_2 + \cdots + \nu_k.$$

Another remarkable property of the  $*$ -operation is that its image behaves nicely under the dominance order. More precisely,

**Lemma 2.4.** *For any pair of partitions  $(\mu, \nu)$ , if  $(\lambda, \rho) = (\mu, \nu)^*$ , then we have*

$$(2.4) \quad \mu \cup \nu \succeq \lambda \cup \rho, \quad \text{and equivalently}$$

$$(2.5) \quad \mu + \nu \preceq \lambda + \rho.$$

Observe that when  $s_\theta$  appears in  $s_\mu s_\nu$  with a nonzero coefficient, then

$$\mu \cup \nu \preceq \theta \preceq \mu + \nu,$$

thus (2.4) and (2.5) imply that

$$\lambda \cup \rho \preceq \theta \preceq \lambda + \rho,$$

which is compatible with Conjecture 1.1.

Lemma 2.4 immediately implies a statement very similar to that of Conjecture 1.1.

**Proposition 2.5.** *For any pair of partitions  $(\mu, \nu)$ , if  $(\lambda, \rho) = (\mu, \nu)^*$ , then*

$$h_\lambda h_\rho - h_\mu h_\nu$$

*is Schur-positive.*

Recalling that  $h_\mu h_\nu = h_{\mu \cup \nu}$ , this follows from the fact that a difference of two homogeneous symmetric functions  $h_\alpha - h_\beta$  is Schur-positive, if and only if  $\alpha \preceq \beta$  (see [4, Chapter 2]). A clear link between this proposition and Conjecture 1.1 is established through the classical identity:

$$h_\alpha = s_\alpha + \sum_{\beta \succeq \alpha} K_{\beta\alpha} s_\beta,$$

where as usual  $K_{\beta\alpha}$ , the *Kostka* numbers, count the number of semi-standard tableaux of shape  $\beta$  and content  $\alpha$ .

The following results, shows that the  $*$ -operation is also compatible with “inclusion” of partitions. Here, we say that  $\alpha$  is *included* in  $\mu$ , if the diagram of  $\alpha$  is included in the diagram of  $\mu$ . We will simply write

$$(\alpha, \beta) \subseteq (\mu, \nu), \quad \text{whenever} \quad \alpha \subseteq \mu \quad \text{and} \quad \beta \subseteq \nu.$$

**Lemma 2.6.** *Let  $\alpha, \beta, \mu$  and  $\nu$  be partitions such that  $(\alpha, \beta) \subseteq (\mu, \nu)$ . Then  $\lambda(\alpha, \beta) \subseteq \lambda(\mu, \nu)$  and  $\rho(\alpha, \beta) \subseteq \rho(\mu, \nu)$ .*

An immediate, but interesting, consequence of this lemma is the following observation.

**Observation 2.7.** Let  $(\alpha, \beta)$  and  $(\gamma, \delta)$  be two fixed points such that  $(\alpha, \beta) \subseteq (\gamma, \delta)$ . Writing simply  $\lambda$  for  $\lambda(\mu, \nu)$  and  $\rho$  for  $\rho(\mu, \nu)$ , we see (using Lemma 2.6) that

$$(\alpha, \beta) \subseteq (\mu, \nu) \subseteq (\gamma, \delta),$$

implies

$$(\alpha, \beta) \subseteq (\lambda, \rho) \subseteq (\gamma, \delta).$$

As is underlined in [1], a pair of partitions  $(\alpha, \beta)$  is a fixed point of the  $*$ -operation if and only if

$$(2.6) \quad \beta_1 \geq \alpha_1 \geq \beta_2 \geq \alpha_2 \geq \cdots \geq \beta_n \geq \alpha_n.$$

Let us underline here that, for any  $(\mu, \nu)$ , it is easy to characterize the “largest” (resp. “smallest”) fixed point contained in (resp. containing) the pair  $(\mu, \nu)$ . We will see below how this observation can be used to link properties of  $\lambda$  and  $\rho$  to properties of  $\mu$  and  $\nu$ . Recall that an *horizontal strip* is a skew shape  $\mu/\alpha$  with

no two squares in the same column, and that a *ribbon* is a connected skew shape with no  $2 \times 2$  squares (see [5, Chapter 7], for more details). If we drop the condition of being connected in this last definition, we say that we have a *weak ribbon*.

Another striking consequence of Lemma 2.6 is that it allows a natural extension of the  $*$ -operation to skew partitions. Denoting  $(\mu, \nu)/(\alpha, \beta)$  the pair of skew shapes  $(\mu/\alpha, \nu/\beta)$ , we can simply define

$$(2.7) \quad (\mu/\alpha, \nu/\beta)^* := (\mu, \nu)^*/(\alpha, \beta)^*.$$

In other words, we have

$$(2.8) \quad \lambda(\mu/\alpha, \nu/\beta) := \lambda(\mu, \nu)/\lambda(\alpha, \beta),$$

and

$$(2.9) \quad \rho(\mu/\alpha, \nu/\beta) := \rho(\mu, \nu)/\rho(\alpha, \beta).$$

The  $*$ -operation, or its extension as above, preserves (among others) the following families of pairs of (skew) shapes.

**Proposition 2.8.** *The “ $*$ ” -operation preserves the families of*

- (1) *pairs of hooks;*
- (2) *pairs of two-rows partitions;*
- (3) *pairs of horizontal strips;*
- (4) *pairs of weak ribbon.*

Note that (1) and (2) follow directly from observation 2.7, and that the statements (3) and (4) are made possible in view of our extension of the  $*$ -operation.



FIGURE 4. The effect of the  $*$ -operation on hooks.

Results outlined in the sequel, and extensive computer experimentations suggests that we have the following extension of Conjecture 1.1.

**Conjecture 2.9.** *For any skew partitions  $\mu/\alpha$  and  $\nu/\beta$ , if*

$$(\lambda, \rho) = (\mu/\alpha, \nu/\beta)^*,$$

*then the symmetric function*

$$(2.10) \quad s_\lambda s_\rho - s_{\mu/\alpha} s_{\nu/\beta}$$

*is Schur-positive.*

This has yet to be understood in geometrical terms. On the other hand, it is clear that Proposition 2.2 extends to skew partitions. Our last combinatorial observation concerning the  $*$ -operation is the following. Let  $\tau$  and  $\nu$  be two fixed partitions, and consider all possible  $\mu$ 's such that  $\rho(\mu, \nu) = \tau$ . We claim that there is a minimal such  $\mu$ , if any, and we denote it  $\theta(\tau, \nu)$ . More precisely, we easily show that

**Proposition 2.10.** *Given partitions  $\tau$  and  $\nu$ , for any  $\mu$  such that  $\rho(\mu, \nu) = \tau$ , then*

$$\theta(\tau, \nu) \subseteq \mu.$$



Furthermore,  $\theta = \theta(\tau, \nu)$  is exactly the partition

$$\theta = \rho_1^{b_1} \rho_2^{b_2 - b_1} \rho_3^{b_3 - b_2} \dots,$$

with  $b_j = \rho_j - \nu_j + j - 1$ .

### 3. Main results

In this section we state our results concerning the validity of Conjecture 1.1 for certain families of pairs, as well as its reduction to a finite number of tests for other families. We show the following.

**Theorem 3.1.** *Conjecture 1.1 (or 2.9) holds*

- (1) *For any pair  $(\mu, \nu)$  of hook shapes.*
- (2) *For pairs of two-line and two-column partitions.*
- (3) *For skew pairs the form  $(\mu/\alpha, \nu/\beta)$ , with all of  $\mu, \nu, \alpha$  and  $\beta$  are hooks.*
- (4) *For skew pairs of the form  $(0, \nu/\beta)$ , with  $\nu/\beta$  a weak ribbon.*

Other families for which we have partial results correspond to Stembridge's (see [6]) classification of all multiplicity-free products of Schur functions. More precisely, these are all products of two Schur functions with Schur function expansion having no coefficient larger than 1. Thus, to show Conjecture 1.1 in these cases, we need only show that the coefficient  $c_{\lambda\rho}^\theta$  of  $s_\theta$  in the product of  $s_\lambda$  and  $s_\rho$  is nonzero, whenever  $c_{\mu\nu}^\theta = 1$ .

Stembridge uses the following notions for his presentation. A *rectangle* is a partition with at most one part size, i.e., empty, or of the form  $(c^r)$  for suitable  $c, r > 0$ ; a *fat hook* is a partition with exactly two parts sizes, i.e., of the form  $(b^r c^s)$  for suitable  $b > c > 0$ ; and a *near-rectangle* is a fat hook such that it is possible to obtain a rectangle from it by deleting a single row or column. He shows that the product  $s_\mu s_\nu$  is multiplicity-free if and only if

- (a)  $\mu$  or  $\nu$  is a one-line rectangle, or
- (b)  $\mu$  is a two-line rectangle and  $\nu$  is a fat hook or vice-versa, or
- (c)  $\mu$  is rectangle and  $\nu$  is a near rectangle or vice-versa, or
- (d)  $\mu$  and  $\nu$  are both rectangles.

Although we currently have proofs of the conjecture for cases (a) and (d) of Stembridge's pairs, proofs for cases (b) and (c) are still in the process of being completed. Since all these share a common approach, we have decide to postpone their presentation to an upcoming paper.

On another register, a careful study of the recursive construction of  $\lambda(\mu, \nu)$  and  $\rho(\mu, \nu)$  shows that, in a sense, Conjecture 1.1 follows, under some conditions, from a finite number of cases when  $\nu$  is fixed and  $\mu$  becomes large.

More precisely, we obtain the result below. As usual, the number of nonzero parts of  $\mu$  is denoted by  $\ell(\mu)$  and called the *height* of  $\mu$ .

**Theorem 3.2.** *For any positive integer  $p$ , let  $\nu$  be a fixed partition with at most  $p$  parts, i.e.  $\ell(\nu) \leq p$ . Then, the validity of Conjecture 1.1 for the infinite set of all pairs  $(\mu, \nu)$ , with  $\ell(\mu) \leq p$ , reduces to checking the validity of the conjecture for the finite set of pairs  $(\alpha, \nu)$ , with  $\alpha$  having at most  $p$  parts, and largest part bounded as follows*

$$(3.1) \quad \alpha_1 \leq p(\nu_1 + p).$$

Theorem 3.2 can also be generalized in a straightforward manner to the set of skew shapes pairs  $(\mu/\alpha, \nu/\beta)$  of bounded height, with  $\nu$  and  $\alpha$  fixed.

#### 4. Final remarks

To study more consequences of the properties of “\*”, we consider the *double Young lattice*,  $\mathcal{D}$ , which is just the direct product of two copies of the usual Young lattice. This poset is naturally graded by  $(\mu, \nu) \mapsto |\mu| + |\nu|$ . A *standard (tableau) pair of shape*  $(\mu, \nu)$  is a maximal chain in this graded poset that starts at  $(0, 0)$ , the pair of empty partitions, and ends at  $(\mu, \nu)$ . For example, we have

$$(4.1) \quad (0, 0) \subseteq (0, 1) \subseteq (0, 2) \subseteq (1, 2) \subseteq (11, 2) \subseteq (21, 2) \subseteq (21, 3)$$

Clearly, as in the usual case, such a chain can be identified with a pair  $(t, r)$  of standard tableaux, of respective shapes  $\mu$  and  $\nu$ , with non-repeated entries from the the set  $\{1, 2, \dots, n\}$ ,  $n = |\mu| + |\nu|$ . The number  $f_{(\mu, \nu)}$  of standard pairs of shape  $(\mu, \nu)$  is thus

$$(4.2) \quad f_{(\mu, \nu)} = \binom{|\mu| + |\nu|}{|\mu|} f_{\mu} f_{\nu}$$

where  $f_{\mu}$  and  $f_{\nu}$  are both given by the usual hook formula.

In terms of tableaux, the standard pair (4.1) corresponds to:

$$\left( \begin{array}{|c|c|} \hline 4 & \\ \hline 3 & 5 \\ \hline \end{array} , \begin{array}{|c|c|c|} \hline 1 & 2 & 6 \\ \hline \end{array} \right).$$

The double Young lattice occurs naturally in the study of representations of the hyperoctahedral groups. This suggests that there might be a link between that subject and the study of properties of the transformation “\*”. A *semi-standard pair* is a chain

$$(0, 0) = \pi_0 \subseteq \pi_1 \subseteq \dots \subseteq \pi_k = (\mu, \nu)$$

in  $\mathcal{D}$ , such that  $\pi_{j+1}/\pi_j$  is an horizontal strip pair for each  $1 \leq j \leq k - 1$ . For example, the pair of semi-standard tableaux

$$\left( \begin{array}{|c|c|c|} \hline 3 & & \\ \hline 2 & 3 & 3 \\ \hline \end{array} , \begin{array}{|c|c|c|} \hline 2 & 3 & \\ \hline 1 & 1 & 3 \\ \hline \end{array} \right),$$

corresponds to the path

$$(0, 0) \subseteq (0, 2) \subseteq (1, 21) \subseteq (31, 32).$$

**Lemma 4.1.** *The function  $*$  :  $\mathcal{D} \rightarrow \mathcal{D}$  is a level preserving increasing transformation that preserves both standard and semi-standard pairs.*

For example, for the standard pair

$$\left( \begin{array}{|c|c|c|c|c|} \hline 26 & & & & \\ \hline 22 & 23 & 24 & & \\ \hline 16 & 17 & 18 & 19 & 20 \\ \hline 9 & 10 & 11 & 12 & 13 \\ \hline \end{array} , \begin{array}{|c|c|c|c|c|c|c|c|} \hline 25 & & & & & & & \\ \hline 21 & & & & & & & \\ \hline 14 & 15 & & & & & & \\ \hline 1 & 2 & 3 & 4 & 5 & 6 & 7 & 8 \\ \hline \end{array} \right)$$

the corresponding result is

$$\left( \begin{array}{|c|c|c|c|c|} \hline 26 & & & & \\ \hline 22 & 24 & & & \\ \hline 16 & 17 & 19 & 20 & \\ \hline 9 & 10 & 11 & 12 & 13 \\ \hline \end{array} , \begin{array}{|c|c|c|c|c|c|c|c|} \hline 25 & & & & & & & \\ \hline 21 & 23 & & & & & & \\ \hline 14 & 15 & 18 & & & & & \\ \hline 1 & 2 & 3 & 4 & 5 & 6 & 7 & 8 \\ \hline \end{array} \right).$$

Observe that, in this example, the original right tableau is contained in the resulting right tableau. This is heavily dependent on the very particular labeling that has been chosen here in the original pair. Up to

a careful choice of labeling this phenomenon becomes a frequent (but not systematic) occurrence. Fixed points, for standard pairs, are easily characterized as follows.

**Lemma 4.2.** *A standard pair  $(t, r)$ , of shape  $(\mu, \nu)$ , is fixed point of the  $*$ -operation, if and only if  $(\mu, \nu)$  is fixed, and the tableau, obtained by alternating rows of  $r$  and rows of  $t$ , is standard.*

We believe that to get a better understanding of the  $*$ -operation, the study of its effect on tableaux and semi-standard tableaux will be crucial. For instance this should lead to a proof of a “monomial” versions of Conjectures 1.1 and 2.9. More precisely, recall that the expansion of any Schur function in the basis of monomial symmetric functions involves only positive integers. It would thus follow from the Conjectures that the expansion of the difference of products considered have positive integer coefficients when expanded in term of monomial symmetric function. In particular, using definition (4.2), one should have

$$(4.3) \quad f_{(\lambda, \rho)} \geq f_{(\mu, \nu)}.$$

whenever  $(\lambda, \rho) = (\mu, \nu)^*$ . An independent proof of these facts would clearly lend support to the Conjectures.

## 5. Acknowledgment

The authors would like to thank Peter McNamara [3] for his contribution regarding the proof of Lemma 2.4

## References

- [1] S. FOMIN, W. FULTON, CHI-KWONG LI, AND YIU-TUNG POON, *Eigenvalues, Singular Values, and Littlewood-Richardson Coefficients*, Amer. J. Math., to appear.
- [2] I.G. MACDONALD, *Symmetric functions and Hall polynomials. Second edition*, Oxford University Press, New York, 1995.
- [3] P. MCNAMARA, *Personal communication*.
- [4] B.E. SAGAN, *The Symmetric Group, Representations, Combinatorial Algorithms, and Symmetric Functions*, GTM 203, Springer, 2000.
- [5] R.P. STANLEY, *Enumerative Combinatorics, Volume 2*, Cambridge University Press, 1999.
- [6] J.R. STEMBRIDGE, *Multiplicity-free products of Schur functions*, Ann. Comb. 5 (2001), no. 2, 113–121.

(F. Bergeron) DÉPARTEMENT DE MATHÉMATIQUES, UNIVERSITÉ DU QUÉBEC À MONTRÉAL, MONTRÉAL, QUÉBEC, H3C 3P8, CANADA

*E-mail address:* [bergeron.francois@uqam.ca](mailto:bergeron.francois@uqam.ca)

*URL:* <http://bergeron.math.uqam.ca>

(R. Biagioli, M. Rosas) LACIM, UNIVERSITÉ DU QUÉBEC À MONTRÉAL, MONTRÉAL, QUÉBEC, H3C 3P8, CANADA

*E-mail address:* [biagioli@math.uqam.ca](mailto:biagioli@math.uqam.ca), [rosas@math.uqam.ca](mailto:rosas@math.uqam.ca)

*URL:* <http://www.lacim.uqam.ca/~biagioli>, <http://www.lacim.uqam.ca/~rosas>





## A Four-Parameter Partition Identity

Cilanne E. Boulet

**Abstract.** *We present a new partition identity and give a combinatorial proof of our result. This generalizes a result of Andrews' in which he considers the generating function for partitions with respect to size, number of odd parts, and number of parts of the conjugate.*

**Résumé.** *Nous présentons une nouvelle identité sur les partitions ainsi qu'une démonstration combinatoire de notre résultat. Ceci généralise un résultat d'Andrews au sujet de la série génératrice des partitions relative à trois statistiques : la somme des parts, le nombre de parts impaires et le nombre de parts impaires de la partition conjuguée.*

### 1. Introduction

In [A], Andrews considers partitions with respect to size, number of odd parts, and number of odd parts of the conjugate. He derives the following generating function

$$(1.1) \quad \sum_{\lambda \in \text{Par}} r^{\theta(\lambda)} s^{\theta(\lambda')} q^{|\lambda|} = \prod_{j=1}^{\infty} \frac{(1 + rsq^{2j-1})}{(1 - q^{4j})(1 - r^2q^{4j-2})(1 - s^2q^{4j-2})}$$

where Par denotes the set of all partitions,  $|\lambda|$  denotes the size (sum of the parts) of  $\lambda$ ,  $\theta(\lambda)$  denotes the number of odd parts in the partition  $\lambda$ , and  $\theta(\lambda')$  denotes the number of odd parts in the conjugate of  $\lambda$ . Combinatorial proofs of Andrews' result have also been found by Sills in [Si] and by Yee in [Y].

We generalize this result and outline a combinatorial proof of our generalization. This gives a simpler combinatorial proof of (1.1) than the ones found in [Si] and [Y].

### 2. Main Result

Let  $\lambda = (\lambda_1, \lambda_2, \dots)$  be a partition of  $n$ , denoted  $\lambda \vdash n$ . Consider the following weight functions on the set of all partitions:

$$\begin{aligned} \alpha(\lambda) &= \sum [\lambda_{2i-1}/2] \\ \beta(\lambda) &= \sum [\lambda_{2i-1}/2] \\ \gamma(\lambda) &= \sum [\lambda_{2i}/2] \\ \delta(\lambda) &= \sum [\lambda_{2i}/2]. \end{aligned}$$

---

1991 *Mathematics Subject Classification.* Primary 05A17; Secondary 11P81.

*Key words and phrases.* partitions, bijective proof, partition identity.

The author was supported in part by NSERC.

Also, let  $a, b, c, d$  be (commuting) indeterminants, and define

$$w(\lambda) = a^{\alpha(\lambda)} b^{\beta(\lambda)} c^{\gamma(\lambda)} d^{\delta(\lambda)}.$$

For instance, if  $\lambda = (5, 4, 4, 3, 2)$  then  $\alpha(\lambda)$  is the number of  $a$ 's in the following diagram for  $\lambda$ ,  $\beta(\lambda)$  is the number of  $b$ 's in the diagram,  $\gamma(\lambda)$  is the number of  $c$ 's in the diagram, and  $\delta(\lambda)$  is the number of  $d$ 's in the diagram. Moreover,  $w(\lambda)$  is the product of the entries of the diagram.

$$\begin{array}{ccccc} a & b & a & b & a \\ c & d & c & d & \\ a & b & a & b & \\ c & d & c & & \\ a & b & & & \end{array}$$

These weights were first introduced by Stanley in [St].

Let  $\Phi(a, b, c, d) = \sum w(\lambda)$ , where the sum is over all partitions  $\lambda$ , and let  $\Psi(a, b, c, d) = \sum w(\lambda)$ , where the sum is over all partitions  $\lambda$  with distinct parts. We obtain the following product formulas for  $\Phi(a, b, c, d)$  and  $\Psi(a, b, c, d)$ :

**Theorem 2.1.**

$$\Phi(a, b, c, d) = \prod_{j=1}^{\infty} \frac{(1 + a^j b^{j-1} c^{j-1} d^{j-1})(1 + a^j b^j c^j d^{j-1})}{(1 - a^j b^j c^j d^j)(1 - a^j b^j c^{j-1} d^{j-1})(1 - a^j b^{j-1} c^j d^{j-1})}$$

**Corollary 2.2.**

$$\Psi(a, b, c, d) = \prod_{j=1}^{\infty} \frac{(1 + a^j b^{j-1} c^{j-1} d^{j-1})(1 + a^j b^j c^j d^{j-1})}{(1 - a^j b^j c^{j-1} d^{j-1})}$$

If we transform  $\Phi(a, b, c, d)$  by sending  $a \mapsto rsq$ ,  $b \mapsto r^{-1}sq$ ,  $c \mapsto rs^{-1}q$ , and  $d \mapsto r^{-1}s^{-1}q$ , a straightforward computation gives Andrews' result (1.1).

Our main result is a generalization of Theorem 2.1 and Corollary 2.2. It is the corresponding product formula in the case where we restrict the the parts to some congruence class (mod  $k$ ) and we restrict the number of times those parts can occur. Let  $R$  be a subset of positive integers congruent to  $i \pmod{k}$  and let  $\rho$  be a map from  $R$  to the even positive integers. Let  $\text{Par}(i, k; R, \rho)$  be the set of all partitions with parts congruent to  $i \pmod{k}$  such that if  $r \in R$ , then  $r$  appears as a part less than  $\rho(r)$  times. Let  $\Phi_{i,k;R,\rho}(a, b, c, d) = \sum_{\lambda} w(\lambda)$  where the sum is over all partitions in  $\text{Par}(i, k; R, \rho)$ .

For example,  $\text{Par}(1, 1; \emptyset, \rho)$  is  $\text{Par}$ , the set of all partitions. Also, if we let  $R$  be the set of all positive integers and  $\rho$  map every positive integer to 2, then  $\text{Par}(1, 1; R, \rho)$  is the set of all partitions with distinct parts. These are the two cases found in Theorem 2.1 and Corollary 2.2.

**Theorem 2.3.**

$$\Phi_{i,k;R,\rho}(a, b, c, d) = ST$$

where

$$S = \prod_{j=1}^{\infty} \frac{(1 + a^{\lceil \frac{(j+1)k+i}{2} \rceil} b^{\lfloor \frac{(j+1)k+i}{2} \rfloor} c^{\lceil \frac{jk+i}{2} \rceil} d^{\lfloor \frac{jk+i}{2} \rfloor})}{(1 - a^{\lceil \frac{jk+i}{2} \rceil} b^{\lfloor \frac{jk+i}{2} \rfloor} c^{\lceil \frac{jk+i}{2} \rceil} d^{\lfloor \frac{jk+i}{2} \rfloor})(1 - a^{jk} b^{(j-1)k} c^{jk} d^{(j-1)k})}$$

and

$$T = \prod_{r \in R} (1 - a^{\lceil \frac{r}{2} \rceil} b^{\lfloor \frac{r}{2} \rfloor} c^{\lceil \frac{r}{2} \rceil} d^{\lfloor \frac{r}{2} \rfloor})$$

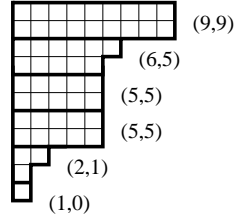

FIGURE 1.  $\lambda = (9, 9, 6, 5, 5, 5, 5, 5, 2, 1, 1)$  decomposes into blocks  $\{(9, 9), (6, 5), (5, 5), (5, 5), (2, 1), (1, 0)\}$

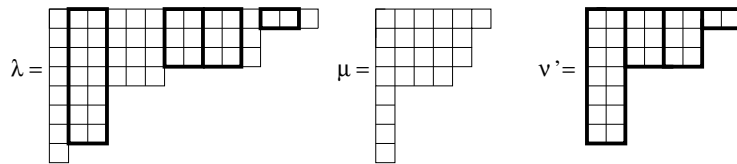

FIGURE 2.  $\lambda = (14, 11, 11, 6, 3, 3, 3, 3, 1)$  and  $f(\mu, \nu) = \lambda$  where  $\nu = (7, 7, 3, 3, 3, 3, 1, 1)$  and  $\mu = (6, 5, 5, 4, 1, 1, 1, 1)$

### 3. Combinatorial Proof of these Results

The proof of Theorem 2.3 is a slight modification of the proof of Theorem 2.1 and Corollary 2.2. The details of these proofs can be found in the complete version of the paper available at [math.CO/0308012](http://math.CO/0308012).

SKETCHED PROOF OF THEOREM 2.1. Consider the following class of partitions:

$$\mathcal{R} = \{\lambda \in \text{Par} : \lambda_{2i-1} - \lambda_{2i} \leq 1\}.$$

We are restricting the difference between a part of  $\lambda$  which is at an odd level and the following part of  $\lambda$  to be at most 1.

To find the generating function for partitions in  $\mathcal{R}$  under weight  $w(\lambda)$  we will decompose  $\lambda \in \mathcal{R}$  into blocks of height 2. Since the difference of parts is restricted to either 0 or 1 at odd levels, we can only get two types of block: for any  $k \geq 1$ , we can have a block with two parts of length  $k$ , and, for any  $k \geq 1$ , we can have a block with one part of length  $k$  and then other of length  $k - 1$ . Figure 1 shows an example of such a decomposition.

By considering the weights of these parts, we obtain the following generating function:

$$\sum_{\lambda \in \mathcal{R}} w(\lambda) = \prod_{j=1}^{\infty} \frac{(1 + a^j b^{j-1} c^{j-1} d^{j-1})(1 + a^j b^j c^j d^{j-1})}{(1 - a^j b^j c^j d^j)(1 - a^j b^{j-1} c^j d^{j-1})}.$$

Let  $\mathcal{S}$  be the set of partitions whose conjugates have only odd parts each of which is repeated an even number of times. We give a bijection  $f : \mathcal{R} \times \mathcal{S} \rightarrow \text{Par}$ , such that  $\mathcal{S}$  contributes exactly the missing terms. The map  $f$  consists of taking the partition whose columns are the union of the columns of the partition from  $\mathcal{R}$  and the columns of the partition for  $\mathcal{S}$ . An example is shown in Figure 2. The weight of the partition from  $\mathcal{S}$  does not change when  $f$  is applied and contributes

$$\prod_{j=1}^{\infty} \frac{1}{1 - a^j b^j c^{j-1} d^{j-1}},$$

the terms missing in  $\sum_{\lambda \in \mathcal{R}} w(\lambda)$ .

□

SKETCHED PROOF OF COROLLARY 2.2. To obtain this corollary, consider the following bijection. Let  $\mathcal{D}$  denote the set of partitions with distinct parts and let  $\mathcal{E}$  denote the set of partitions whose parts appear an even number of times. Then we have a bijection  $g : \text{Par} \rightarrow \mathcal{D} \times \mathcal{E}$  with  $g(\lambda) = (\mu, \nu)$  defined as follows. Suppose  $\lambda$  has  $k$  parts equal to  $i$ . If  $k$  is even then  $\nu$  has  $k$  parts equal to  $i$ , and if  $k$  is odd then  $\nu$  has  $k - 1$  parts equal to  $i$ . The parts of  $\lambda$  which were not removed to form  $\nu$ , at most one of each cardinality, give  $\mu$ . It is clear that under this bijection,  $w(\lambda) = w(\mu)w(\nu)$ .

By considering the weights of partition in  $\mathcal{E}$  we get that

$$\Phi(a, b, c, d) = \Psi(a, b, c, d) \prod_{j=1}^{\infty} \frac{1}{(1 - a^j b^j c^j d^j)(1 - a^j b^{j-1} c^j d^{j-1})}$$

and the result follows. □

**Acknowledgement.** The author would like to thank Richard Stanley for encouraging her to work on this problem.

### References

- [A] G. E. Andrews, *On a partition function of Richard Stanley*, to appear in the Electronic Journal of Combinatorics, available from <http://www.math.psu.edu/andrews/>.
- [Si] A. V. Sills, *A combinatorial proof of a partition identity of Andrews and Stanley*, to appear in the International Journal of Mathematics and Mathematical Sciences, available from <http://www.math.rutgers.edu/~asills/>.
- [St] R. P. Stanley, *Some remarks on sign-balanced and maj-balanced posets*, to appear in Advances in Applied Math., available from <http://www-math.mit.edu/~rstan/>.
- [Y] A. J. Yee, *On partition functions of Andrews and Stanley*, submitted for publication, available from <http://www.math.psu.edu/yee/>.

DEPARTMENT OF MATHEMATICS, MASSACHUSETTS INSTITUTE OF TECHNOLOGY, CAMBRIDGE, MA, 02139  
*E-mail address:* [cilanne@math.mit.edu](mailto:cilanne@math.mit.edu)





## Finite automata and pattern avoidance in words

Petter Brändén and Toufik Mansour

**Abstract.** We say that a word  $w$  on a totally ordered alphabet avoids the word  $v$  if there are no subsequences in  $w$  order-equivalent to  $v$ . In this paper we suggest a new approach to the enumeration of words on at most  $k$  letters avoiding a given pattern. By studying an automaton which for fixed  $k$  generates the words avoiding a given pattern we derive several previously known results for problems of this kind, as well as many new. In particular, we give a simple proof of the formula [21] for the exact asymptotics for the number of words on  $k$  letters of length  $n$  that avoids the pattern  $12 \cdots (\ell+1)$ . Moreover, we give the first combinatorial proof of the exact formula [9] for the number of words on  $k$  letters of length  $n$  avoiding a three letter permutation pattern.

**Résumé.** Soient  $v$  et  $w$ , deux mots sur un alphabet totalement ordonné. Le mot  $w$  évite le motif  $v$  si aucun sous-mot de  $w$  n'est équivalent (au sens de l'ordre) à  $v$ . Dans ce papier, nous suggérons une nouvelle approche pour énumérer les mots sur un alphabet d'au plus  $k$  lettres qui évitent un motif donné. En étudiant un automate qui engendre, pour un  $k$  fixé, tous les mots évitant un motif donné, nous obtenons des résultats nouveaux dans ce domaine, ainsi que d'autres déjà connus. En particulier, nous donnons une preuve simple de la formule de Regev pour une estimation asymptotique précise du nombre de mots de longueur  $n$  sur  $k$  lettres qui évitent le motif  $12 \cdots (\ell + 1)$ . De plus, nous donnons pour la première fois une preuve combinatoire de la formule close de Burstein pour le calcul du nombre de mots de longueur  $n$  sur un alphabet à  $k$  lettres qui évitent un motif de permutation de 3 lettres.

### 1. Introduction

In this paper we study pattern avoidance in words. The subject of pattern avoidance in permutations has thrived in the last decades, see [31] and the references there. Only very recently Alon and Friedgut [3] studied pattern avoidance in words to achieve an upper bound on the number of permutations in  $S_n$  avoiding a given pattern. We study pattern avoidance in words by defining a finite automaton that generates the words avoiding a given pattern and use the transfer matrix method to count them. By this approach we are able to find the asymptotics, as  $n \rightarrow \infty$ , for the number of words on  $k$  letters of length  $n$  avoiding a pattern  $p$ , as well as exact enumeration results. In particular we re-derive Regev's [21] result on the exact asymptotics for the number of words on  $k$  letters of length  $n$  avoiding a pattern  $12 \cdots (\ell + 1)$ , and give the first combinatorial proof of a formula for the number of words on  $k$  letters of length  $n$  avoiding the pattern 123.

Let  $S_n$  denote the set of permutations of the set  $[n] := \{1, 2, \dots, n\}$ . If  $\sigma \in S_k$  and  $\tau \in S_n$ , we say that  $\tau$  contains  $\sigma$  if there is a sequence  $1 \leq t_1 < t_2 < \dots < t_k \leq n$  of integers such that for all  $1 \leq i, j \leq k$  we

---

2000 Mathematics Subject Classification. 05A05, 05A15, 68Q45.

have  $\tau(t_i) \leq \tau(t_j)$  if and only if  $\sigma(i) \leq \sigma(j)$ . Here  $\sigma$  is called a *pattern*. If  $\tau$  does not contain  $\sigma$  we say that  $\tau$  *avoids*  $\sigma$ . In the study of pattern avoidance the focus has been on enumerating and giving estimates to the number of elements in the set  $S_n(\sigma)$ , the set of permutations in  $S_n$  that avoids  $\sigma$ . Maybe the most interesting open problem in the field is: Does there exist a constant  $c$  such that  $|S_n(\tau)| < c^n$  for all  $n \geq 0$ ? This problem is equivalent to the seemingly stronger statement, see [4]:

**Conjecture 1.1. (Stanley, Wilf)** *For any pattern  $\tau \in S_\ell$ , the limit  $\lim_{n \rightarrow \infty} |S_n(\tau)|^{\frac{1}{n}}$ , exists and is finite.*

The conjecture has been verified for *layered* patterns [8], for all patterns which can be written as an increasing subsequence followed by a decreasing [3]. Very recently Marcus and Tardos [19] announced that they have a proof of Conjecture 1.1. In [3] Alon and Friedgut proved a weaker version of Conjecture 1.1, namely: For any permutation  $\sigma$  there exists a constant  $c = c(\sigma)$  such that  $|S_n(\sigma)| \leq c^{n\gamma^*(n)}$ , where  $\gamma^*$  is an extremely slowly growing function, related to the Ackermann hierarchy. The method of proof in [3] was by considering pattern avoidance in words. This is also the theme of this paper.

Denote by  $[k]^*$  the set of all finite words with letters in  $[k]$ . If  $w = w_1 w_2 \cdots w_s \in [k]^*$  and  $v = v_1 v_2 \cdots v_r \in [m]^*$  where  $r \leq s$ , we say that  $w$  *contains* the *pattern*  $v$  if there is a sequence  $1 \leq t_1 < t_2 < \cdots < t_r \leq s$  such that for all  $1 \leq i, j \leq r$  we have

$$w_{t_i} \leq w_{t_j} \quad \text{if and only if} \quad v_i \leq v_j.$$

If  $w$  does not contain  $v$  we say that  $w$  *avoids*  $v$ . For example, the word  $w = 323122411 \in [4]^9$  avoids the pattern 132 and contains the patterns 123, 212, 213, 231, 312, and 321. If  $S$  is any set of finite words we denote the set of words in  $S$  that avoids  $v$  by  $S(v)$ .

The history of pattern avoidance in words is not as rich as the one in permutations. We mention the references [2, 3, 9, 10, 14, 21]. In [21] Regev gave a complete answer for the asymptotics for  $|[k]^n(p_\ell)|$  when  $n \rightarrow \infty$ , where  $p_\ell = 12 \cdots (\ell + 1)$  (see Theorem 4.3).

**Theorem 1.2 (Regev).** *For all  $k \geq \ell$  we have*

$$|[k]^n(p_\ell)| \simeq C_{\ell,k} n^{\ell(k-\ell)} \ell^n \quad (n \rightarrow \infty),$$

where

$$C_{\ell,k}^{-1} = \ell^{\ell(k-\ell)} \prod_{i=1}^{\ell} \prod_{j=1}^{k-\ell} (i+j-1).$$

**1.1. Organization of the paper.** The paper is organized as follows. In Section 2 we present the relevant definitions and attain some preliminary results, and in Section 3 we use the transfer matrix method to determine the asymptotic growth for the sequence  $n \mapsto |[k]^n(p)$ . In Section 4.1 we study the special features of the automaton,  $\mathcal{A}(p_\ell, k)$ , which generates the words with letters in  $[k]$  that avoids the increasing pattern  $12 \cdots (\ell + 1)$ . Here we will give a simple proof of Theorem 4.3 using the transfer matrix method and give a combinatorial proof for the formula [9] for  $|[k]^n(p)$ , where  $p$  is any permutation pattern of length three. We also consider the diagonal sequence  $|[n]^n(123)|$  and determine its asymptotic growth and we also show that its generating function is transcendental. We conclude the paper by indicating further problems connected to the work in this paper.

## 2. Definitions and preliminary results

Given a word-pattern  $p$  and an integer  $k > 0$  we define an equivalence relation  $\sim_p$  on  $[k]^*$  as follows:  $v \sim_p w$  if for every  $r \in [k]^*$  the word  $vr$  avoids  $p$  if and only if  $wr$  avoids  $p$ . For example, if  $p = 132$ ,  $k \geq 4$ ,  $v = 13$  and  $w = 14$ , then  $v \sim_p w$ , since 133 avoids  $p$  but 143 contains  $p$ . At first sight it may seem difficult to determine if  $v \sim_p w$ , since a priori there is an infinite number of right factors  $r$  to check. By the following lemma we have to check only a finite number words  $r$ .

**Lemma 2.1.** *Let  $p$  be a pattern of length  $\ell$  and let  $v, w \in [k]^*$  be any two words. Then  $v \sim_p w$  if and only if for all words  $r \in [k]^s$ ,  $0 \leq s \leq \ell - 1$ , we have*

$$vr \text{ avoids } p \quad \text{if and only if} \quad wr \text{ avoids } p.$$

PROOF. Define an equivalence relation  $\sim'_p$  on  $[k]^*$  by:  $v \sim'_p w$  if for all words  $r \in [k]^s$ ,  $0 \leq s \leq \ell$ , we have  $vr$  avoids  $p$  if and only if  $wr$  avoids  $p$ . Clearly,  $v \sim_p w$  implies  $v \sim'_p w$ . On the other hand if  $v \sim'_p w$  we may assume that there is an  $r \in [k]^*$  such that  $vr$  contains  $p$  and  $wr$  avoids  $p$ . There is at least one occurrence of  $p$  in  $vr$  that uses at most  $\ell - 1$  letters of  $r$ . Thus there is a subsequence  $r'$  of  $r$  of length at most  $\ell - 1$  such that  $vr'$  contains  $p$  and  $wr'$  avoids  $p$ , i.e.,  $v \not\sim'_p w$ .  $\square$

Let  $\mathcal{E}(p, k)$  be the set of equivalence classes of  $\sim_p$ . By Lemma 2.1 the number  $e$  of equivalence classes is finite. We denote the equivalence class of a word  $w$  by  $\langle w \rangle$ .

**Definition 2.2.** Given an positive integer  $k$  and a pattern  $p$  we define a *finite automaton* (For a definition of a finite automaton, see [1] and references therein),

$$\mathcal{A}(p, k) = (\mathcal{E}(p, k), [k], \delta, \langle \varepsilon \rangle, \mathcal{E}(p, k) \setminus \{\langle p \rangle\}),$$

by

- (1) the *states* are,  $\mathcal{E}(p, k)$ , the equivalence-classes of  $\sim_p$ ,
- (2)  $[k]$  is the *input alphabet*,
- (3)  $\delta : \mathcal{E}(p, k) \times [k] \rightarrow \mathcal{E}(p, k)$  is the *transition function* defined by  $\delta(\langle w \rangle, i) = \langle wi \rangle$ , where  $wi$  is  $w$  concatenated with the letter  $i \in [k]$ ,
- (4)  $\langle \varepsilon \rangle$  is the *initial state*, where  $\varepsilon$  is the empty word,
- (5) all states but  $\langle p \rangle$  are *final states*.

We will identify  $\mathcal{A}(p, k)$  with the (labelled) directed graph with vertices  $\mathcal{E}(p, k)$  and with a (labelled) edge  $\xrightarrow{i}$  between  $\langle v \rangle$  and  $\langle w \rangle$  if  $vi \sim_p w$ . Clearly, we may order the states as  $x_1, x_2, \dots, x_e$  so that if  $i < j$  there is no path from  $x_j$  to  $x_i$ . The *transition matrix*,  $T(p, k)$ , of  $\mathcal{A}(p, k)$  is the matrix of size  $e \times e$  with non-negative integer coefficients defined by:

$$[T(p, k)]_{ij} = |\{s \in [k] : \delta(x_i, s) = x_j\}|.$$

Thus  $[T(p, k)]_{ij}$  counts the number of edges between  $x_i$  and  $x_j$ , and  $T(p, k)$  is triangular.

**Example 2.3.** If  $p = 2314$  and  $k = 5$ , then it is easy to check (see [18]) that the states are  $\langle \varepsilon \rangle$ ,  $\langle 2 \rangle$ ,  $\langle 3 \rangle$ ,  $\langle 32 \rangle$ ,  $\langle 34 \rangle$ ,  $\langle 24 \rangle$ ,  $\langle 23 \rangle$ ,  $\langle 324 \rangle$ ,  $\langle 341 \rangle$ ,  $\langle 241 \rangle$ ,  $\langle 234 \rangle$ ,  $\langle 2342 \rangle$ ,  $\langle 231 \rangle$ , and  $\langle 2314 \rangle$ . Note that there are two edges between the states  $\langle 324 \rangle$  and  $\langle 241 \rangle$ , namely  $\langle 324 \rangle \xrightarrow{1} \langle 241 \rangle$  and  $\langle 324 \rangle \xrightarrow{2} \langle 241 \rangle$ . Moreover, all final states in  $\mathcal{A}(2314, 5)$  have 3 loops, except  $\langle 324 \rangle$  which has 2 loops.

The following simple lemma will be helpful in finding the asymptotic growth of the sequence  $|[n]^k(p)|$ , for fixed  $k$ .

**Lemma 2.4.** *Let the automaton  $\mathcal{A}(p, k)$  be given, let  $d$  be the number of distinct letters in  $p$  and suppose that  $k \geq d - 1$ . If  $\langle v \rangle$  is any state different from  $\langle p \rangle$ , then the number of loops at  $\langle v \rangle$  does not exceed  $d - 1$ . Moreover, there are exactly  $d - 1$  loops at  $\langle \varepsilon \rangle$ .*

PROOF. Suppose that there are more than  $d - 1$  loops at  $\langle v \rangle$ . Then the loops use at least  $d$  different labels. From these labels we can form a word  $w$  order-isomorphic to  $p$ . But then  $vw \sim_p v$  which is a contradiction.

We may assume that the letters of  $p$  are  $\{1, 2, \dots, d\}$ . Let  $p_1$  be the first letter of  $p$ . Then, if  $i < p_1$  or  $i > k - d + p_1$  we have  $i \sim_p \varepsilon$ . But there are  $d - 1$  such  $i$ 's, which proves the lemma.  $\square$

Although pattern avoidance in words and pattern avoidance in permutations share many common features, there are some important aspects in which they differ. For permutations there are three simple operations,  $f$ , that respect pattern-avoidance in the sense that  $f(\tau)$  avoids  $f(\sigma)$  if and only if  $\tau$  avoids  $\sigma$ , namely the reversal, the complement and the inverse of a permutation. The first two operations have obvious generalizations to words, while the inverse does not. It has in fact been an open question to construct an inverse for words possessing “the right” properties. Such an inverse was recently constructed by Hohlweg and Reutenauer [13]. Unfortunately it is not possible to construct an inverse that respects pattern avoidance in words, which would imply the identity  $||[k]^n(p)|| = ||[k]^n(p^{-1})||$ , for all  $k, n \geq 0$  and permutation patterns  $p$ . The first counter example to this is  $||[5]^7(1342)|| = 67854 > 67853 = ||[5]^7(1423)||$ . If  $w \in [k]^n$  let the complement of  $w$  in  $[k]^n$  be  $w^c = (k+1-w_1)(k+1-w_2) \cdots (k+1-w_n)$ . Then we have in fact that  $\mathcal{A}(p, k)$  and  $\mathcal{A}(p^c, k)$  are isomorphic as automata for any  $p \in [k]^*$ , since  $v \sim_p w$  if and only if  $v^c \sim_{p^c} w^c$ .

Certainly  $w$  avoids  $p$  if and only if  $w^r$  avoids  $p^r$ , where  $r$  is the reversal operator and  $w$  and  $p$  are any words. However  $\mathcal{A}(p, k)$  and  $\mathcal{A}(p^r, k)$  are not in general isomorphic. Indeed, for  $p = 2314$  and  $k = 5$  we have that  $|\mathcal{E}(2314, 5)| = 13$  and  $|\mathcal{E}(4132, 5)| = 14$ .

### 3. Transfer matrix method

In this section we use the transfer matrix method (see [27, Theorem 4.7.2]) to obtain information about the sequences  $||[k]^n(p)||$ . Given a matrix  $A$  let  $(A; i, j)$  be the matrix with row  $i$  and column  $j$  deleted.

**Theorem 3.1.** *Let  $k$  be a positive integer,  $p$  be a pattern and  $e_k$  be the number of states in  $\mathcal{A}(p, k)$ . Let  $T'(p, k) = (T(p, k); e_k - 1, e_k - 1)$ . Then the generating function for  $||[k]^n(p)||$  is*

$$\sum_{n \geq 0} ||[k]^n(p)|| x^n = \frac{\sum_{j=1}^{e_k-1} (-1)^{j+1} \det(I - xT', j, 1)}{\prod_{i=1}^{e_k-1} (1 - \lambda_i x)} = \frac{\det B(x)}{\prod_{i=1}^{e_k-1} (1 - \lambda_i x)},$$

where  $\lambda_i$  is the number of loops at state  $x_i$ , and  $B(x)$  is the matrix obtained by replacing the first column in  $I - xT'$  with a column of all ones.

PROOF. The theorem follows from the transfer matrix method, see [27, Theorem 4.7.2], since we want to count the number of paths of length  $n$  in  $\mathcal{A}(p, k)$  from  $\langle \varepsilon \rangle$  to any state other than  $\langle p \rangle$  of length  $n$  in  $\mathcal{A}(p, k)$ .  $\square$

Regev [21] computed the exact asymptotics for  $||[k]^n(p_\ell)||$ , where  $p_\ell = 12 \cdots (\ell + 1)$  and  $n \rightarrow \infty$ . We will next find the exact asymptotics (up to a constant) for  $||[k]^n(p)||$  for all patterns  $p$ . Given two sequences  $\{a_n\}$  and  $\{b_n\}$  of real numbers, we denote  $a_n \simeq b_n$  if  $\lim_{n \rightarrow \infty} \frac{a_n}{b_n} = 1$ . A path in  $\mathcal{A}(p, k)$  is called *simple* if it starts at  $\langle \varepsilon \rangle$ , does not use any loops, and does not end in  $\langle p \rangle$ .

**Theorem 3.2.** *Let  $p$  be any pattern with  $d$  distinct letters and let  $k \geq d - 1$  be given. Then there is a constant  $C > 0$  such that*

$$||[k]^n(p)|| \simeq C n^M (d - 1)^n \quad (n \rightarrow \infty),$$

where  $M + 1$  is the maximum number of states with  $d - 1$  loops, in a simple path.

PROOF. Let  $P := x_1, x_2, \dots, x_j$  be a simple path in  $\mathcal{A}(p, k)$ . Moreover, let  $\ell_j$  be the number of loops at state  $x_j$ . Then  $||[k]^n(p)|| = \sum_P N(P, n)$  where

$$N(P, n) = \sum_{\alpha_1 + \cdots + \alpha_j = n - j + 1} \ell_1^{\alpha_1} \ell_2^{\alpha_2} \cdots \ell_j^{\alpha_j},$$

and the sum is over all weak compositions of  $n - j + 1$  into at most  $j$  parts. Now,  $N(P, n)$  is equal to the coefficient to  $t^{n-j+1}$  in  $(1 - \ell_1 t)^{-1} \cdots (1 - \ell_j t)^{-1}$ . Let  $r$  be the number of  $i$  such that  $\ell_i = d - 1$ . Note that by Lemma 2.4  $r$  is at least one. The dominant term of  $(1 - \ell_1 t)^{-1} \cdots (1 - \ell_j t)^{-1}$  is (by partial fraction

decomposition) equal to  $\frac{f(t)}{(1-(d-1)t)^r}$ , where  $f(t)$  is a polynomial of degree less than  $r$  and  $f((d-1)^{-1}) \neq 0$ . By well known results it follows that  $N(P, n) \simeq C(P)(d-1)^n n^{r-1}$ , where  $C(P) > 0$  is a constant depending on  $P$  and  $k$ . Taking the greatest possible  $r$  yields the desired results.  $\square$

When there are exactly  $d-1$  loops at every state except  $\langle p \rangle$  in  $\mathcal{A}(p, k)$ , it follows from Theorem 3.1 that  $||[k]^n(p)| = (d-1)^n Q(n)$ , where  $Q$  is a polynomial in  $n$ . We have in fact:

**Corollary 3.3.** *Let  $\mathcal{A}(p, k)$  be such that all states but  $\langle p \rangle$  have exactly  $d-1$  loops. Then*

$$|[k]^n(p)| = \sum_{j=0}^M a_j (d-1)^{n-j} \binom{n}{j},$$

where  $a_j$  counts the number of simple paths of length  $j$  in  $\mathcal{A}(p, k)$ . Moreover, if  $p$  is a pattern of length  $\ell+1$  then  $a_j = (k-d+1)^j$  for all  $j = 0, 1, \dots, \ell$ .

PROOF. The corollary follows from the proof of Theorem 3.2 since  $N(P, n) = (d-1)^{n-j} \binom{n}{j}$ . If  $p$  is a pattern of length  $\ell+1$  then we have that  $a_j = (k-d+1)^j$  where  $j = 0, 1, \dots, \ell$ , since  $k^j = \sum_{i=0}^j a_i (d-1)^{j-i} \binom{j}{i}$  for all  $j = 0, 1, \dots, \ell$ .  $\square$

As an example of Corollary 3.3 we note that if  $p$  is any pattern of length  $\ell+1$  with exactly  $d$  different letters then  $||[d]^n(p)| = \sum_{j=0}^{\ell} (d-1)^{n-j} \binom{n}{j}$ .

#### 4. The increasing patterns

We will in this section investigate the properties of  $\mathcal{A}(p_\ell, k)$ , where  $p_\ell = 12 \cdots (\ell+1)$ . The following lemma describes the structure of  $\mathcal{A}(p_\ell, k)$ :

**Lemma 4.1.** *Let  $k \geq \ell$  be given. For any subset  $S$  of  $[k]$  of size  $\ell$  let  $w_S$  be the word consisting of the elements of  $S$  listed in increasing order. Then the words  $w_S$  together with  $p_\ell$  constitute a complete set of representatives for the equivalence-classes  $\mathcal{E}(p_\ell, k)$ . In particular we have:*

$$|\mathcal{E}(p_\ell, k)| = \binom{k}{\ell} + 1.$$

If  $S = \{s_1 < \cdots < s_\ell\} \subseteq [k]$  and  $j \in [k]$  let  $S^j = \{s_1 < \cdots < s_{i-1} < j < s_{i+1} < \cdots < s_\ell\}$ , where  $i$  is the integer such that  $s_{i-1} < j \leq s_i$  ( $s_0 := 0, s_{\ell+1} := k+1$ ). Then

$$\delta(\langle w_S \rangle, j) = \begin{cases} \langle w_{S^j} \rangle & \text{if } j \leq s_\ell, \\ \langle p_\ell \rangle & \text{otherwise.} \end{cases}$$

In particular, the loops of  $w_S$  are the elements of  $S$ .

PROOF. It is clear that the words  $w_S$  are representatives for different classes. Let  $v \in [k]^*(p_\ell)$ . We say that an increasing subword  $x_1 x_2 \cdots x_j$  of  $v$  is *extendible* if  $x_j \leq k+j-\ell-1$ , i.e., if we may extend  $x_1 x_2 \cdots x_j$  to an occurrence of  $p_\ell$  using letters from  $[k]$ . Suppose that the maximum length of an extendible increasing subsequence in  $v$  is equal to  $s$ ,  $s \leq \ell$ . For  $1 \leq j \leq s$  let

$$r_j(v) := \min\{x_j : x_1 x_2 \cdots x_j \text{ is an extendible subword of } v\}.$$

Clearly  $r_1(v) < r_2(v) < \cdots < r_s(v)$ . Let

$$S = \{r_1(v), r_2(v), \dots, r_s(v), k+s+1-\ell, k+s+2-\ell, \dots, k\}.$$

Then we see that  $w_S \sim v$ . The statement about the transition function follows from the construction.  $\square$

In the sequel we will use some standard notation from the theory of partitions and symmetric functions. For undefined terminology we refer the reader to Chapter 7 of [28].

**Theorem 4.2.** *Define a partial order on the final states in  $\mathcal{A}(p_\ell, k)$  as follows:  $x \leq y$  if there exists a path from  $x$  to  $y$  in  $\mathcal{A}(p_\ell, k)$ . Then this partial order is isomorphic to  $J([\ell] \times [k - \ell])$ , the lattice of order ideals of the poset  $[\ell] \times [k - \ell]$ .*

PROOF. Let  $S = \{s_1 < s_2 < \dots < s_\ell\}$  and  $T = \{t_1 < t_2 < \dots < t_\ell\}$  be subsets of  $[k]$ . We claim that there exists a path from  $\langle w_S \rangle$  to  $\langle w_T \rangle$  if and only if  $s_i \geq t_i$  for all  $1 \leq i \leq \ell$ . From this the theorem follows since the latter poset is isomorphic to the interval  $[\emptyset, \lambda_{\ell, k-\ell}]$ , in the Young's lattice, where  $\lambda_{\ell, k-\ell} := (k - \ell, k - \ell, \dots, k - \ell)$  is of length  $\ell$ . Indeed, consider the bijection defined by:

$$(s_1, s_2, \dots, s_\ell) \mapsto (s_\ell - \ell, s_{\ell-1} - \ell + 1, \dots, s_1 - 1) \in [\emptyset, \lambda_{\ell, k-\ell}].$$

Then  $s_i \geq t_i$  for all  $1 \leq i \leq j$  if and only if the image of  $S$  is greater than the image of  $T$  in  $[\emptyset, \lambda_{\ell, k-\ell}]$ . But  $[\emptyset, \lambda_{\ell, k-\ell}]$  is its own dual, so the statement follows from the simple fact that  $[\emptyset, \lambda_{\ell, k-\ell}]$  is isomorphic to  $J([\ell] \times [k - \ell])$ .

If there is an edge between  $\langle w_S \rangle$  and  $\langle w_T \rangle$ , we are done by Lemma 4.1. The “only if” direction thus follows by induction on the length of the path.

Now, if  $s_i \geq t_i$  for all  $1 \leq i \leq \ell$  consider the path

$$\langle w_S \rangle \xrightarrow{t_1} \langle w_{St_1} \rangle \xrightarrow{t_2} \langle w_{St_1 t_2} \rangle \xrightarrow{t_3} \dots \xrightarrow{t_\ell} \langle w_{St_1 t_2 \dots t_\ell} \rangle.$$

It is not hard to see that  $\langle w_{St_1 t_2 \dots t_\ell} \rangle = \langle w_T \rangle$ , which completes the proof.  $\square$

We now have a different proof of the following theorem of Regev [21]:

**Theorem 4.3** (Regev). *Let  $C_{\ell, k}^{-1} = \ell^{\ell(k-\ell)} \prod_{i=1}^{\ell} \prod_{j=1}^{k-\ell} (i+j-1)$ . For all  $k \geq \ell$  we have*

$$|[k]^n(p_\ell)| \simeq C_{\ell, k} n^{\ell(k-\ell)} \ell^n \quad (n \rightarrow \infty).$$

PROOF. By Corollary 3.3 and Theorem 4.2 we have that

$$|[k]^n(p_\ell)| \simeq a_M \ell^{-M} \binom{n}{M} \ell^n \simeq \frac{a_M}{M!} \ell^{-M} n^M \ell^n \quad (n \rightarrow \infty),$$

where  $M = \ell(k - \ell)$  and  $a_M$  is equal to the number of maximal chains in  $J([\ell] \times [k - \ell])$ . By [28, Proposition 7.10.3] and the hook-length formula [28, Corollary 7.21.6] we have that

$$a_{\ell(k-\ell)} = f^{\lambda_{\ell, k-\ell}} = \frac{(\ell(k-\ell))!}{\prod_{i=1}^{\ell} \prod_{j=1}^{k-\ell} (i+j-1)},$$

from which the theorem follows.  $\square$

It should be clear from the correspondence in Theorem 4.2 that the simple paths of length  $r$  in  $\mathcal{A}(p_\ell, k + \ell)$  are in a one-to-one correspondence with tableaux  $T$  of the following type:

- (i)  $T$  is weakly increasing in rows and columns,
- (ii) no integer appears in more than one row,
- (iii) the entries of  $T$  are exactly  $[r]$ ,
- (iv) the shape of  $T$  is contained in  $\lambda_{\ell, k}$ .

Recall that the tableaux satisfying (i) and (ii) above are the *border-strip* tableaux (or *rim-hook* tableaux)

of height zero. We call these tableaux *segmented*. Let  $a(\ell, k, r)$  denote the number of segmented tableaux satisfying (iii) and (iv), so that:

$$|[k + \ell]^n(p_\ell)| = \sum_{r=0}^{\ell k} \ell^{n-r} a(\ell, k, r) \binom{n}{r}. \tag{4.1}$$

The function  $a(\ell, k, r)$  is actually a polynomial in  $k$  of degree  $r$ . To see this let us call a segmented tableau inside  $[\ell] \times [k]$  *primitive* if all columns are different, and let the set of such tableaux of length  $i$  with  $r$  different entries be  $\mathcal{PR}_{\ell,i,r}$ . If we denote the number of elements in  $\mathcal{PR}_{\ell,i,r}$  by  $\text{pr}(\ell, i, r)$  we have

$$a(\ell, k, r) = \sum_{i=r/\ell}^r \text{pr}(\ell, i, r) \binom{k}{i},$$

since for any such primitive tableaux of length  $i$  we may insert  $\alpha_1$  copies of the first column before the first column,  $\alpha_2$  copies of the second column between the first and the second column, and so on. After the last column we may insert  $\alpha_{i+1}$  columns of all blanks, requiring that  $\alpha_1 + \alpha_2 + \dots + \alpha_{i+1} = k - i$ . Thus there are  $\binom{k}{i}$  segmented tableaux arising from a given primitive one. The numbers  $\text{pr}(\ell, i, r)$  are in general hard to count, but there are two special cases which are nice, namely  $\text{pr}(\ell, r, r)$  and  $\text{pr}(2, i, r)$ . We start by counting  $\text{pr}(\ell, r, r)$ .

**Theorem 4.4.** *With definitions as above:  $\text{pr}(\ell, n, n) = |S_n(p_\ell)|$ .*

PROOF. We will define a bijection between  $S_n$  and  $\cup_{\ell \geq 0} \mathcal{PR}_{\ell,n,n}$  such that the height of the tableau corresponds to the greatest increasing subsequence in the permutation. Recall the definition of  $r_i(v)$  in the proof of Lemma 4.1, and let  $r(v) = (r_1(v), r_2(v), \dots, r_\ell(v))$ , where  $\ell$  is the length of the longest increasing subsequence in  $v$ . Let  $k$  be large enough so that all increasing subsequences in permutations in  $S_n$  are considered extendible.

Now, if  $\pi = \pi_1 \pi_2 \dots \pi_n$  is any permutation in  $S_n$  define  $T = T(\pi)$  as follows. Let the first column of  $T$  be  $r(\pi)$ , the second column be  $r(\pi_1 \dots \pi_{n-1})$ , and so on. The image of the permutation 351462 is:

$$\begin{array}{cccccc} 1 & 1 & 1 & 1 & 3 & 3 \\ T(351462) = & 2 & 4 & 4 & 5 & 5 \\ & 6 & 6 & & & \end{array}$$

By Lemma 4.1 we have that  $T(\pi) \in \mathcal{PR}_{\ell,n,n}$ . Moreover from Lemma 4.1 we also get that a tableau  $T$  is the image of some  $\pi \in S_n$  if and only if

- (a)  $T$  has  $n$  columns and entries  $1, 2, \dots, n$ ,
- (b) Let  $T^i$  denote the  $i$ th column. If  $i < j$  then  $T^i$  is smaller than  $T^j$  in the product order. (If  $T^i$  and  $T^j$  have different size fill the empty slots of  $T^j$  with  $n + 1$ ),
- (c) Exactly one new entry appears every time you move from  $T^{i+1}$  to  $T^i$ .

Now, if  $T \in \cup_{\ell \geq 0} \mathcal{PR}_{\ell,n,n}$  condition (a) and (b) are trivially satisfied. At least one new entry appears every time we move from  $T^{i+1}$  to  $T^i$ , since otherwise  $T^i = T^{i+1}$  and  $T$  fails to be primitive. On the other hand if there appears more than one new entry in a transition then in a later transition there must appear no new entry, since  $T$  has  $n$  columns and  $n$  distinct entries. This verifies condition (c) and the theorem follows.  $\square$

A special case of Theorem 4.4 is that  $\text{pr}(2, n, n) = C_n$ , the  $n$ th Catalan number. This is also a special case of the next theorem. Note that Theorem 4.5 is what we need to have combinatorial proof of a closed formula, see Theorem 4.7, for the numbers  $|[k]^n(123)|$ . Burstein [9] achieved a different, but of course equivalent, formula for  $|[k]^n(123)|$ , but not in a bijective manner.

**Theorem 4.5.** *With definitions as above:  $\text{pr}(2, i, r) = \frac{1}{i+1} \binom{2i}{i} \binom{i}{r-i}$ .*

Before we give a proof of Theorem 4.5 we will need some definitions and a lemma. Let  $\mathcal{PR}^+(2, s, r)$  be the tableaux in  $\mathcal{PR}(2, s, r)$  that fill up the shape  $[2] \times [r]$ , and let  $\text{pr}^+(2, s, r) := |\mathcal{PR}^+(2, s, r)|$ . Then  $\text{pr}(2, s, r) = \text{pr}^+(2, s, r) + \text{pr}^+(2, s, r + 1)$  since we get the tableaux that do not fill up the shape by deleting all entries  $r + 1$ . To prove the theorem we will show that  $\text{pr}^+(2, s, r) = \binom{s-1}{2s-r} C_s$ , where  $C_s$  is the  $s$ th Catalan number.

We first define an operation  $+$  that takes tableaux with  $r$  different entries to tableaux with  $r + 1$  different entries. Let  $T \in \mathcal{PR}^+(2, s, r)$ . Suppose that  $j$  is an index such that  $T_{ij} = T_{i(j+1)}$  for some  $i = 1, 2$ . Write  $T$  as  $T = LR$  where  $L$  is the  $j$  first columns and  $R$  is the  $s - j$  last columns. Let  $R'$  be the array order equivalent to  $R$  with entries the same as  $R$ , add  $r + 1$ , take away  $T_{i(j+1)}$  (two arrays  $A$  and  $B$  are said to be order equivalent if  $A_{ij} \leq A_{i'j'}$  if and only if  $B_{ij} \leq B_{i'j'}$  for all  $i, j, i', j'$ ). We define  $T + j$  to be the tableaux  $T + j := LR'$ . In  $T$  there are exactly  $t = 2s - r$  indices  $j \in [s - 1]$  such that  $T_{ij} = T_{i(j+1)}$  for some  $i = 1, 2$ . Let  $S = \{s_1 < s_2 < \dots < s_t\}$  be these indices and define a function  $\Phi : \mathcal{PR}^+(2, s, r) \rightarrow \binom{s-1}{t} \times \mathcal{ST}_{2,s}$ , where  $\mathcal{ST}_{2,s}$  is the set of standard tableaux of shape  $[2] \times [s]$ , by

$$\Phi(T) = (S, T + s_t + s_{t-1} + \dots + s_1).$$

The fact that  $\Phi$  is a bijection will prove the theorem, since by the hook-length formula we have  $|\mathcal{ST}_{2,s}| = C_s$ . To find the inverse of  $\Phi$  we need a kind of inverse operation to  $+$ .

Let  $T \in \mathcal{PR}^+(2, s, r)$  and  $1 \leq b \leq s - 1$  be such that  $T_{1b} < T_{1(b+1)}$  and  $T_{2b} < T_{2(b+1)}$ . Define two arrays  $T|_b$  and  $T|^b$  as follows. Write  $T = LR$  where  $L$  are the  $b$  first columns and  $R$  are the  $s - b$  last columns. Define  $T|^b := L'R'$ , to be the array where  $L = L'$  and  $R'$  is the unique array order equivalent to  $R$ , with entries the same as  $R$  add  $T_{1b}$  take away  $r$ . Similarly, let  $T|_b := L'R'$ , be the array with  $L = L'$  and where  $R'$  is the unique array order equivalent with  $R$ , with entries the same as  $R$ , add  $T_{2b}$  take away  $r$ .

$$\begin{array}{c} 1 \ 2 \ 4 \ 4 \\ 3 \ 5 \ 6 \ 7 \end{array} \Big|_2^2 = \begin{array}{c} 1 \ 2 \ 2 \ 2 \\ 3 \ 5 \ 4 \ 6 \end{array}$$

$$\begin{array}{c} 1 \ 2 \ 4 \ 4 \\ 3 \ 5 \ 6 \ 7 \end{array} \Big|_2 = \begin{array}{c} 1 \ 2 \ 4 \ 4 \\ 3 \ 5 \ 5 \ 6 \end{array}$$

Note that exactly one of  $T|^2$  and  $T|_2$  above is a primitive segmented tableaux. This is no accident.

**Lemma 4.6.** *Let  $T \in \mathcal{PR}^+(2, s, r)$  and  $1 \leq b \leq s - 1$  be such that  $T_{1b} < T_{1(b+1)}$  and  $T_{2b} < T_{2(b+1)}$ . Then*

$$T|_b \in \mathcal{PR}^+(2, s, r - 1) \Leftrightarrow T|^b \notin \mathcal{PR}^+(2, s, r - 1) \Leftrightarrow T_{2(b+1)} = T_{2b} + 1.$$

Moreover, if  $B = T|^b \in \mathcal{PR}^+(2, s, r - 1)$  then  $B_{1b} = B_{1(b+1)}$  and if  $A = T|_b \in \mathcal{PR}^+(2, s, r - 1)$  then  $A_{1b} = A_{1(b+1)}$ .

PROOF. Consider  $A := T|_b$ . All entries in  $T$  that are smaller than  $T_{2b}$  will be mapped onto themselves and  $A_{ij} = T_{ij} - 1$  for  $A_{ij} > T_{2b}$ . Therefore  $A \in \mathcal{PR}^+(2, s, r - 1)$  if and only if  $T_{2(b+1)} = T_{2b} + 1$  (since otherwise the entry  $T_{2b}$  will appear in both the first and the second row).

Consider  $B := T|^b$ . Let  $y_i, i = 1, 2, \dots, h$  be the entries in  $T$  satisfying  $T_{2b} < y_i \leq T_{2(b+1)}$  ordered by size. Then the entry  $y_1$  will be mapped to an element smaller than  $T_{2b}$  and  $y_i$  will be mapped to  $y_{i-1}$  for  $i > 1$ . Thus  $B \in \mathcal{PR}^+(2, s, r - 1)$  if and only if  $T_{2(b+1)} > T_{2b} + 1$  as claimed.

The last statement is a direct consequence of the above proof.  $\square$

We are now ready to give a proof of Theorem 4.5.

PROOF OF THEOREM 4.5. If  $T \in \mathcal{PR}^+(2, s, r)$  and  $1 \leq b \leq s - 1$  are such that  $T_{1b} < T_{1(b+1)}$  and  $T_{2b} < T_{2(b+1)}$  we define  $T - b$  to be the one of the arrays  $T|_b$  and  $T|^b$  which is in  $\mathcal{PR}^+(2, s, r - 1)$ . By



Lemma 4.6 we have that

$$\begin{aligned} (T + j) - j = T & \quad \text{if } T_{ij} = T_{i(j+1)} \quad \text{for some } i = 1, 2, \\ (T - j) + j = T & \quad \text{if } T_{ij} < T_{i(j+1)} \quad \text{for both } i = 1, 2. \end{aligned} \quad (4.2)$$

Now, if  $S = \{x_1 < x_2 < \dots < x_t\}$ , where  $t = 2s - r$  and  $P \in \mathcal{ST}_{2,s}$  we let

$$\Psi(S, P) := P - x_1 - x_2 - \dots - x_t.$$

By 4.2 it follows that  $\Psi$  is the inverse to  $\Phi$  and the theorem follows.  $\square$

We now have a combinatorial proof of the following theorem given in a different form in [9]:

**Theorem 4.7.** *For all  $n, k \geq 0$  we have*

$$|[k + 2]^n(123)| = \sum_{r,i} 2^{n-r} C_i \binom{i}{r-i} \binom{n}{r} \binom{k}{i},$$

where  $C_i$  is the  $i$ th Catalan number. The generating function

$$F(x, y) := \sum_{n,k} |[k + 2]^n(123)| x^k y^n,$$

is given by

$$F(x, y) = \frac{1}{(1-x)(1-2y)} C\left(\frac{xy(1-y)}{(1-x)(1-2y)^2}\right),$$

where  $C(z)$  is the generating function for the Catalan numbers. Equivalently,  $F(x, y)$  is algebraic of degree two and satisfies the equation:

$$x(1-x)y(1-y)F^2 - (1-x)(1-2y)F + 1 = 0.$$

To complete the picture for permutation patterns of length 3 it remains to enumerate  $|[k]^n(132)|$ . Simion and Schmidt [25] introduced a simple bijection between  $S_n(123)$  and  $S_n(132)$  which fixes each element of  $S_n(123) \cup S_n(132)$ . West [30] generalized this bijection to obtain a bijection between  $S_n(p)$  and  $S_n(q)$  where  $p(\ell) = q(\ell - 1) = \ell$ ,  $p(\ell - 1) = q(\ell) = \ell - 1$ , and  $p, q \in S_\ell$ . This bijection, in turn, generalizes to words as follows.

**Theorem 4.8.** *Let  $p = p_1 p_2 \dots p_\ell$  be a pattern with greatest entry equal to  $d$  and  $p_{\ell-1} = d - 1$ ,  $p_\ell = d$ . If  $d$  occurs exactly once in  $p$  then*

$$|[k]^n(p)| = |[k]^n(\tilde{p})|,$$

where  $\tilde{p} = p_1 p_2 \dots p_\ell p_{\ell-1}$ .

PROOF. The proof is a straight forward generalization of West's algorithm presented in [30, Sec. 3.2].  $\square$

For example, if  $p = 132$  then  $\tilde{p} = 123$ . Hence, by Theorem 4.8 we get that if  $p$  and  $q$  are any permutation patterns of length 3 then  $|[k]^n(p)| = |[k]^n(q)|$  for all  $n, k \geq 0$  (see [9] for an analytical proof). If  $p = 1232$  then  $\tilde{p} = 1223$ . Hence, Theorem 4.8 gives  $|[k]^n(1232)| = |[k]^n(1223)|$  for all  $n, k \geq 0$ .

Since,  $S_n(p) \subset [n]^n(p)$ , the numbers  $|[n]^n(p)|$  are interesting. A sequence  $f(n)$  is *polynomially recursive* ( $P$ -recursive) if there is a finite number of polynomials  $P_i(n)$  such that  $\sum_{i=0}^N P_i(n) f(n+i) = 0$ , for all integers  $n \geq 0$ . For the case when  $p$  is permutation pattern of length 3 we have the following:

**Theorem 4.9.** *Let  $p$  be a permutation pattern of length 3. Then the sequence  $f(n) := |[n]^n(p)|$  is  $P$ -recursive and satisfies the three term recurrence:*

$$p(n)f(n-2) + q(n)f(n-1) + r(n)f(n) = 0,$$

where

$$\begin{aligned} p(n) &= 3(n-3)(n-1)(3n-5)(3n-4)(5n-4), \\ q(n) &= 288 - 1440n + 2780n^2 - 2435n^3 + 976n^4 - 145n^5, \quad \text{and} \\ r(n) &= 2(n-2)^2n(n+1)(5n-9). \end{aligned}$$

PROOF. The fact that  $f(n)$  is  $P$ -recursive follows easily from the expansion of  $f(n)$  as a double sum using Theorem 4.7 and the theory developed in [17]. The polynomials  $p, q$  and  $r$  were found using the package MULTISUM (see [29]) developed by Wegschaider and Riese.  $\square$

**Corollary 4.10.** *The asymptotics of  $f(n) = |[n]^n(123)|$  is given by  $f(n) \sim Cn^{-2} \left(\frac{27}{2}\right)^n$ , where  $C > 0$  is a constant.*

PROOF. This is a direct consequence of Theorem 4.9 and the theory of asymptotics for  $P$ -recursive sequences, see [32].  $\square$

A consequence of this is that the generating function of  $f(n)$  is transcendental, since the exponent of  $n$  in the asymptotic expansion of a sequence with an algebraic generating function is never a negative integer.

**4.1. Generating function approach.** In this section we will investigate the generating function that enumerates the number of segmented tableaux according to size of rows and number of different entries. Let  $A_\ell(x_1, x_2, \dots, x_\ell, t)$  be the generating function:

$$A_\ell = \sum_T x_1^{\lambda_1(T)} x_2^{\lambda_1(T) - \lambda_2(T)} \dots x_\ell^{\lambda_{\ell-1}(T) - \lambda_\ell(T)} t^{N(T)},$$

where  $\lambda_i(T)$  denotes the size of row  $i$  in  $T$ ,  $N(T)$  denotes the number of different entries in  $T$  and the sum is over all segmented tableaux with at most  $\ell$  rows. For  $i = 1, 2, \dots, \ell$  let  $A_\ell^i(x_1, \dots, x_\ell, t)$  be the generating function for those tableaux which have their maximal entry in row  $i$ . If  $F(x_1, x_2, \dots, x_n)$  is a formal power-series in  $n$  variables the *divided difference* of  $F$  with respect to the variable  $x_i$  is  $\Delta_i F := \frac{F - F(x_i=0)}{x_i}$ , where  $F(x_i=0)$  is short for  $F(x_1, x_2, \dots, x_{i-1}, 0, x_{i+1}, \dots, x_n)$ .

**Theorem 4.11.** *With definitions as above we have that  $A_\ell$  satisfies the following system of equations:*

$$\begin{aligned} A_\ell &= 1 + A_\ell^1 + \dots + A_\ell^\ell, \\ A_\ell^1 &= x_1 x_2 t A_\ell + x_1 x_2 A_\ell^1, \\ A_\ell^2 &= x_3 t \Delta_2 A_\ell + x_3 \Delta_2 A_\ell^2, \\ &\vdots \\ A_\ell^{\ell-1} &= x_\ell t \Delta_{\ell-1} A_\ell + x_\ell \Delta_{\ell-1} A_\ell^{\ell-1}, \\ A_\ell^\ell &= t \Delta_\ell A_\ell + \Delta_\ell A_\ell^\ell. \end{aligned}$$

PROOF. The theorem follows by treating two separate cases. Let  $n$  be the greatest entry in the tableau  $T$ . The case when there is one  $n$  in a row corresponds to the first summand and the case when there are more than one  $n$  in a row corresponds to the second summand.  $\square$

When  $\ell = 2$ ,  $A = A_2$ , the system boils down to:

$$\left( (1 - x_2^{-1}) \left( 1 - \frac{x_1 x_2 t}{1 - x_1 x_2} \right) - x_2^{-1} t \right) A = 1 - x_2^{-1} (1 + t) A(x_2 = 0). \quad (4.3)$$

This equation can be solved using the so called *kernel method* as described in [5]. If we let

$$x_2 = \frac{1 + x_1(1 + 2t) - \sqrt{(1 + x_1(1 + 2t))^2 - 4x_1(1 + t)^2}}{2x_1(1 + t)},$$

then the parenthesis in front of  $A$  in 4.3 cancels, and we get:

$$A(x_2 = 0) = \frac{1 + x_1(1 + 2t) - \sqrt{(1 + x_1(1 + 2t))^2 - 4x_1(1 + t)^2}}{2x_1(1 + t)^2}.$$

By the interpretation of  $a(\ell, k, r)$ , we have that the bi-variate generating function for  $a(2, k, r)$  is  $(1 + x_1)^{-1}A_2(x_1, 1, t)$ . From this and 4.1 one may derive an analytic proof of Theorem 4.7.

### 5. Further results and open problems

**5.1. Further directions.** Recall that the Stanley-Wilf Conjecture asserts that for any permutation  $\pi$  the limit  $\lim_{n \rightarrow \infty} |S_n(\pi)|^{1/n}$  exists and is finite. What about the sequence  $|[n]^n(\pi)|$ ?

**Problem 5.1.** *Let  $\pi$  be a permutation. Is there a constant  $0 < C < \infty$  such  $|[n]^n(\pi)| \leq C^n$  for all  $n \geq 0$  ?*

Note that the answer to Problem 5.1 is no when  $\pi$  is not a permutation, since then  $S_n = S_n(\pi) \subseteq [n]^n(\pi)$ . Again, Problem 5.1 is equivalent to the statement that

$$\lim_{n \rightarrow \infty} |[n]^n(\pi)|^{1/n},$$

exists and is finite. This is because for all  $m, n \geq 0$  we have

$$|[n + m]^{n+m}(\pi)| \geq |[n]^n(\pi)| \cdot |[m]^m(\pi),$$

so we may apply Fekete’s Lemma on sub-additive sequences. See [4, Theorem 1] for details (the proof extends to words word for word). For permutations  $\pi \in S_3$  we have by Corollary 4.10 that  $\lim_{n \rightarrow \infty} |[n]^n(\pi)|^{1/n} = 27/2$  as opposed to  $\lim_{n \rightarrow \infty} |S_n(\pi)|^{1/n} = 4$ .

For which permutations do we know Problem 5.1 holds? It follows from the work in [3] Problem 5.1 holds for all permutations which can be written as an increasing sequence followed by a decreasing. Also, with no great effort Bóna’s proof [8] of the Stanley-Wilf conjecture for layered patterns may be extended to this setting. Thus for all classes that the Stanley-Wilf conjecture is known to hold, the seemingly stronger Problem 5.1 holds. The following conjecture therefore seems plausible:

**Conjecture 5.2.** *For all permutations  $\pi$  we have:*

$$\exists C \forall n (|[n]^n(p)| \leq C^n) \Leftrightarrow \exists D \forall n (|S_n(p)| \leq D^n).$$

There are several problems concerning the automaton associated to a pattern that has connections to the above problems. One problem is to give an estimate to the number of simple paths in  $\mathcal{A}(p, k)$ , another is to estimate the number of equivalence classes in  $\mathcal{A}(p, k)$ . Yet another problem is to give an estimate to the maximum size of an equivalence class.

**5.2. Formula for  $|[k]^n(p)|$ .** Our algorithm (see Theorem 3.1) for finding a formula for  $|[k]^n(p)|$  is implemented in C++ and Maple, see [18]. The first with input  $p$  and  $k$  and output the automaton  $\mathcal{A}(p, k)$  and the second with input the automaton  $\mathcal{A}(p, k)$  and output the exact formula for  $|[k]^n(p)|$ . This algorithm allows us to get an explicit formula for  $|[k]^n(p)|$  where  $p \in S_k$  and  $k \geq 1$  are given. For example, an output for the algorithm for  $p \in S_4$  and  $k = 3, 4, 5, 6$  is given by [18].

Finally we remark that our method can be generalized as follows. Given a set of patterns  $T$  we define an equivalence relation  $\sim_T$  on  $[k]^*$  by:  $v \sim_T w$  if for all words  $r \in [k]^*$  we have  $vr$  avoids  $T$  if and only if  $wr$  avoids  $T$ , where a word  $u$  avoids  $T$  if  $u$  avoids all patterns in  $T$ . As in Section 2 we define an automaton  $\mathcal{A}(T, k)$  with the equivalence classes of  $\sim_T$  as states. With minor changes in the proof, Theorem 3.1 can be extended to avoidance of a set of patterns. For example, if  $T = \{1234, 2134\}$  and  $k = 6$ , then by [18] we get that

$$(5.1) \quad |[6]^n(T)| = 4 \cdot 3^n + 12 \binom{n}{2} 3^{n-2} + 24 \binom{n}{3} 3^{n-3} + 54 \binom{n}{4} 3^{n-4}$$

$$(5.2) \quad + 60 \binom{n}{5} 3^{n-5} + 40 \binom{n}{6} 3^{n-6} - 3 \cdot 2^n.$$

**Acknowledgements.** We would like to thank M. Bousquet-Mélou and C. Krattenthaler for interesting discussions, D. Zeilberger for informing us about the work of Wegschaider and Riese, and Wegschaider and Riese for running their program for us.

### References

- [1] A. V. AHO, R. SETHI, J.D. ULLMAN, Compilers: principles, techniques and tools, Addison-Wesley, Reading, Mass., 1986.
- [2] M. ALBERT, R. ALDRED, M.D. ATKINSON, C. HANDLEY, AND D. HOLTON, Permutations of a multiset avoiding permutations of length 3, *Europ. J. Combin.* **22** (2001) 1021–1031.
- [3] N. ALON AND E. FRIEDGUT, On the number of permutations avoiding a given pattern, *J. Combin. Theory Series A* **89** (2000) 133–140.
- [4] R. ARRATIA, On the Stanley-Wilf conjecture for the number of permutations avoiding a given pattern, *Elect. J. Combin.* **6** (1999) (electronic)
- [5] C. BANDERIER AND M. BOUSQUET-MÉLOU AND A. DENISE, AND P. FLAJOLET AND D. GARDY AND D. GOUYOU-BEAUCHAMPS, Generating functions for generating trees, Formal power series and algebraic combinatorics (Barcelona, 1999). *Discr. Math.* **246** (2002) 29–55.
- [6] M. BÓNA, Permutations avoiding certain patterns: the case of length 4 and some generalization, *Discr. Math.* **80** (1997) 257–272.
- [7] M. BÓNA, Exact enumeration of 1342-avoiding permutations: A close link with labelled trees and planar maps, *J. Combin. Theory Series A* **175** (1997) 55–67.
- [8] M. BÓNA, The solution of a conjecture of Stanley and Wilf for all layered patterns, *J. Combin. Theory Series A* **85** (1999) 96–104.
- [9] A. BURSTEIN, Enumeration of words with forbidden patterns, Ph.D. thesis, University of Pennsylvania, 1998.
- [10] A. BURSTEIN AND T. MANSOUR, Words restricted by patterns with at most 2 distinct letters, *Elect. J. Combin.* **9:2** (2002) #R3.
- [11] I.M. GESSEL, Symmetric functions and  $P$ -recursiveness, *J. Combin. Theory Series A* **53** (1990) 257–285.
- [12] J. M. HAMMERSLEY, A few seedlings of research, *Proceedings Sixth Berkeley Symposium on Mathematical Statistics and Probability*, Volume **1**, Berkeley/Los Angeles, 1972, University of California Press, 345–394.
- [13] C. HOHLWEG AND C. REUTENAUER, Inverses of words and the parabolic structure of the symmetric group, *Europ. J. Combin.* **22** (2001) 1075–1082.
- [14] M. KLAZAR, The Füredi-Hajnal conjecture implies the Stanley-Wilf conjecture, Formal power series and algebraic combinatorics (Moscow,2000), Springer, Berlin (2000) 250–255
- [15] D.E. KNUTH, The art of computer programming, Volume **1**, Fundamental algorithms, Addison Wesley, Reading, Massachusetts, 1973.
- [16] D.E. KNUTH, The art of computer programming, Volume **3**, Fundamental algorithms, Addison Wesley, Reading, Massachusetts, 1973.
- [17] L. LIPSHITZ,  $D$ -finite power series, *J. Algebra* **122** (1989) 353–373.
- [18] T. MANSOUR, Finite automata and pattern avoidance, Maple Programming, Available in <<http://math.haifa.ac.il/toufik>>.
- [19] A. MARCUS AND G. TARDOS, On 0-1 matrices and small excluded submatrices, <<http://www.renyi.hu/~tardos/submatrix.ps>>, 2003.
- [20] A. REGEV, Asymptotic values for degrees associated with strips of Young diagrams, *Adv. Math.* **41** (1981) 115–136.
- [21] A. REGEV, Asymptotics of the number of  $k$ -words with an  $\ell$ -descent, *Elect. J. Combin.* **5** (1998) #R15.
- [22] D. G. ROGERS, Ascending sequences in permutations, *Discr. Math.* **22** (1978) 35–40.
- [23] D. ROTEM, On a correspondence between binary trees and a certain type of permutation, *Info. Proc. Letters* **4** (1975) 58–61.
- [24] D. ROTEM, Stack sortable permutations, *Discr. Math.* **33** (1981) 185–196.
- [25] R. SIMION AND F. SCHMIDT, Restricted permutations, *Europ. J. Combin.* **6** (1985) 383–406.

- [26] N. SLOANE AND S. PLOUFFE, The Encyclopedia of Integer Sequences, Academic Press, New York, 1995.
- [27] R. STANLEY, Enumerative Combinatorics, Volume **1**, Cambridge University Press, Cambridge, 1997.
- [28] R. STANLEY, Enumerative Combinatorics, Volume **2**, Cambridge University Press, Cambridge, 1999.
- [29] K. WEGSCHAIDER AND A. RIESE, A Mathematica package for proving hypergeometric multi-sum identities, Available in <http://www.risc.uni-linz.ac.at/research/combinat/risc/software>.
- [30] J. WEST, Permutations with forbidden subsequences and stack sortable permutations, Ph.D. Thesis, M.I.T., (1990).
- [31] H. WILF, The patterns of permutations, *Discr. Math.* **257** (2002) 575–583.
- [32] J. WIMP AND D. ZEILBERGER, Resurrecting the asymptotics of linear recurrences, *J. Math. Anal. Appl.* **111** (1985) 162–176.

MATEMATIK, CHALMERS TEKNISKA HÖGSKOLA OCH GÖTEBORGS UNIVERSITET, S-412 96 GÖTEBORG, SWEDEN.  
*E-mail address:* `branden@math.chalmers.se`

DEPARTMENT OF MATHEMATICS, HAIFA UNIVERSITY, 31905 HAIFA, ISRAEL.  
*E-mail address:* `toufik@math.haifa.ac.il`





## Height Arrow Model

Arnaud Dartois and Dominique Rossin

**Abstract.** *We study in this article the characteristics of the so-called Height-Arrow Model (HAM), introduced by physicists as an extension of the Abelian Sandpile Model and the Eulerian Walker. We show that recurrent configurations of this model form an Abelian group and that classical algorithms such as the recurrence criterion or the burning algorithm for the ASM could be extended to the HAM.*

**Résumé.** *Dans cet article, nous étudions le modèle dit hauteur-orientation introduit par des physiciens comme une généralisation du modèle du Tas de Sable Abélien et du Marcheur Eulérien. Nous montrons que les configurations récurrentes du système forment un groupe Abélien dont le cardinal est lié aux arbres couvrants du graphe sous-jacent. De plus, nous généralisons quelques algorithmes classiques connus pour le modèle du Tas de Sable Abélien comme le critère de récurrence ou l'algorithme de mise à feu.*

### Introduction

Bak, Tang and Wiesenfeld [BTW87] introduced in 1987 a simple model based on a cellular automaton which depicted the critical behaviour of self-organized systems. This model has been extensively studied by physicists [DM91], [DRSV95], and combinatorists [Big99], [Big96], [CR00], [CGB02].

This system presents two different aspects:

- A dynamical approach. Starting from a given configuration, we let the system evolve and the series of configurations it reaches under the action of the evolution rules describes its dynamic.
- The second aspect was pointed out by Dhar, Ruelle, Sen and Verma [DRSV95]. The space of recurrent configurations -i.e. those which can appear after a long evolution of the system- is an Abelian group.

The Eulerian Walkers Model (EWM) was introduced by Priezzhev, Dhar and al. in [PDDK02]. This model shares with the Abelian Sandpile Model (ASM) the Abelian group property. Both models involve a rooted map  $G$ , where some particles (also called grains or walkers sometimes) could be put on every vertex except the sink. Then the system evolves according to a toppling rule. At the end of [PDDK02] a general model is proposed which generalizes EWM and ASM. This paper is a detailed analysis of this model called Height Arrow Model (HAM).

In the first part we give basic definitions of the model and the underlying structure of combinatorial map. Then, we study the configurations of the system and show that some of them, called recurrent ones,

---

1991 *Mathematics Subject Classification.* Primary 05C90, 05C45; Secondary 68R05.

*Key words and phrases.* sandpile, eulerian walker.

are closely related to the recurrent of the ASM. In the last part we study the group associated to each of the different model and point out correlations between them.

## 1. Definition of the model

**1.1. Configurations of the HAM.** The HAM is usually described with respect to an order for the edges around a vertex. Hence, the natural structure to define the HAM is a combinatorial map. This is the embedding of a graph on a surface.

**Definition 1.1.** A *combinatorial map* on a (finite) set  $B$  is a pair of permutations  $(\sigma, \alpha)$  of  $B$  such that:

- (1)  $\alpha$  is a fixed-point free involution,
- (2) the group  $\langle \sigma, \alpha \rangle$  generated by the two permutations is transitive.

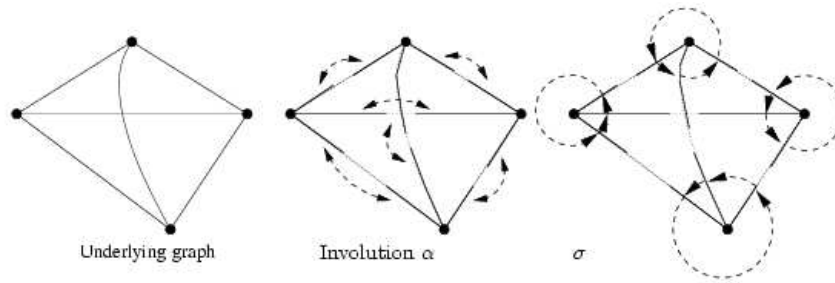

FIGURE 1. A combinatorial map  $(\sigma, \alpha)$

The elements of  $B$  are called the *half-edges* (also called *brins*). The cycles of  $\sigma$  are the *vertices* and those of  $\alpha$  are the *edges*. The pair of partitions  $(V, E)$  of  $B$  induced by the vertices and the edges constitutes the *underlying graph* of the map. In particular  $|B| = 2|E|$ . Property (2) implies that the underlying graph of a combinatorial map is connected. We say that a combinatorial map is *simple* if its underlying graph is simple i.e., it contains neither parallel edges nor loops. For more details on maps, see [CM92].

Such a map can be seen as a graph where the edges around each vertex are ordered.

A  $\tau$ -map is a pair  $\mathcal{M}^\tau = (\mathcal{M}, \tau)$  where  $\mathcal{M}$  is a combinatorial map and  $\tau \in \mathbb{N}^V$  a vector of integers such that  $\tau_i$  is an attribute of vertex  $i$  satisfying  $0 \leq \tau_i \leq d_i$ , where  $d_i$  is the degree of vertex  $i$  (the size of the orbit of  $\sigma$  for half-edges adjacent to  $i$ ). A  $\tau_q$ -map is a  $\tau$ -map where a vertex  $q$  is distinguished and verifies  $\tau_q = d_q$ . This vertex will be called the *sink*.

**Definition 1.2.** Given a  $\tau_q$ -map, a *configuration* of the HAM is a pair  $u = (h, \omega)$  where:

$$\forall i \neq q, \begin{cases} h(i) \in \mathbb{Z} \\ w(i) \text{ is an half-edge adjacent to } i \end{cases}$$

The application  $h$  is called the height configuration of  $u$  and  $\omega$  the arrow configuration or orientation of  $u$ .

For example, figure 2 shows a configuration on a  $\tau_q$ -map. The attribute  $\tau$  is represented by integers outside each vertex. Height  $h$  is represented by integers inside vertices and  $\omega$  by an arrow going out each vertex.



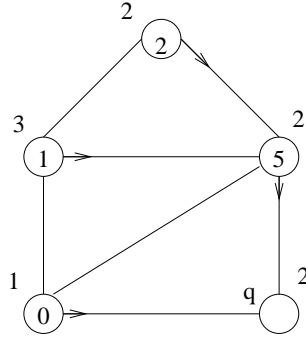

FIGURE 2. A  $\tau_q$ -map and a configuration on it

A configuration is *stable* if  $h(i) < \tau_i$  for all vertices  $i$  except  $q$ . Otherwise, it is called *unstable*. In this case, as in figure 2, a vertex can topple. In this example vertices with height 2 and 5 are unstable and can topple.

**Toppling rule** If a vertex  $i$  is unstable then repeat  $\tau_i$  times the following operations:

- (1) change the arrow from  $\omega(i)$  to  $\sigma(\omega(i))$ ,
- (2) send a grain along the new arrow  $\omega(i)$  towards half-edge  $\alpha(\omega(i))$  till the next vertex  $j$ . Then,  $h(i) \leftarrow h(i) - 1$  and  $h(j) \leftarrow h(j) + 1$ .

In this process we say that half-edges  $\sigma(\omega(i)), \sigma^2(\omega(i)), \dots, \sigma^{\tau_i}(\omega(i))$  are *visited*.

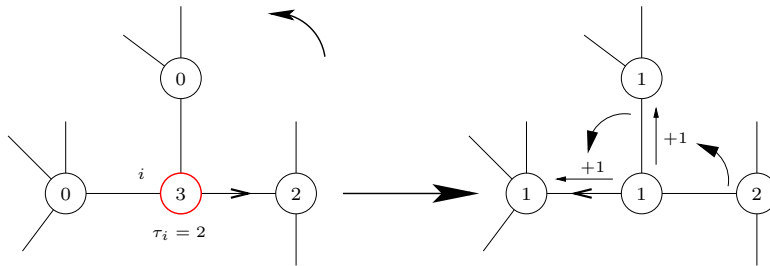

FIGURE 3. Toppling rule

We retrieve the Eulerian Walker Model when  $\tau_i = 1$  for every vertex and the Abelian Sandpile Model when  $\tau_i = d_i$ .

**1.2. Relaxation of a configuration.** Let  $u$  be a configuration such that vertex  $i$  is unstable, and let  $u'$  be the configuration obtained from  $u$  by toppling vertex  $i$ . We will note by  $u \xrightarrow{i} u'$  this toppling operation, and more generally by  $u \xrightarrow{s} u'$  if  $u'$  is obtained from  $u$  by the sequence  $s$  of topplings.

**Definition 1.3.** If  $u$  is an unstable configuration of the HAM on a  $\tau_q$ -map  $\mathcal{M}_q^\tau$  then we call *relaxation* of the configuration  $u$  every sequence  $s$  of topplings that transforms  $u$  into a stable configuration  $u'$ .

The relaxation process is not unique. In fact in an unstable configuration, more than one vertex could be unstable. Thus, the choice of the vertex which will topple at a time step leads to several relaxations. As mentioned in the article of Priezzhev, Dhar and al. [PDDK02], the topplings could be made in every possible order and it always leads to the same stable configuration. The relaxation process is confluent. Thus we will denote by  $\hat{u}$  the unique stable configuration that can be reached from  $u$  performing only topplings.

Starting from a configuration  $u$  we can draw the digraph  $G = (V, E)$  where  $V$  are labeled by configurations and there exists an edge  $(v, w)$  if  $w$  can be reached from  $v$  with only one toppling. If we define a partial order  $\leq$  on the set of configurations such that  $u_1 \leq u_2$  if and only if there exists a sequence  $s$  such that  $u_2 \xrightarrow{s} u_1$ .

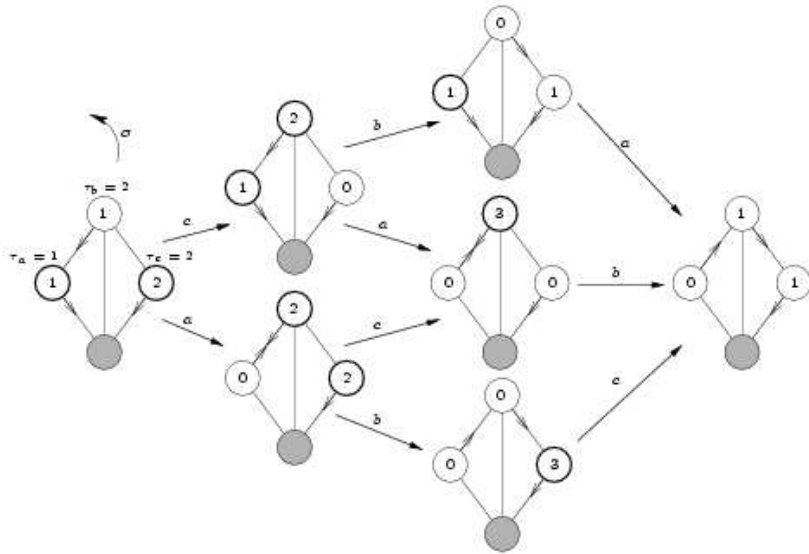

FIGURE 4. LLD lattice for  $\rightsquigarrow$  operator.

**Proposition 1.4.** *The graph  $G$  is in fact a lower locally distributive (LLD) lattice whose cover relation is the toppling relation.*

PROOF. Let  $u$  be a configuration. The shot-vector of a configuration  $u'$  such that  $u \rightsquigarrow u'$ , is the set of topplings involved in the sequence  $s$ . If we denote by  $E$  the set of configurations lower than  $u$ , i.e.  $E = \{u', u' \leq u\}$ , then it is straightforward to show that  $E$  ordered by  $\geq$  is isomorphic to the set of shot-vectors of configurations in  $E$  ordered by inclusion. Since this ordered set is an upper locally distributive lattice, the graph  $G$  which corresponds to  $(E, \geq)$  is a lower distributive lattice.  $\square$

Figure 4 is an example of the lower locally distributive (LLD) lattice associated to the relaxation of an unstable configuration.

Note that a toppling is a vectorial addition but you cannot perform it on all configurations. Toppling vertex  $i$  is allowed only if  $i$  is unstable. Thus, we define a more general toppling operation, called *forced toppling* which corresponds to the same operation but without any condition of stability. We note the repetition of this new operation by  $\curlywedge$ . Thus  $u \curlywedge v$  means that we can obtain  $v$  from  $u$  with some (forced) topplings -see figure 5-.

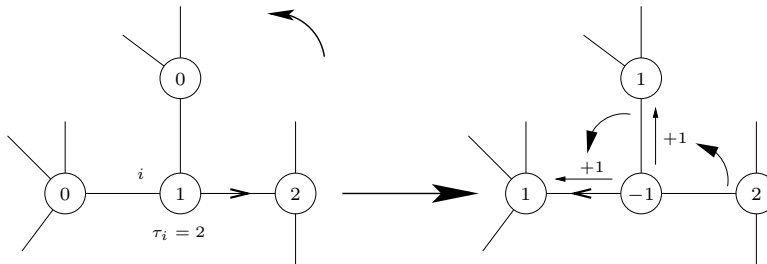

FIGURE 5. Example of a forced toppling of a stable vertex

## 2. Recurrent configurations of the HAM

### 2.1. Recurrent configurations.

**Definition 2.1.** Let  $\mathcal{C}_\omega$  be the following Markov chain:

- $(0, \omega)$  is the initial state.
- A transition is made of two steps:
  - Addition of a grain which increases the height by one on a random vertex.
  - Relaxation of the configuration.

We will denote by  $E_\omega$  the set of recurrent configurations (states) of  $\mathcal{C}_\omega$  and by  $\mathcal{E}$  the set of all recurrent configurations for all possible starting orientations.

Note that the initial state of the Markov chain is  $(0, \omega)$ . If we choose any other initial height configuration  $h$ , then the recurrent configurations associated to the Markov chain would have remained  $E_\omega$ . Indeed the stable configuration obtained after relaxation of  $(\text{Max}(h, 0), \omega)$  belongs to both Markov chains.

**2.2. Extended recurrence criterion.** In the model, for each vertex  $i$ , a natural quantity depending on  $\tau_i$  and  $d_i$  is meaningful: the *multiplicity factor*. The multiplicity factor  $\lambda_i$  is defined for each vertex  $i$  by:

$$\lambda_i = \frac{\text{lcm}(\tau_i, d_i)}{d_i} = \frac{\tau_i}{\text{gcd}(\tau_i, d_i)}$$

Then the multiplicity factor of the map is defined as  $\lambda = \text{lcm}_{i \in V} \{\lambda_i\}$ .

The factor  $\lambda_i$  corresponds for each vertex to the smallest number of times any half-edge adjacent to  $i$  is visited in order to return in the same arrow state by toppling operations. In figure 6,  $\tau_i = 2$  for the considered vertex. We must topple this vertex at least 5 times in order to return to the same orientation state. During these topplings each adjacent half-edge has been visited twice.

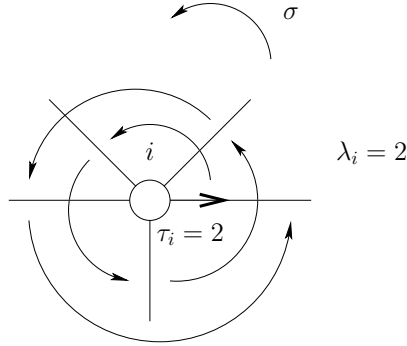

FIGURE 6. Graphical interpretation of the multiplicity factor of a vertex

**Lemma 2.2.** *Let  $u = (h, \omega)$  be a configuration of the system. Let  $s = s_1 s_2 \dots s_k$  be a series of topplings of any vertices (sink included) starting from  $u$  such that after performing toppling  $s_k$ , the system returns in configuration  $u$ . Then, in this process, each half-edge of the map is visited  $m\lambda$  times with  $m \in \mathbb{N}$ .*

PROOF. Notice that when a vertex topples, its first edge is visited, then its second one and so on, so that no edge could be visited twice before all the other ones are visited once.

Then, as the orientation of a vertex  $i$  is the same between the beginning and the end of the process, this means that each half-edge adjacent to  $i$  is visited the same number of times  $m_i \lambda_i$ .

Suppose now that there exist  $i, j$  such that  $i \neq j$  and  $m_i \lambda_i \neq m_j \lambda_j$ . Let  $i_0$  be a strict minimum for  $m_i \lambda_i$ ; there is no  $j$  such that  $m_j \lambda_j < m_{i_0} \lambda_{i_0}$  and there exists vertex  $j$  adjacent to vertex  $i_0$  such that  $m_j \lambda_j > m_{i_0} \lambda_{i_0}$ . This vertex received  $\sum_{i \text{ adjacent to } i_0} m_i \lambda_i$  grains but sends  $d_{i_0} m_{i_0}$  grains. So it topples strictly less grains than it receives which contradicts the conservation law of grains. Finally, all  $m_i \lambda_i$  are equal and so  $m_i \lambda_i = m\lambda$ .  $\square$

**Theorem 2.3.** *Let  $\mathcal{M}_q^\tau$  be a  $\tau_q$ -map. Let  $u$  be a stable configuration. Suppose that we topple  $k$  times the sink and that the relaxation of this new configuration is  $u$ . Then, the relaxation of the configuration obtained by toppling the sink  $\lambda$  times in  $u$  is  $u$ .*

PROOF. Since  $\tau_q = d_q$ , by preceding lemma,  $k = m\lambda$ . We must show that in fact taking  $m = 1$  is also possible.

Consider the following process:

Repeat  $m$  times the following two-steps operation:

- (1) Topple the sink  $\lambda$  times.
- (2) Relax the new configuration.

At the end of the process, the resulting configuration is  $u$  because of the confluence of the relaxation.

In this process we look at the series of half-edges  $s^i, 1 \leq i \leq m$  which appear in (a), (b) of the time step  $i$ . Suppose that one half-edge appears strictly more than  $\lambda$  times. Take the first one that does so. Then, it means that the corresponding vertex  $i$  received strictly more than  $\lambda d_i$  grains. Hence it received strictly more than  $\lambda$  grains along at least one half-edge. This contradicts the fact that we take the first half-edge which appears twice. Therefore each half-edge appears at most  $\lambda$  times. As at the end of the  $m^{\text{th}}$  series, every half-edge appears  $m\lambda$  times, each half-edge appears exactly  $\lambda$  times in each series  $s^i$ . Hence it is easy to check that if every half-edge appears  $\lambda$  times, the configuration obtained is the same.  $\square$

From this theorem we can now generalize Dhar's criterion [Dha90] for characterizing recurrent configurations.

**Theorem 2.4.** *[Extended recurrence criterion] A configuration  $u$  is recurrent if and only if when toppling  $\lambda$  times the sink in  $u$ , the relaxation of the new configuration gives  $u$ .*

PROOF. The proof is very straightforward.

First we can show that if there is a recurrent configuration that verifies the conditions of Theorem 2.3, then any recurrent configuration of the same orbit verifies them. Now, let consider the process of toppling the sink and relaxing. If we repeat this process starting from a recurrent configuration, we eventually find a recurrent configuration of the same orbit that verifies the condition of Theorem 2.3. Hence, any recurrent configuration satisfies the criterion.

The reciprocity is immediate by definition of recurrence.  $\square$

### 3. HAM group of recurrent configurations

**3.1. Arrow equivalent configurations.** We now classify the recurrent configurations into different classes. This classification comes from the following observations:

- In the Abelian Sandpile Model, the orientations are irrelevant. In fact  $\tau_i = d_i$  for each vertex. Thus, when you topple a vertex, the arrow makes one turn and return in the same position.
- In the Eulerian Walker problem, heights are irrelevant as they are all equal to 0 ( $\tau_i = 1$  for all vertices).

For the HAM model, we try to separate the influence and the correlation between height and orientations.

**Definition 3.1.** Let  $\omega_1$  and  $\omega_2$  be two different orientations. We say that  $\omega_1$  is equivalent to  $\omega_2$  and we write  $\omega_1 \sim_o \omega_2$  if and only if  $E_{\omega_1} = E_{\omega_2}$ .

By extension, we say that two configurations  $u_1 = (h_1, \omega_1)$ ,  $u_2 = (h_2, \omega_2)$  are arrow equivalent and we write  $u_1 \sim_o u_2$  if  $\omega_1 \sim_o \omega_2$ . Note that  $\sim_o$  is an equivalence relation.

**Lemma 3.2.** *Two configurations  $u_1 = (h_1, \omega_1)$  and  $u_2 = (h_2, \omega_2)$  are arrow equivalent on a  $\tau_q$ -map  $\mathcal{M}_q^\tau$  if and only if:*

$$\forall i \neq q, \exists k_i \in \mathbb{N}, \omega_{1,i} = \sigma^{k_i \tau_i}(\omega_{2,i})$$

PROOF. If  $u_1$  and  $u_2$  are arrow equivalent, we can get from  $u_1$  and  $u_2$  a common configuration by additions of grains and toppling operations. When adding a grain, the orientations stay the same and when toppling a vertex  $i$ , the orientation rotates by  $\sigma^{\tau_i}$ . Thus  $\omega_1$  and  $\omega_2$  respect the above property (see figure 7).

Conversly, if two configurations  $u_1$  and  $u_2$  satisfy the above property, then the stable configuration of  $(k\tau, \omega_2)$  obviously belongs to the Markov chain initiated by  $(0, \omega_2)$ , but also by the one initiated by  $(0, \omega_1)$ . Hence  $u_1$  and  $u_2$  are arrow equivalent.  $\square$

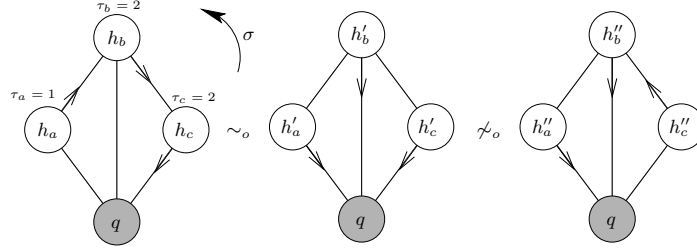

FIGURE 7. Example of arrow equivalent configurations

**3.2. HAM Abelian group.** In this part, we show how the Abelian Sandpile Group can be generalized in this new model.

**Definition 3.3.** For all vertices  $i \neq q$ , we define the set of operators  $a_i$  as the addition of a grain on vertex  $i$  followed by the relaxation.

Those operations form obviously a semigroup acting on any class of arrow equivalent configurations.

**Lemma 3.4.** *The operators commute:*

$$\forall i, j \neq q, [a_i, a_j] = 0$$

PROOF. This comes from the confluence property of topplings. If there are two different unstable vertices at a given time, then you can make the topplings in any order and the resulting stable configurations are the same.  $\square$

**Theorem 3.5.** *Let  $\omega$  be an orientation, the operators  $\{a_i\}_{i \neq q}$  form an Abelian group called HAM group acting on  $E_\omega$ . We have the following relations:*

$$\forall i, a_i^{\lambda_i d_i} = \prod_{\{i,j\} \in E} a_j^{\lambda_i}$$

PROOF. By Theorem 2.4 and the extended recurrence criterion, it is clear that  $a_i$  is invertible when acting on  $E_\omega$ .

If  $\Delta$  is the Laplacian matrix of the graph  $(V, E)$  associated to the map, then:

$$\forall i \neq q, \prod_{j \neq q} a_j^{\lambda_i \Delta_{i,j}} = I \quad [r_i].$$

Moreover, any relations between operators can be expressed in terms of  $r_i$ . Each one corresponds to the toppling of a vertex.  $\square$

Now, we study the repartition of the recurrent configurations between classes  $E_\omega$ . Thus, we define the graph  $W$  to be the directed graph where:

- Vertices are recurrent configurations.
- Edges are the application of operator  $a_i$  or  $a_i^{-1}$ .

**Lemma 3.6.** *The graph  $W$  is the graph whose connected components are the equivalence classes of the relation  $\sim_o$  restricted to  $\mathcal{E}$ .*

The above lemma is the direct consequence of the following one.

**Lemma 3.7.** *Let  $u$  and  $u'$  two recurrent configurations. They are connected within  $W$  (i.e., there is a sequence of  $a_i$ 's, such that  $(\prod_{i \in \mathcal{I}} a_i)u = u'$ ) if and only if there is an orientation  $\omega$  such that  $u$  and  $u'$  are in  $E_\omega$ .*

PROOF. Since  $\mathcal{G} = \langle a_i, r_i \rangle$  is a group acting on  $\mathcal{E}$ , the connected components of  $W$  are the same as the ones of the graph obtained from  $W$  by deleting the edges  $a_i^{-1}$ . Hence we restrict ourselves to this graph.

Since  $u$  is recurrent, there is an orientation  $\omega$  such that  $u$  is in  $E_\omega$ .

Suppose that  $u$  and  $u'$  are connected within  $W$ . Then we can write  $u' = (\prod_{i \in \mathcal{I}} a_i)u$ . Hence  $u'$  can be obtained by beginning the Markov chain by the configuration  $(0, \omega)$  i.e.,  $u' \in E_\omega$ .

Suppose that both  $u$  and  $u'$  are in  $E_\omega$ . Then they are recurrent in the Markov chain beginning by  $(0, \omega)$ . Thus, there is a vector  $g$  such that when we add  $g_i$  grains to each vertex  $i$  of configuration  $u$  and relax, we get  $u'$ . It means that  $(\prod_i a_i^{g_i})u = u'$  i.e.,  $u$  is connected to  $u'$  in  $W$ . By inversibility, we get the fact that  $u'$  is connected to  $u$  in  $W$ .  $\square$

**Theorem 3.8.** *Let  $\omega$  be an orientation. Then the recurrent configurations in  $E_\omega$  are equiprobable.*

PROOF. The transition matrix of the associated Markov chain is irreducible by Lemma 3.6. Hence there exists a unique stationary probability. Since the equiprobability is obviously valid, it is the solution.  $\square$

**Eulerian Walker :** In the Eulerian Walker,  $\tau_i = 1$  for all vertices. Thus there is only one possible height function which is 0 everywhere. In this case, there is only one equivalence class -one connected component in  $W$ - for  $\sim_o$ .

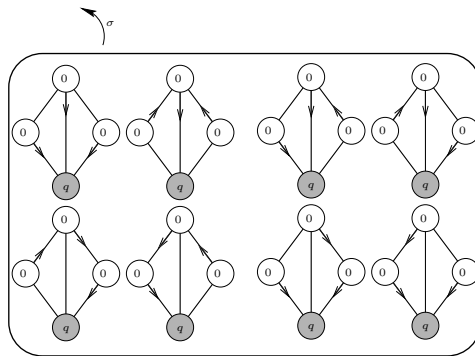

FIGURE 8. Equivalence classes for  $\sim_o$  in the EWM.

**Abelian Sandpile Model (ASM) :** In the ASM,  $\tau_i = d_i$  for all vertices. Thus all configurations in a class have the same orientations for the vertices.

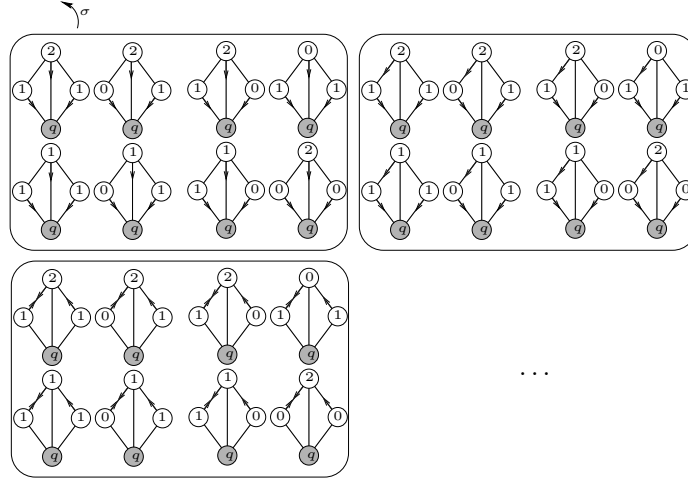

FIGURE 9. Equivalence classes of  $\sim_o$  for the ASM.

Notice that all classes have equal cardinality. We denote by  $\Delta$  the Laplacian matrix of the underlying graph, and by  $\Delta^q$  its  $q$ -minor, i.e. where row and column  $q$  are removed.

**Proposition 3.9.** *The HAM group  $\mathcal{G} = \langle a_i; r_i \rangle$  is the one associated to the matrix  $(\lambda_i \Delta_i^q)_i$  with  $i \neq q$ . Then  $|E_\omega| = |\mathcal{G}| = (\prod_i \lambda_i) |\det(\Delta^q)|$ . The number of spanning trees of the underlying graph is  $|\det(\Delta^q)|$ .*

Moreover,  $|\mathcal{E}| = \xi |\mathcal{G}|$  where  $\xi = \prod_{i \neq q} \gcd(\tau_i, d_i)$  i.e.

$$|\mathcal{E}| = \left( \prod_i d_i \right) |\det(\Delta^q)| = \xi |\mathcal{G}|.$$

PROOF. From the above remarks,  $(\lambda_i \Delta_i^q)_i$  with  $i \neq q$  is the matrix of the group  $\mathcal{G}$ . Hence  $|\mathcal{G}| = \det(\lambda_i \Delta_i^q), i \neq q$ , and we get the result by multilinearity of the determinant.

We can also directly guess that every  $E_\omega$  have the same cardinality because such a set is the result of the action of a group on a configuration.

The fact that  $|\det(\Delta^q)|$  is the number of spanning trees of the underlying graph comes from the matrix-tree theorem [WVL92].

□

#### 4. Extended properties

We saw in the last section an equivalence relation among configurations. The relation helps us to determine the cardinality of the set of recurrent configurations. We now define some other relations in order to build a natural addition on recurrent configurations like in the ASM. In the ASM, the anti-toppling of a vertex is equivalent to the toppling of all the other vertices. In the HAM, this relation is sometimes false. When  $\lambda \neq 1$  the behaviour of the HAM differs from the ASM. Thus, we introduce two different equivalence relations, the first one  $\sim_t$  which is the ASM equivalence and the second one  $\sim_q$  where the factor  $\lambda$  is relevant.

##### 4.1. Toppling equivalence $\sim_t$ .

**Definition 4.1.** Let  $u = (h, \omega)$  and  $u' = (h', \omega')$  be two configurations. We say that  $u$  and  $u'$  are toppling equivalent, and we note  $u \sim_t u'$  if and only if  $u$  can be obtained from  $u'$  by a sequence of (forced) topplings and anti-topplings of any vertex.



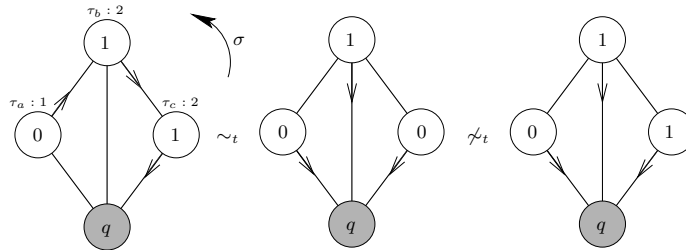

FIGURE 10. The last configuration is not toppling equivalent with the two others, but obviously arrow equivalent with them.

As we mentioned above, this relation is finer than  $\sim_o$ . It corresponds to the classical equivalence relation on the Abelian Sandpile Model. In the ASM, there is only one recurrent configuration in each equivalence class.

In the following this result is extended to the HAM.

**Proposition 4.2.**  $\sim_t$  is an equivalence relation on the set of all configurations. Moreover,  $\sim_t \implies \sim_o$ .

PROOF. The fact that  $\sim_t$  is transitive, reflexive and symmetric is obvious. From Definition 4.1, if  $u \sim_t u'$ , then:

$$\exists k, \forall i, \omega_i = \sigma^{k_i \tau_i}(\omega'_i).$$

In particular it means that  $\omega \sim_o \omega'$  i.e.,  $u \sim_o u'$ . □

A direct corollary of Theorem 2.4 is the following proposition:

**Proposition 4.3.** The equivalence classes of  $\sim_t$  have same cardinality  $\lambda$ .

Thus we can define a finer (if  $\lambda > 1$ ) equivalence relation:

**Definition 4.4.** Let  $u = (h, \omega)$  and  $u' = (h', \omega')$  be two configurations. We say that  $u$  and  $u'$  are *sink equivalent*, and we note  $u \sim_q u'$  if and only if  $u$  can be obtained from  $u'$  by a sequence of (forced) topplings and anti-topplings of any vertex except  $q$ .

This relation is more restrictive than  $\sim_t$ . If  $\omega$  is an orientation of a  $\tau_q$ -map then we denote by  $\mathcal{P}^q(u)$  the equivalence class of  $u$  for  $\sim_q$ .

**Proposition 4.5.**

$$\sim_q \implies \sim_t \implies \sim_o$$

We also have the converse relation for inclusion of equivalence classes.

Moreover,  $\lambda = 1 \iff \sim_q = \sim_t$

PROOF. The first inclusions are straightforward from the definition of equivalence relations.

The second point is a corollary of the following fact: toppling  $\lambda$  times the sink  $q$  is rigorously equivalent to anti-toppling  $\frac{\lambda d_i}{\tau_i}$  times vertex  $i$  for all vertices  $i$  except  $q$ . Since there do not exist  $k < \lambda$  such that toppling  $k$  times the sink is equivalent to toppling other vertices,  $\sim_t$  and  $\sim_q$  correspond to the same equivalence relation if and only if  $\lambda = 1$ .

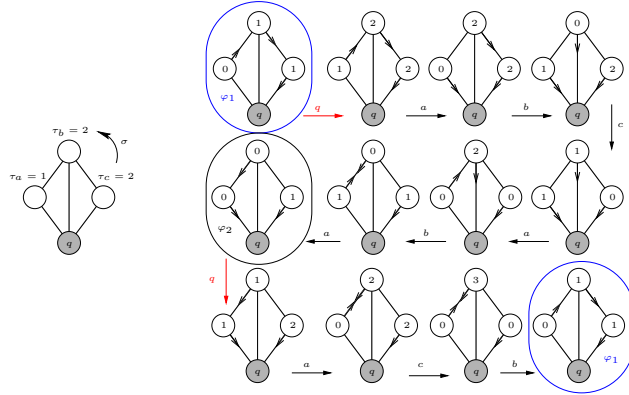

FIGURE 11. Non equivalence between  $\sim_t$  and  $\sim_q$ .

□

If  $u$  and  $u'$  are two configurations. Then they are sink equivalent if and only if  $u$  can be obtained from  $u'$  by a sequence of topplings of any vertices with the restriction that the sink  $q$  is toppled  $k\lambda$  times for some integer  $k$ .

The proof is quite straightforward. From Theorem 2.4, we can express the anti-toppling of any vertex  $i$  in term of topplings of vertices. If every vertex topples  $d_i\lambda/\tau_i$  times except vertex  $i$  that topples  $d_i\lambda/\tau_i - 1$  times, then it is as if the vertex  $i$  anti-topples. Hence if  $u \sim_q u'$ ,  $u$  can be obtained from  $u'$  by a sequence of topplings of vertices with the restriction that the sink  $q$  can only topples a number of times multiple of  $\lambda$ .

This last remark proves that there is only one recurrent configuration in each equivalence class of  $\sim_q$ .

**Proposition 4.6.**

$$|E_\omega / \sim_q| = |E_\omega|$$

From these remarks on  $\sim_q$  arises a natural order on configurations noted  $\succ_q$ .

**Definition 4.7.** Let  $u$  and  $u'$  be two configurations. We say that  $u \succ_q u'$  if  $u'$  could be obtained from  $u$  with a series of (forced) topplings of vertices ( $\neq q$ ).

This order is a partial order on the infinite set of configurations of the HAM. Moreover, any class  $\mathcal{P}^q(u)$  is an infinite distributive lattice for this order. If we denote by  $u_1, \dots, u_\lambda$  the  $\lambda$  distinct recurrent configurations of a class for  $\sim_t$ , then each one belongs to a different class for  $\sim_q$ . We go from one class to the other by toppling  $q$  (cf figure 12).

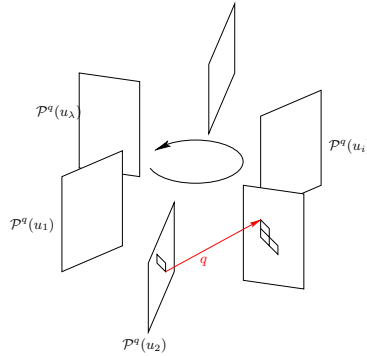

FIGURE 12. A class of  $\sim_t$  splits into  $\lambda$  classes  $\mathcal{P}^q(u)$  of  $\sim_q$ .

**4.2. Extended burning algorithm.**

**Theorem 4.8.** *Let  $u$  be a configuration. Then there exists a unique recurrent configuration  $u'$  sink-equivalent to  $u$ . This configuration is the fixed point of the following process:*

- (1) *Topple  $\lambda$  times the sink in  $u$ .*
- (2) *Relax the configuration obtained.*

We call this process extended burning algorithm (see figure 13).

Moreover if  $u$  is non-negative then the number of iterations of the previous process is bounded by a characteristic factor of  $\mathcal{M}_q^T$ .

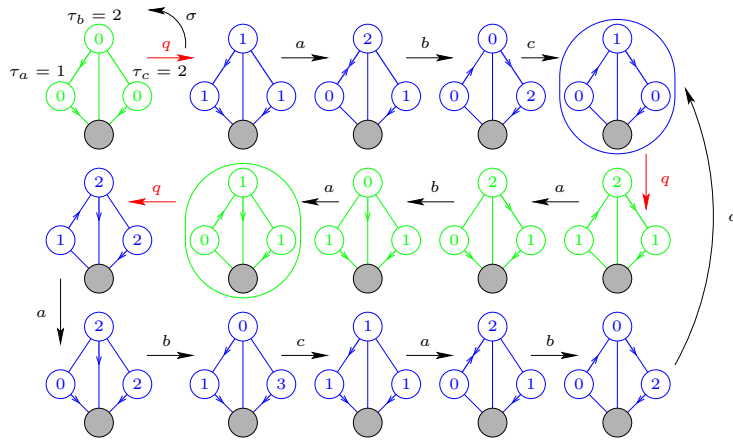

FIGURE 13. Extended burning algorithm

**4.3. Addition.** We now define an addition for recurrent configurations. The main problem between HAM and ASM is that the orientations could be different between two recurrent configurations.

So let  $\omega$  be an orientation We call  $\omega$ -representation of the configuration  $u = (h, \omega_1)$  the configuration  $u' = (h', \omega)$  obtained from  $u$  by anti-toppling each vertex  $i$  the smallest number of times to obtain the same orientation as  $\omega$ . If  $u = (h, \omega)$  and  $u' = (h', \omega)$  are two recurrent configurations. Their  $\omega$ -addition is the relaxation of the configuration  $(h + h', \omega)$ .

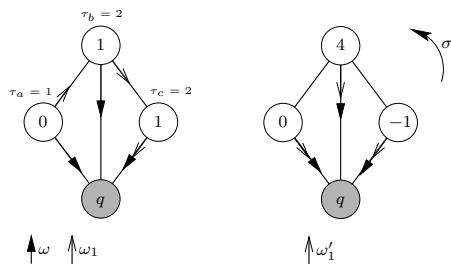

FIGURE 14.  $\omega$ -representation

**Definition 4.9.** Let  $u, u'$  be two recurrent configurations of  $E_\omega$ . We define the  $\omega$ -addition  $u \oplus_\omega u'$  of the two configurations as the recurrent configuration sink-equivalent to the sum of the  $\omega$ -representation of  $u$  and  $u'$ .

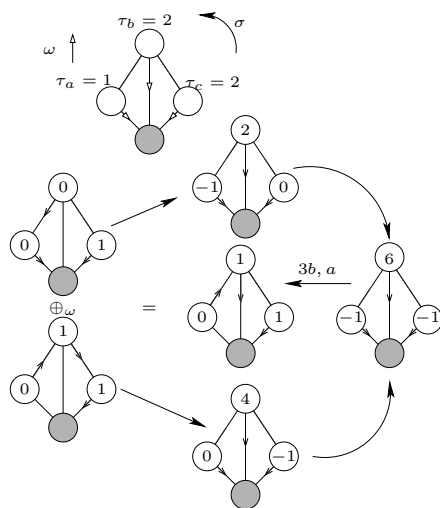

FIGURE 15. Exemple of addition

Note that this definition is coherent because there exists a unique recurrent configuration sink-equivalent to a configuration. For example, the identity of  $(E_\omega, \oplus_\omega)$  is the unique recurrent configuration sink-equivalent to  $(0, \omega)$  which can be obtained by the extended burning algorithm.

## 5. Conclusion

In this article we make an extensive study of the so-called Height Arrow Model. We show how the classical results of the Eulerian Walker and of the Abelian Sandpile Model could be generalized. Moreover, we find the cardinality of the set of recurrent configurations of the HAM but the proofs are analytic. It is possible to generalize the bijections between recurrent configurations and spanning trees as those found by Dhar.

## References

- [Big96] N. L. Biggs, *Chip-firing on distance-regular graphs*, Tech. Report LSE-CDAM-96-11, CDAM Research Report Series (1996).
- [Big99] ———, *Chip-firing and the critical group of a graph*, Journal of Algebraic Combinatorics **9** (1999), no. 1, 25–45.
- [BTW87] P. Bak, C. Tang, and K. Wiesenfeld, *Self-organized criticality: an explanation of  $1/f$  noise*, Phys. Rev. Lett. **59** (1987).
- [CGB02] S. Corteel and D. Gouyou-Beauchamps, *Enumeration of sand piles*, Discr. Math. **256** (2002), no. 3, 625–643.
- [CM92] R. Cori and A. Machi, *Maps, hypermaps and their automorphisms: a survey, i*, Expo. Math. **10** (1992), 403–427.
- [CR00] R. Cori and D. Rossin, *On the sandpile group of dual graphs*, European J. Combin. **21** (2000), no. 4, 447–459.
- [Dha90] D. Dhar, *Self-organized critical state of sandpile automaton models*, Physical Review Letters **64** (1990), 1613–1616.
- [DM91] D. Dhar and S. N. Majumdar, *Height correlations in the abelian sandpile model*, Journal of Physics A **24** (1991), 357–362.
- [DRSV95] D. Dhar, P. Ruelle, S. Sen, and D. Verma, *Algebraic aspects of abelian sandpile models*, Journal of Physics A **28** (1995), 805–831.
- [PDDK02] V B Priezzhev, D. Dhar, A Dhar, and S Krishnamurthy, *Eulerians walkers as a model of self-organized criticality*, Arxiv (2002).
- [WVL92] R.M. Wilson and J.H. Van Lindt, *A course in combinatorics*, Cambridge University Press, 1992, 449-460.

LIX, ECOLE POLYTECHNIQUE, ROUTE DE SACLAY, 91128 PALAISEAU CEDEX FRANCE  
*E-mail address:* `dartois@lix.polytechnique.fr`

LIAFA, UNIVERSITÉ PARIS 7, 2, PLACE JUSSIEU, CASE 7014, 75251 PARIS CEDEX  
*E-mail address:* `rossin@liafa.jussieu.fr`



## A combinatorial approach to jumping particles I: maximal flow regime

Enrica Duchi and Gilles Schaeffer

**Abstract.** *In this paper we consider a model of particles jumping on a row of cells, called in physics the one dimensional totally asymmetric exclusion process (TASEP). More precisely we deal with the TASEP with two or three types of particles, with or without boundaries, in the maximal flow regime. From the point of view of combinatorics a remarkable feature of these Markov chains is that they involve Catalan numbers in several entries of their stationary distribution.*

*We give a combinatorial interpretation and a simple proof of these observations. In doing this we reveal a second row of cells, which is used by particles to travel backward. As a byproduct we also obtain an interpretation of the occurrence of the Brownian excursion in the description of the density of particles on a long row of cells.*

**Résumé.** *Dans cet article, nous étudions un modèle de particules qui sautent le long d'une ligne, appelé en physique le processus d'exclusion totalement asymétrique unidimensionnel (TASEP). Plus précisément, nous traitons le TASEP avec deux ou trois types de particules, avec ou sans bords, dans le régime de flux maximal. D'un point de vue combinatoire, une propriété remarquable de ces chaînes de Markov est qu'elles font intervenir des nombres de Catalan dans plusieurs entrées de leur distribution stationnaire.*

*Nous donnons une interprétation combinatoire et une preuve simple de ces observations. Ce faisant, nous révélons une deuxième rangée de cases, utilisées par les particules pour retourner en arrière. Nous en déduisons enfin une interprétation de l'apparition d'excursion Brownienne dans la description de la densité des particules le long d'une longue rangée de cases.*

### 1. Jumping particles

**1.1. The basic model.** We shall consider a model of jumping particles on a row of  $n$  cells that was studied since the early 90's in physics under the name *one dimensional totally asymmetric exclusion process with boundaries*, or TASEP for short. Although the model is usually presented as a continuous time evolution, it is equivalent, and it is more convenient for us, to define it in discrete time as a Markov chain  $S^0$  on a set of basic configurations:

- A *basic configuration* is a row of  $n$  cells, separated by  $n + 1$  walls (the leftmost and rightmost ones are borders). Each cell is occupied by one particle, and each particle has a type, black or white (see Figure 1).
- At time  $t = 0$ , the system is in a basic configuration  $S^0(0)$  (possibly chosen at random).

---

1991 *Mathematics Subject Classification.* Primary 05A15 ; Secondary 60J05 .

*Key words and phrases.* bijections, markov chains, Catalan numbers, non equilibrium statistical physics.

The first author was supported by a grant of the city council of Paris, and the second by EC's IHRP Program, within the Research Training Network *Algebraic Combinatorics in Europe*, grant HPRN-CT-2001-00272.

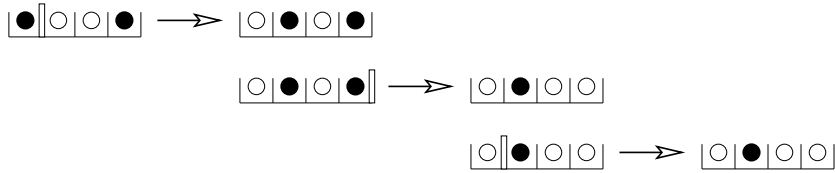
FIGURE 1. A basic configuration with  $n = 10$  cells.FIGURE 2. An example of evolution, with  $n = 4$ . The active wall triggering each transition is indicated.

- From time  $t$  to  $t+1$ , the system evolves from the basic configuration  $S^0(t)$  to the basic configuration  $S^0(t+1)$  as follows: an active wall is chosen uniformly at random among the  $n+1$  walls and four cases arise. The complete model for  $n=3$  is presented in Appendix B (see Figure 19).
  - a. If the active wall separates a black particle (on its left) and a white particle (on its right), then the two particles swap.
  - b. If the active wall is the left border and the leftmost cell contains a white particle, then the white particle leaves the system and it is replaced by a black particle.
  - c. If the active wall is the right border and the rightmost cell contains a black particle, then the black particle leaves the system and it is replaced by a white particle.
  - d. Otherwise nothing happens:  $S^0(t+1) = S^0(t)$ .

As illustrated by Fig. 2, black particles travel from left to right, while white particles do the opposite. Equivalently one can view white particles as empty cells. Derrida *et al.* [DDM92, DEHP93] proved the following nice results about the evolution of the system  $S^0$  after a long time. First,

$$(1.1) \quad \text{Prob}(S^0(t) \text{ contains } 0 \text{ black particles}) \xrightarrow{t \rightarrow \infty} \frac{1}{C_{n+1}},$$

where  $C_{n+1} = \frac{1}{n+2} \binom{2n+2}{n+1}$  is the  $(n+1)$ th Catalan number. More generally, for all  $0 \leq k \leq n$ ,

$$(1.2) \quad \text{Prob}(S^0(t) \text{ contains } k \text{ black particles}) \xrightarrow{t \rightarrow \infty} \frac{\frac{1}{n+1} \binom{n+1}{k} \binom{n+1}{n-k}}{C_{n+1}},$$

where the numerators are called Narayana numbers.

The model is a finite state Markov chain which is clearly ergodic so that the previous limits are in fact the probabilities of the same events in the unique stationary distribution of the chain [HÖ2]. More generally, Derrida *et al.* provided expressions for the stationary probabilities. Since their original work a number of papers have appeared providing alternative proofs and further results on correlations, time evolutions, etc. It should be moreover stressed that the model we presented is a special case among the many existing variants of asymmetric exclusion processes. In particular we have restricted our attention here to the maximal flow regime, where particles enter, travel and exit at the same rate (see however [DS04] for an extension of the present work to general rates). Recent advances and a bibliography can be found for instance in the article [DLS03]. Books about particle processes are [Spo91, Lig85]. However, the remarkable apparition of Catalan numbers is not easily understood from the proofs in the physics literature. As far as we know, these proofs rely either on a *matrix ansatz*, or on a *Bethe ansatz*, both being then proved by a recursion on  $n$ .

We propose here a combinatorial derivation of these stationary probabilities. In fact we deal with a slightly more general model, the three particle TASEP [And88, DEHP93]. This model is a Markov chain  $S$  that extends  $S^0$  to three kinds of particles:



- A basic configuration is a row of  $n$  cells, separated by  $n + 1$  walls (the leftmost and rightmost ones are borders). Each cell is occupied by one particle. Each particle has a type,  $\bullet$  (black),  $\times$ , or  $\circ$  (white), and these three types are ordered:  $\bullet > \times > \circ$ .



FIGURE 3. A basic configuration with  $n = 14$  cells.

- At each step, together with the selection of the active wall, a choice is made between two transition rules  $\theta$  and  $\theta'$ , with equal probability. Then four cases arise:
  - The active wall separates two particles such that the type of the left one is larger than the type of the right one. Then the two particles swap. In other terms, the possible local transitions around the active wall are  $(\bullet|\circ \rightarrow \circ|\bullet)$ ,  $(\bullet|\times \rightarrow \times|\bullet)$ , and  $(\times|\circ \rightarrow \circ|\times)$ .
  - The active wall is the left border. If the leftmost particle is white then it exits, and it is replaced by a black or an  $\times$  particle when the rule is respectively  $\theta$  or  $\theta'$ . If instead it is an  $\times$  particle and the rule is  $\theta'$ , then it exits and is replaced by a black particle.
  - The active wall is the right border. If the rightmost particle is black then it exits, and gets replaced by a white or an  $\times$  particle when the rule is respectively  $\theta$  or  $\theta'$ . If instead it is an  $\times$  particle and the rule is  $\theta'$ , then it exits and is replaced by a white particle.
  - Otherwise nothing happens.

An example of evolution is given in Figure 4. One possible interpretation of this model is that black and white particles still travel respectively to the right and to the left, while  $\times$  particles act as empty cells. Another interpretation is with white particles standing for vacancies and black particles overtaking slower  $\times$  particles.

**1.2. The complete model.** Our main ingredient to study the three particle TASEP consists in the construction of a new Markov chain  $X$  on a set  $\Omega_n$  of *complete configurations* that satisfies two main requirements: on the one hand the stationary distribution of the basic chain  $S$  can be simply expressed in terms of that of the chain  $X$ ; on the other hand the stationary behavior of the chain  $X$  is easy to understand. The complete configurations that we introduce for this purpose are made of two rows of  $n$  cells containing black,  $\times$ , and white particles. The first requirement is met by imposing that disregarding what happens in the second row, the chain  $X$  simulates the chain  $S$  in the first row. The second requirement is met by adequately choosing the complete configurations and the transition rules so that  $X$  clearly has a uniform stationary distribution.

More precisely a pair of rows of particles belongs to  $\Omega_n$  if: (i) the  $\times$  particles appear in pairs to form  $|\times|$ -columns, thus delimiting *blocks* of contiguous black and white particles; (ii) each of these blocks contains an equal number of black and white particles; (iii) inside each block, to the left of any vertical wall there are no more white particles than black ones (the *positivity condition*).

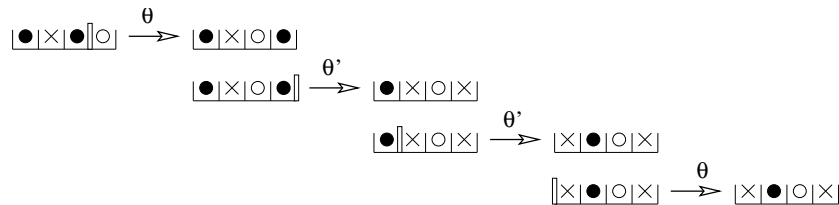

FIGURE 4. An example of evolution with  $n = 4$  for the three particle model.

An example of a complete configuration is given in Figure 5: from left to right the blocks have successively length 3, 0, 1, and 7. In Section 2 we prove that the cardinality of  $\Omega_n$  is  $\frac{1}{2}\binom{2n+2}{n+1}$ , and that, for any  $k + \ell + m = n$ , the cardinality of the set  $\Omega_{k,m}^\ell$  of complete configurations with  $\ell$   $|\times|_\times$ -columns, and  $k$  black and  $m$  white particles on the top row is  $\frac{\ell+1}{n+1}\binom{n+1}{k}\binom{n+1}{m}$ .



FIGURE 5. A complete configuration with  $n = 14$ .

The Markov chain  $X$  on  $\Omega_n$  is defined in terms of two transition rules,  $T$  and  $T'$ , from the set  $\Omega_n \times \{0, \dots, n\}$  to the set  $\Omega_n$ , that respectively extend the transition rules  $\theta$  and  $\theta'$ . These transition rules are derived in Section 3 from two fundamental bijections  $\bar{T}$  and  $\bar{T}'$  but can be conveniently described as follows. Given a complete configuration  $\omega$  and an active wall  $i$ , the actions of  $T$  and  $T'$  on the top row of  $\omega$  do not depend on the second row, and mimic the actions of  $\theta$  and  $\theta'$  as defined by cases  $a, b, c$  and  $d$  of the description of the three particle TASEP. In particular in the top row, black particles travel from left to right and white particles from right to left. As opposed to that, in the bottom row,  $T$  and  $T'$  move black and white particles backward. In order to describe this, we first introduce the concept of sweep (see Figure 6):

- A *white sweep* between walls  $i_1$  and  $i_2$  consists in all white particles of the bottom row and between walls  $i_1$  and  $i_2$  simultaneously hopping to the right (some black particles thus being displaced to the left in order to fill the gaps). For well definiteness a white sweep between  $i_1$  and  $i_2$  can occur only if the particle on the right hand side of  $i_2$  is black.
- A *black sweep* between walls  $i_1$  and  $i_2$  consists in all black particles of the bottom row and between walls  $i_1$  and  $i_2$  simultaneously hopping to the left (some white particles thus being displaced to the right in order to fill the gaps). For well definiteness a white sweep between  $i_1$  and  $i_2$  can occur only if the particle on the left hand side of  $i_1$  is white.

Next, around the active wall  $i$ , we distinguish the following walls: if  $i \neq 0$ , let  $j_1 < i$  be the leftmost wall such that there are only white particles in the top row between walls  $j_1$  and  $i - 1$ ; if  $i \neq n$ , let  $j_2 > i$  be the rightmost wall such that there are only black particles in the top row between walls  $i + 1$  and  $j_2$ . With these definitions, we are in the position to describe the actions of  $T$  and  $T'$  on the bottom row of a configuration. First whenever an  $\times$  particle jumps in the top row, the  $\times$  particle below must follow it (so that they remain in the same column). Then the cases  $a, b$  and  $c$  of the transition rules  $\theta$  and  $\theta'$  are complemented in the bottom row as follows:

- The moves in the bottom row depend on the transition at the active wall  $i$  in the top row (these moves are illustrated by Figures 7–8, and more precisely described in Figures 11–16):
  - $(\times|\circ \rightarrow \circ|\times)$ : the  $|\times|_\times$ - and  $|\circ|_\circ$ -columns get exchanged and then a white sweep occurs between walls  $j_1$  and  $i - 1$ .

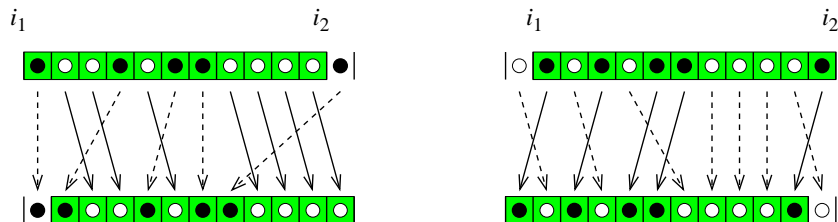

FIGURE 6. A white sweep and a black sweep.

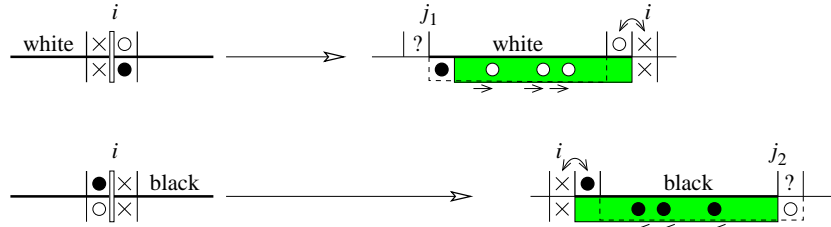

FIGURE 7. Sweeps occurring below transitions  $(\times|\circ \rightarrow \circ|\times)$  and  $(\bullet|\times \rightarrow \times|\bullet)$ .

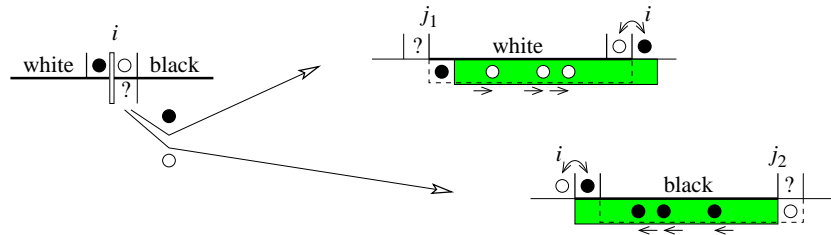

FIGURE 8. Sweeps occurring below the transition  $(\bullet|\circ \rightarrow \circ|\bullet)$ .

- $(\bullet|\times \rightarrow \times|\bullet)$ : the  $|\bullet|$ - and  $|\times|$ -columns get exchanged and then a black sweep occurs between walls  $i + 1$  and  $j_2 + 1$  (or between  $i + 1$  and  $j_2$  if  $j_2 = n$  or the particle on the right hand side of  $j_2$  is a  $\times$ ).
  - $(\bullet|\circ \rightarrow \circ|\bullet)$ : depending whether the particle on the bottom right of the  $i$ th wall in  $\omega$  is white or black, a white sweep occurs between  $j_1$  and  $i - 1$ , or a black one between  $i + 1$  and  $j_2 + 1$  (or between  $i + 1$  and  $j_2$  if  $j_2 = n$  or the particle on the right hand side of  $j_2$  is a  $\times$ ).
- b. If the entering particle is black, a black sweep occurs between the left border and wall  $j_2 + 1$ .
- c. If the entering particle is white, a white sweep occurs between wall  $j_1$  and the right border.

Otherwise nothing else happens in the bottom row. Based on  $T$  and  $T'$ , the Markov chain  $X$  is defined in a similar way as the three particle TASEP:

- The set of configurations is the set  $\Omega_n$  of complete configurations of length  $n$ .
- From time  $t$  to  $t + 1$ , the system evolves from the complete configuration  $X(t)$  to the next one  $X(t + 1)$  as follows: an active wall  $i$  is chosen uniformly at random among the  $n + 1$  walls, and one of the two rules  $T$  and  $T'$  is selected at random with probability  $1/2$ . The configuration  $X(t + 1)$  is obtained by applying the selected rule to  $X(t)$  at the active wall.

In Section 4, we shall prove that there exists an evolution between any two configurations, i.e., that the Markov chain  $X$  is irreducible. There is also a positive probability to stay in any configuration, so that it is aperiodic. Our main result is then the following theorem.

**Theorem 1.1.** *The Markov chain  $X$  has a uniform stationary distribution.*

The uniformity of the stationary distribution is obtained “by construction”: indeed, in Section 3 we show  $T$  (and similarly  $T'$ ) can be described more explicitly as the first component  $\Omega_n \times \{0, \dots, n\} \rightarrow \Omega_n$  of a bijection  $\bar{T}: \Omega_n \times \{0, \dots, n\} \rightarrow \Omega_n \times \{0, \dots, n\}$ ; then assuming that at some time  $t$  the system is in the uniform distribution on  $\Omega_n$ , i.e.,

$$\text{Prob}(X(t) = \omega) = \frac{1}{|\Omega_n|},$$

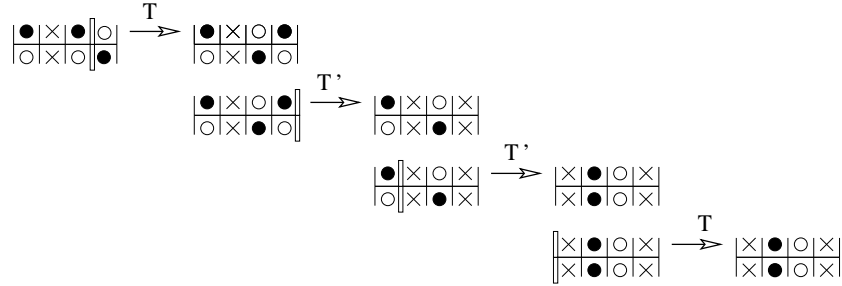

FIGURE 9. An example of evolution with  $n = 4$  for the complete three particle model.

it always remains in the uniform distribution:

$$\begin{aligned}
 \text{Prob}(X(t + 1) = \omega) &= \\
 &= \frac{1}{2} \sum_{(\omega', i) \in T^{-1}(\omega)} \text{Prob}(X(t) = \omega') \cdot \frac{1}{n+1} \\
 &\quad + \frac{1}{2} \sum_{(\omega'', i) \in T'^{-1}(\omega)} \text{Prob}(X(t) = \omega'') \cdot \frac{1}{n+1} \\
 &= \frac{1}{2} \cdot |T^{-1}(\omega)| \cdot \frac{1}{|\Omega_n|} \cdot \frac{1}{n+1} + \frac{1}{2} \cdot |T'^{-1}(\omega)| \cdot \frac{1}{|\Omega_n|} \cdot \frac{1}{n+1} = \frac{1}{|\Omega_n|},
 \end{aligned}$$

where  $T^{-1}(\omega)$  and  $T'^{-1}(\omega)$  denote the sets of preimages of  $\omega$  respectively by  $T$  and  $T'$ ; the last equality follows from the facts that  $T^{-1}(\omega) = \{\bar{T}^{-1}(\omega, j) \mid j = 0, \dots, n\}$  and  $T'^{-1}(\omega) = \{\bar{T}'^{-1}(\omega, j) \mid j = 0, \dots, n\}$ , and that  $\bar{T}$  and  $\bar{T}'$  are bijections.

**1.3. From the complete to the basic model.** According to the theory of finite state Markov chains [HÖ2], Theorem 1.1 ensures that for any choice of initial condition  $X(0)$ ,

$$\text{Prob}(X(t) = \omega) \xrightarrow{t \rightarrow \infty} \frac{1}{|\Omega_n|} = \frac{1}{\frac{1}{2} \binom{2n+2}{n+1}}.$$

This result is sufficient to recover the stationary distribution of the basic model. Indeed observe that by construction hiding the bottom row in the complete model exactly yields the basic model. Hence we obtain the following combinatorial interpretation for the stationary distribution of the three particle TASEP:

**Theorem 1.2.** *Let  $\text{top}(\omega)$  denote the top row of a complete configuration  $\omega$ . Then for any initial configurations  $S(0)$  and  $X(0)$  with  $\text{top}(X(0)) = S(0)$ , and any basic configuration  $r$ ,*

$$\text{Prob}(S(t) = r) = \text{Prob}(\text{top}(X(t)) = r) \xrightarrow{t \rightarrow \infty} \frac{|\{\omega \in \Omega_n \mid \text{top}(\omega) = r\}|}{|\Omega_n|}.$$

In particular, for any  $k + \ell + m = n$ , we obtain combinatorially the formula:

$$\text{Prob}(S(t) \text{ contains } k \text{ black and } m \text{ white particles}) \xrightarrow{t \rightarrow \infty} \frac{|\Omega_{k,m}^\ell|}{|\Omega_n|} = \frac{\frac{\ell+1}{n+1} \binom{n+1}{k} \binom{n+1}{m}}{\frac{1}{2} \binom{2n+2}{n+1}}.$$

As discussed in Section 5 this interpretation sheds a new light on some recent results of Derrida *et al.* connecting the TASEP to Brownian excursions [DEL].

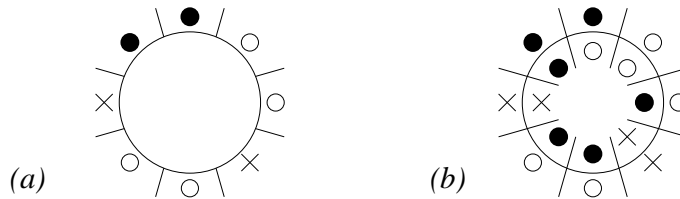

FIGURE 10. A basic (a) and a complete (b) configuration for the three particle TASEP on a circle

**1.4. Two variations.** Let us denote by  $\Omega_n^0$  the subset of configurations of  $\Omega_n$  without  $\times$  particles, and recall that  $\Omega_{k,m}^0$  is the subset of configurations of  $\Omega_n^0$  with  $k$  black and  $m$  white particles in the first row. In Section 2 we show that  $|\Omega_n^0| = \frac{1}{n+1} \binom{2n+2}{n}$  and that  $|\Omega_{k,m}^0| = \frac{1}{n+1} \binom{n+1}{k} \binom{n+1}{m}$ . As we did for  $\Omega_n$ , we define a Markov chain on the set  $\Omega_n^0$  whose evolution is determined just by the application of  $T^0$ , which is the restriction of  $T$  to the subset  $\Omega_n^0$ . The behavior of the first row in this Markov chain then exactly mimics the basic TASEP with two particles. Moreover, the associated application  $\bar{T}^0$  is a bijection from  $\Omega_n^0 \times \{0, \dots, n\}$  into itself, so that the uniform distribution is again stationary for this Markov chain. Finally it is also an ergodic Markov chain. Therefore

$$\text{Prob}(X^0(t) = \omega) \xrightarrow[t \rightarrow \infty]{} \frac{1}{|\Omega_n^0|},$$

and the stationary distribution of the two particles TASEP is combinatorially expressed as

$$\text{Prob}(S^0(t) = r) \xrightarrow[t \rightarrow \infty]{} \frac{|\{\omega \in \Omega_n^0 \mid \text{top}(\omega) = r\}|}{|\Omega_n^0|}.$$

The results (1.1)-(1.2) are then immediate consequences. The basic and complete system with two particles for  $n = 3$  are represented in Figures 19–20 in Appendix B.

Another variant of TASEP found in the literature is the TASEP with periodic boundary conditions, in which the particles travel around a circle (see Figure 10, the circle is rigid, not subject to rotation). Since there are no border walls in these configurations, the Markov chain  $\widehat{S}$  is defined using only Case *a* of the transition rule  $\theta$  of the TASEP with boundaries. In the periodic TASEP the numbers of black,  $\times$  and white particles do not change, and the case without  $\times$  particle immediately leads to a uniform stationary distribution. Our approach is easily adapted to deal with the more interesting case where there are  $\times$  particles. Indeed one can associate to this model a new set  $\widehat{\Omega}_n$  of complete configurations, made of two rows of cells arranged on a circle. As for  $\Omega_n$ , configurations of  $\widehat{\Omega}_n$  are subject to the condition that the blocks between two  $|\times|$ -columns, when read in clockwise direction, satisfy the positivity constraints. Since the number of black, white and  $\times$  particles never change in this system, we concentrate on the set  $\widehat{\Omega}_{k,m}^\ell$  of configurations of  $\widehat{\Omega}_n$  with  $\ell$   $|\times|$ -columns,  $k$  black and  $m$  white particles in the top row. In Section 2 we prove that cardinality of  $\widehat{\Omega}_{k,m}^\ell$  is  $\binom{n}{k} \binom{n}{m}$ . Again Case *a* of the evolution rule  $T$  is sufficient to define an evolution rule  $\widehat{T}$  on  $\widehat{\Omega}_{k,m}^\ell$  and an associated bijection from  $\widehat{\Omega}_{k,m}^\ell \times \{0, \dots, n-1\}$  to itself. The same arguments as for the chain  $X$  show that the resulting Markov chain  $\widehat{X}$  has uniform stationary distribution, and this yields:

$$\text{Prob}(\widehat{X}(t) = \omega) \xrightarrow[t \rightarrow \infty]{} \frac{1}{|\widehat{\Omega}_{k,m}^\ell|} = \frac{1}{\binom{n}{k} \binom{n}{m}}.$$

The stationary distribution of the TASEP  $\widehat{S}$  is then combinatorially expressed in terms of complete configurations:

$$\text{Prob}(\widehat{S}(t) = r) \xrightarrow[t \rightarrow \infty]{} \frac{|\{\omega \in \widehat{\Omega}_{k,m}^\ell \mid \text{top}(\omega) = r\}|}{|\widehat{\Omega}_{k,m}^\ell|}.$$

**1.5. Outline of the rest of the paper.** In Section 2 the different classes of complete configurations are enumerated. The main bijections are studied in Section 3, and in Section 4 the chains are proven to be irreducible. Finally some concluding remarks are gathered in Section 5.

## 2. Complete configurations and the cycle lemma

In this section we state the enumerative lemmas (see proofs in Appendix A). Given a complete configuration of length  $n$ , and an integer  $j$ ,  $0 \leq j \leq n$ , let  $B(j)$  and  $W(j)$  be respectively the numbers of black and white particles lying in the first  $j$ -th columns (from left to right), and set  $E(j) = B(j) - W(j)$ . In other terms, the quantities  $B(j)$ ,  $W(j)$  and  $E(j)$  represent the number of black particles, the number of white particles, and their difference on the left-hand side of the  $j$ th wall. In particular,  $E(0) = E(n) = 0$ , and Condition (iii) of the definition of complete configurations reads  $E(j) \geq 0$  for  $j = 0, \dots, n$  (this is why we call it a positivity condition). Readers with a background in enumerative combinatorics may recognize bicolored Motzkin paths in disguise [Sta99, Ch. 6].

**Lemma 2.1.** *The number  $|\Omega_n|$  of complete configurations of  $\Omega_n$  is  $\frac{1}{2} \binom{2n+2}{n+1}$ .*

**Lemma 2.2.** *Let  $k, \ell, m, n$  be non negative integers with  $k + \ell + m = n$ . The number  $|\Omega_{k,m}^\ell|$  of complete configurations of  $\Omega_n$  with  $\ell$   $|\times|$ -columns,  $k$  black and  $m$  white particles on the top row, and  $m$  black and  $k$  white particles on the bottom row is  $\frac{\ell+1}{n+1} \binom{n+1}{k} \binom{n+1}{m}$ .*

**Lemma 2.3.** *The number  $|\Omega_p^\ell|$  of complete configurations of  $\Omega_n$ , for  $p + \ell = n$ , with  $\ell$   $|\times|$ -columns, and  $p$  black and  $p$  white particles distributed between the two rows is  $\frac{\ell+1}{n+1} \binom{2n+2}{p}$ .*

**Remark.** As already said, when  $\ell = 0$  we have configurations with just two kinds of particles. In this case, from Lemma 2.2 and Lemma 2.3, we have  $|\Omega_{k,m}^0| = \frac{1}{n+1} \binom{n+1}{k} \binom{n+1}{m}$  and  $|\Omega_n^0| = \frac{1}{n+1} \binom{2n+2}{n}$ .

**Lemma 2.4.** *The number  $|\widehat{\Omega}_{k,m}|$  of configurations of  $|\widehat{\Omega}_n|$  having  $\ell$   $|\times|$ -columns,  $k$  black particles at the top, and  $m$  at the bottom is  $\binom{n}{k} \binom{n}{m}$ .*

## 3. The bijections $\bar{T}$ and $\bar{T}'$

In this section we describe the mappings  $\bar{T}$  and  $\bar{T}'$  case by case and check that they are bijections from  $\Omega_n \times \{0, \dots, n\}$  to itself.

We shall partition the set  $\Omega_n \times \{0, \dots, n\}$  into classes  $A_{a'_1}, A_{a'_2}, A_{a_2}, A_{a_3}, A_{b_1}, A_{b_2}, A_{c_1}, A_{c_2}, A_d$ , and describe, for each class  $A_\alpha$ , its images  $B_\alpha = \bar{T}(A_\alpha)$  and  $B'_\alpha = \bar{T}'(A_\alpha)$  under the action of  $\bar{T}$  and  $\bar{T}'$ . From now on,  $(\omega, i)$  denotes an element of the current class, and  $(\omega', j)$  its image, either by  $\bar{T}$  or by  $\bar{T}'$  depending on the context. In the pairs  $(\omega, i)$  and  $(\omega', j)$ ,  $i$  and  $j$  refer to walls of the configurations  $\omega$  and  $\omega'$ , and  $i$  is called the active wall of  $\omega$ . Following the notations of Section 1, when  $i \neq 0$ , we also consider  $j_1 < i$  the smallest integer such that in the top row of  $\omega$  all cells between walls  $j_1$  and  $i - 1$  contain white particles. Symmetrically, when  $i \neq n$ , we consider  $j_2 > i$  the largest integer such that in the top row of  $\omega$  all cells between walls  $i + 1$  and  $j_2$  contain black particles. In the first few cases the applications  $\bar{T}$  and  $\bar{T}'$  do not differ, so a common description is given. Later on, they are distinguished.

$A_{a_1}$  The active wall of  $\omega$  separates in the top row a black particle  $P$  and a white particle  $Q$ . Then in the top row the particles  $P$  and  $Q$  swap. In the bottom row, the sweep that occurs depends on the type of the particle  $R$  that is below  $Q$  in  $\omega$  (see Figure 11):

$A_{a'_1}$  The particle  $R$  is black. Then  $j = j_1$  and, in the bottom row, a white sweep occurs between walls  $j$  and  $i$ . Observe that  $\omega'$  belongs to  $\Omega_n$ . Indeed  $\omega'$  can also be described as obtained from  $\omega$  by moving a  $|\bullet|$ -column from the right of the  $i$ th wall to the right of the  $j$ th. But moving a  $|\bullet|$ -column has no effect on the positivity constraints.

The image  $B_{a'_1} = B'_{a'_1}$  of the class  $A_{a'_1}$  consists of pairs  $(\omega', j)$  such that: there is not a white particle on the left-hand side of the  $j$ th wall in the top row of  $\omega'$ , there is a  $|\bullet|$ -column on its

right-hand side, and the sequence of white particles on the right-hand side of the  $j$ th wall in the top row is followed by a black particle.

$A_{a'_1}$  The particle  $R$  is white. Then  $j = j_2$  and, in the bottom row, a black sweep occurs between walls  $i + 1$  and  $j + 1$  (resp.  $i + 1$  and  $j$ ) if on the right of  $j$  there is a white particle (resp. an  $|\times|$ -column or the border). The new configuration  $\omega'$  satisfies clearly the positivity condition at all walls but  $i$ . But there is a  $|\circ|$ -column on the right of  $i$  in  $\omega$ , so that in this configuration  $B(i) - W(i) \geq 2$ , and this quantity remains non negative in  $\omega'$ .

The image  $B_{a'_1} = B'_{a'_1}$  of the class  $A_{a'_1}$  consists of pairs  $(\omega', j)$  with a  $|\circ|$ -column, an  $|\times|$ -column, or the border on the right-hand side of the  $j$ th wall of  $\omega'$  and such that there is a non-empty sequence of black particles on the left-hand side of the  $j$ th wall in the top row, followed by a white particle.

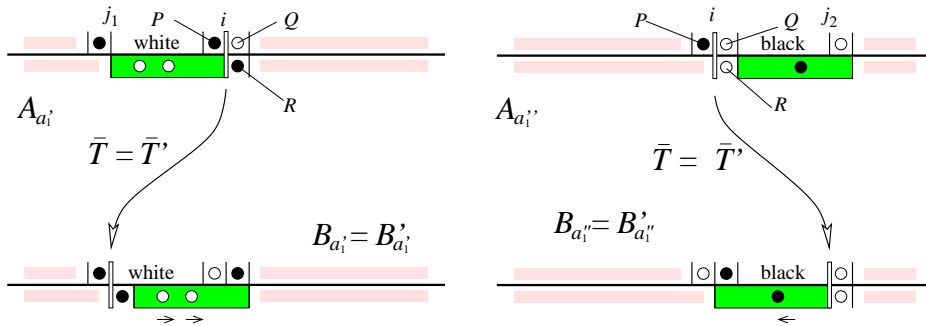

FIGURE 11. Jump moves in the  $(\bullet|\circ \rightarrow \circ|\bullet)$  case.

$A_{a_2}$  The active wall of  $\omega$  separates in the top row an  $\times$  particle  $P$  and a white particle  $Q$ . We remark that, in order to satisfy the positivity constraint, the cell under  $Q$  must contain a black particle  $R$  (see Figure 12, left-hand side). Then in the top row the particles  $P$  and  $Q$  swap. In the bottom row, the  $\times$  particle under  $P$  and the particle  $R$  swap, and then a white sweep occurs between walls  $j = j_1$  and  $i - 1$ . Observe that  $\omega'$  belongs to  $\Omega_n$ . Indeed  $\omega'$  can also be described as obtained from  $\omega$  by moving a  $|\circ|$ -column from the right of the  $i$ th wall to the right of the  $j$ th.

The image  $B_{a_2} = B'_{a_2}$  of the class  $A_{a_2}$  consists of pairs  $(\omega', j)$  such that: there is not a white particle on the left-hand side of the  $j$ th wall in the top row of  $\omega'$ , there is a  $|\circ|$ -column on its

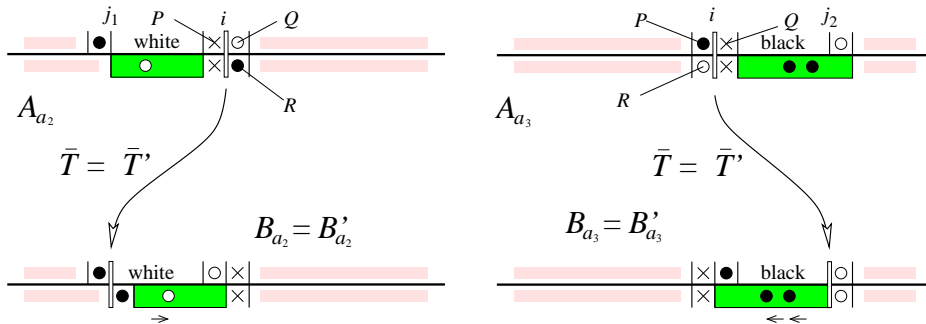

FIGURE 12. Jump moves in the  $(\times|\circ \rightarrow \circ|\times)$  and  $(\bullet|\times \rightarrow \times|\bullet)$  cases.

right-hand side and the sequence of white particles on the right-hand side of the  $j$ th wall in the top row is followed by an  $\times$  particle.

$A_{a_3}$  The active wall of  $\omega$  separates in the top row an black particle  $P$  and an  $\times$  particle  $Q$ . This time the cell under  $P$  must contain a white particle  $R$  (see Figure 12, right-hand side). Then the particles  $P$  and  $Q$  swap. In the bottom row, the particle  $R$  and the  $\times$  particle under  $Q$  swap, and then a black sweep occurs between walls  $i+1$  and  $j+1$  with  $j = j_2$  (or between walls  $i+1$  and  $j$  if an  $|\times|$ -column or the border is reached). The configuration  $\omega'$  belongs to  $\Omega_n$  since a  $|\times|$  and a  $|\bullet|$ -column swap and no other black particle moves to the right.

The image  $B_{a_3} = B'_{a_3}$  of the class  $A_{a_3}$  consists of pairs  $(\omega', j)$  with a  $|\circ|$ -column, an  $|\times|$ -column, or the border on the right of the  $j$ th wall of  $\omega'$  and such that there is a non-empty sequence of black particles on the left-hand side of the  $j$ th wall in the top row, followed by an  $\times$  particle.

$A_{b_1}$  The active wall of  $\omega$  is the left border with a white particle  $Q$  on its right in the top row. Again, the cell under  $Q$  must contain a black particle  $R$  (see Figure 13). Then the images by  $\bar{T}$  and  $\bar{T}'$  are different:

- $\bar{T}$  is applied. First the particles  $Q$  and  $R$  are replaced by  $|\bullet|$ -column. Then  $j = j_2$  and, in the bottom row, a black sweep occurs between walls 1 and  $j+1$  (or between walls 1 and  $j$  if an  $|\times|$ -columns or the border is reached). The configuration  $\omega'$  belongs to  $\Omega_n$ . Indeed no black particle moves to the right.

The image  $B_{b_1}$  of the class  $A_{b_1}$  consists of pairs  $(\omega', j)$  with a  $|\circ|$ -column, an  $|\times|$ -column, or the border on the right of the  $j$ th wall of  $\omega'$  and such that there is a non-empty sequence of black particles on the left of the  $j$ th wall in the top row, ending at the left border.

- $\bar{T}'$  is applied. Then both  $Q$  and  $R$  particles are replaced by  $\times$  particles, and  $j = 0$ . The configuration  $\omega'$  belongs to  $\Omega_n$  since a  $|\bullet|$ -column was replaced by an  $|\times|$ -column.

The image  $B'_{b_1}$  of  $A_{b_1}$  consists of pairs  $(\omega', 0)$  with an  $|\times|$ -column on the left border.

$A_{b_2}$  The active wall of  $\omega$  is the left border with an  $\times$  particle  $Q$  on its right in the top row. The particle  $R$  under  $Q$  must be an  $\times$  particle (see Figure 14):

- $\bar{T}$  is applied. Then  $\omega' = \omega$  and  $j = 0$ . The image  $B_{b_2}$  of the class  $A_{b_2}$  consists of pairs  $(\omega', 0)$  with a  $|\times|$ -column on the left border.

- $\bar{T}'$  is applied. First, the particles  $Q$  and  $R$  are replaced by a  $|\bullet|$ -column. Then a black sweep occurs between walls 1 and  $j+1$  with  $j = j_2$  (or between 1 and  $j$  if a  $|\times|$ -columns or the border is reached). The configuration  $\omega'$  belongs to  $\Omega_n$  since no black particle moves to the right.

The image  $B'_{b_2}$  of the class  $A_{b_2}$  consists of pairs  $(\omega', j)$  with a  $|\circ|$ -column, an  $|\times|$ -column, or the border on the right of the  $j$ th wall of  $\omega'$  and such that there is a non-empty sequence of black particles on the left of the  $j$ th wall in the top row, ending at the left border.

$A_{c_1}$  The active wall of  $\omega$  is the right border with a black particle  $Q$  on its left in the top row. The cell under  $Q$  must contain a white particle  $R$  (see Figure 15):

- $\bar{T}$  is applied. First the particles  $Q$  and  $R$  are replaced by a  $|\bullet|$ -column. Then  $j = j_1$  and, in the bottom row, a white sweep occurs between walls  $j$  and  $n-1$ . The configuration  $\omega'$  belongs to  $\Omega_n$  since the transformation amounts to moving and flipping a  $|\bullet|$ -column.

The image  $B_{c_1}$  of the class  $A_{c_1}$  consists of pairs  $(\omega', j)$  such that: there is not a white particle on the left-hand side of the  $j$ th wall of  $\omega'$  in the top row, there is a  $|\bullet|$ -column on its right-hand side, and such that the sequence of white particles on the right-hand side of the  $j$ th wall in the top row ends at the right border.

- $\bar{T}'$  is applied. Then both  $Q$  and  $R$  are replaced by  $\times$  particles, and  $j = n$ . The configuration  $\omega'$  belongs to  $\Omega_n$  since a  $|\bullet|$ -column is replaced by a  $|\times|$ -column.

The image  $B'_{c_1}$  of  $A_{c_1}$  consists of pairs  $(\omega', n)$  with an  $|\times|$ -column on the right border.



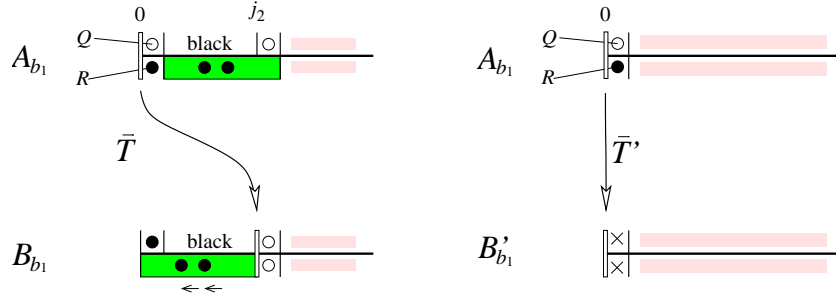

FIGURE 13. Active left border with a white particle in the top row.

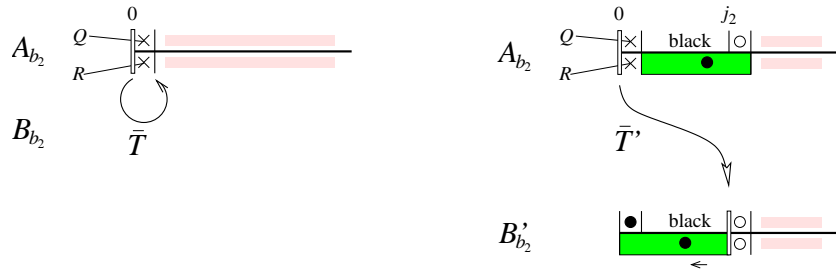

FIGURE 14. Active left border with an  $x$  particle in the top row.

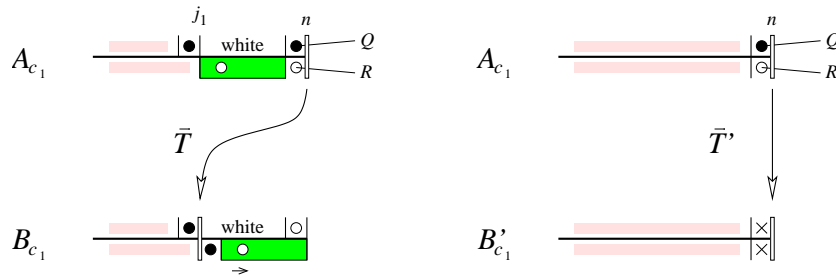

FIGURE 15. Active right border with a black particle in the top row.

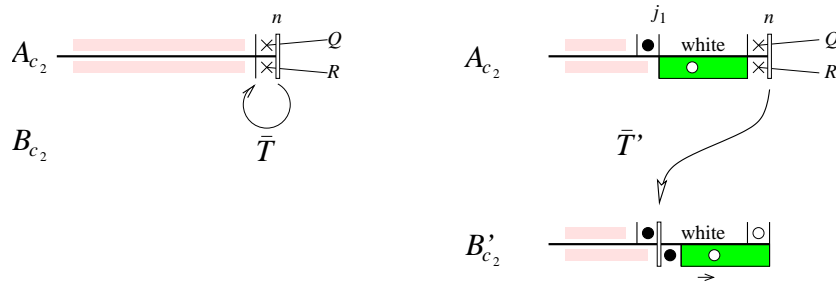

FIGURE 16. Active right border with a  $\times$  particle in the top row.

$A_{c_2}$  The active wall of  $\omega$  is the right border with an  $\times$  particle  $Q$  on its left in the top row. The particle  $R$  under  $Q$  must be an  $\times$  particle (see Figure 16). Then the image by  $\bar{T}$  and  $\bar{T}'$  are:

- $\bar{T}$  is applied. Then  $\omega' = \omega$  and  $j = n$ . The image  $B_{c_2}$  of the class  $A_{c_2}$  consists of pairs  $(\omega', n)$  with a  $|\times|$ -column on the right border.
- $\bar{T}'$  is applied. First, the particles  $Q$  and  $R$  are replaced by a  $|\bullet^\circ|$ -column. Then a white sweep occurs between walls  $j = j_1$  and  $n - 1$ . The configuration  $\omega'$  belongs to  $\Omega_n$ . Indeed the operation amounts to the introduction of a  $|\bullet^\circ|$ -column at the  $j$ th wall. The image  $B'_{c_2}$  of the class  $A_{c_2}$  consists of pairs  $(\omega', j)$  such that: there is not a white particle on the left-hand side of the  $j$ th wall of  $\omega'$  in the top row, there is a  $|\bullet^\circ|$ -column on its right-hand side, and the sequence of white particles on the right-hand side of the  $j$ th wall in the top row ends at the right border.

$A_d$  This class contains all the remaining cases. For these configurations the mappings  $\bar{T}$  and  $\bar{T}'$  do not change anything, that is, for  $(\omega, i) \in A_d$ ,  $\bar{T}(\omega, i) = \bar{T}'(\omega, i) = (\omega, i)$ .

**Theorem 3.1.** *The mappings  $\bar{T}, \bar{T}' : \Omega_n \times \{0, \dots, n\} \rightarrow \Omega_n \times \{0, \dots, n\}$  are bijections.*

PROOF. In each case the transformations are clearly reversible. We conclude by checking that both  $\{B_{a'_1}, B_{a''_1}, B_{a_2}, B_{a_3}, B_{b_1}, B_{b_2}, B_{c_1}, B_{c_2}, B_d\}$  and  $\{B_{a'_1}, B_{a''_1}, B_{a_2}, B_{a_3}, B'_{b_1}, B'_{b_2}, B'_{c_1}, B'_{c_2}, B_d\}$  are partitions of  $\Omega_n \times \{0, \dots, n\}$ .  $\square$

For the two particle model, it suffices to observe that the restriction of  $\bar{T}$  to  $\Omega_n^0 \times \{0, \dots, n\}$  is a bijection onto  $\Omega_n^0 \times \{0, \dots, n\}$ . For the three particle model on the circle, a bijection from  $\hat{\Omega}_{k,m}^\ell$  onto itself is readily obtained using the constructions in cases  $A_{a'_1}, A_{a''_1}, A_{a_2}$  and  $A_{a_3}$ .

#### 4. Paths between two configurations

In this section we verify that the Markov chains  $X^0$ ,  $\hat{X}$  and  $X$  are irreducible, *i.e.* that there is a positive probability to go from any configuration  $\omega$  to any other one  $\omega'$ . In other terms we need to prove that the transition graph defined on  $\Omega_n$  by  $T$  and  $T'$  is connected. The proof is based on an observation about iterating the bijections  $\bar{T}$  or  $\bar{T}'$ , and on induction on  $n$ .

To every pair  $(\omega, i)$  of  $\Omega_n \times \{0, \dots, n\}$  we associate a reduced configuration  $\omega^i$  in  $\Omega_{n-1}$ , obtained from  $\omega$  by deleting two particles around the wall  $i$  using the following rules:

- if  $(\omega, i)$  belongs to  $A_{a'_1}, A_{a_2}$  or  $A_{b_1}$  then  $\omega^i$  is obtained by removing the  $|\bullet^\circ|$ -column on the right-hand side of the wall  $i$  (particles  $Q$  and  $R$  on the corresponding figure),
- if  $(\omega, i)$  belongs to  $A_{a''_1}$  then  $\omega^i$  is obtained by removing the two particles forming the configurations  $\bullet|_\circ$  around the wall  $i$  (particles  $P$  and  $R$  on the corresponding figure),
- if  $(\omega, i)$  belongs to  $A_{a_3}$  or  $A_{c_1}$  then  $\omega^i$  is obtained by removing the  $|\bullet^\circ|$ -column on the left-hand side of the wall  $i$  (particles  $P$  and  $R$  on the corresponding figure),
- if  $(\omega, i)$  belongs to  $A_{b_2}$ , then  $\omega^i$  is obtained by removing the  $|\times|$ -column on the left border,
- if  $(\omega, i)$  belongs to  $A_{c_2}$ , then  $\omega^i$  is obtained by removing the  $|\times|$ -column on the right border.

**Lemma 4.1.** *Let  $\omega'$  be a configuration of  $\Omega_{n-1}$ . Let  $S(\omega')$  be the set of pairs  $(\omega, i)$  of  $\Omega_n \times \{0, \dots, n\}$  having  $\omega'$  as reduced configuration, *i.e.* such that  $\omega^i = \omega'$ . Then:*

- the set  $S(\omega')$  is a cyclic orbit of  $\bar{T}'$ : given  $(\omega, i) \in S$  all other elements of  $S$  can be reached by successive applications of  $\bar{T}'$ ,
- the set  $S(\omega') \setminus \{(\omega'_0, 0), (\omega'_n, n)\}$  is a cyclic orbit of  $\bar{T}$ , where  $\omega'_0$  is the configuration  $|\times|\omega'$  and  $\omega'_n$  is the configuration  $\omega'|\times|$ .

PROOF. As can be checked on the left-hand sides of Figures 11 and 12, iterating  $\bar{T}$ , or  $\bar{T}'$  from a pair  $(\omega, i)$  of  $A_{a'_1}$  or  $A_{a_2}$ , the selected wall moves to the left with the pair of particles  $P$  and  $R$ , and successively

stops on the right hand side of every black or  $\times$  particle of the top row, until it reaches the left border. Similarly, as can be checked on the right-hand sides of Figures 11 and 12, iterating  $\bar{T}$  or  $\bar{T}'$  from a pair of  $A_{a''}$  or  $A_{a_2}$ , the selected wall moves to the right with the pair of particles  $P$  and  $R$ , stopping on the left hand side of every white and  $\times$  particles of the top row, until it reaches the right border.

As shown by Figures 13–16, the application  $\bar{T}$  and  $\bar{T}'$  behave differently when the border is reached:  $\bar{T}'$  visits the configurations  $\omega'_0$  or  $\omega'_n$  while  $\bar{T}$  skips them and restart moving in the opposite direction.

Starting from an element  $(\omega, i)$  all other elements of  $S(\omega')$  (respectively  $S \setminus \{\omega'_0, \omega'_n\}$ ) are thus visited in a cycle by successive applications of  $\bar{T}'$  (respectively  $\bar{T}$ ).  $\square$

Lemma 4.1 provides us with cycles in the transition graph on  $\Omega_n$ , and each cycle is associated to a reduced configuration of  $\Omega_{n-1}$ . The next lemma transports transitions from  $\Omega_{n-1}$  to  $\Omega_n$ .

**Lemma 4.2.** *Let  $(\omega', j) = \bar{T}'(\omega, i)$  be a transition between two configurations of  $\Omega_{n-1}$ . Then there exists pairs  $(\omega_+, i_+) \in S(\omega)$  and  $(\omega'_+, j_+) \in S(\omega')$  such that  $(\omega'_+, j_+) = \bar{T}'(\omega_+, i_+)$ .*

PROOF. In each case of Figures 11–16, an  $|\times|$ -column can be inserted, either on the left or on the right border, without interfering with the action of  $\bar{T}'$ .  $\square$

Lemma 4.2 gives a transition between an element of the cycle associated to  $\omega$  and an element of the cycle associated to  $\omega'$ . Taking the connectivity of the transition graph on  $\Omega_{n-1}$  as induction hypothesis, we conclude that all cycles of Lemma 4.1 belong to the same connected component of the transition graph on  $\Omega_n$ . Since every element of  $\Omega_n$  belong to a cycle, this concludes the proof of the irreducibility of  $X$ . The proofs for  $X^0$  and  $\hat{X}$  are similar.

## 5. Conclusions and relations to Brownian excursions

The starting point of this paper was a “combinatorial Ansatz”: the stationary distribution of the two and three particle TASEP with or without boundaries can be expressed in terms of Catalan numbers hence should have a nice combinatorial interpretation. In our interpretation, configurations of the TASEP are completed by a (usually hidden) second row in which particles go back. The resulting system has a uniform stationary distribution so that the probability of a given TASEP configuration just reflects the diversity of possible rows hidden below it.

We do not claim that our combinatorial interpretation is of any physical relevance. However, apart from explaining the “magical” occurrence of Catalan numbers in the problem, it sheds new light on the recent results of Derrida *et al.* [DEL] connecting the TASEP with Brownian excursion. More precisely, using explicit calculations, Derrida *et al.* show that the density of black particles in configurations of the two particle TASEP can be expressed in terms of a pair  $(e_t, b_t)$  of independent processes, a Brownian excursion  $e_t$  and a Brownian motion  $b_t$ . In our interpretation these two quantities appear at the discrete level, associated to each complete configuration  $\omega$  of  $\Omega_n^0$ :

- The role of the Brownian excursion for  $\omega$  is played by the halved differences  $e(i) = \frac{1}{2}(B(i) - W(i))$  between the number of black and white particles sitting on the left of the  $i$ th wall, for  $i = 0, \dots, n$ . By definition of complete configurations,  $(e(i))_{i=0, \dots, n}$  is a discrete excursion, that is,  $e(0) = e(n) = 0$ ,  $e(i) \geq 0$  and  $|e(i) - e(i-1)| \in \{0, 1\}$ , for  $i = 0, \dots, n$ .
- The role of the Brownian motion is played for  $\omega$  by the differences  $b(i) = B_{top}(i) - B_{bot}(i)$  between the number of black particles sitting in the top and in the bottom row, on the left of the  $i$ th wall, for  $i = 0, \dots, n$ . This quantity  $(b(i))_{i=0, \dots, n}$  is a discrete walk, with  $|b(i) - b(i-1)| \in \{0, 1\}$  for  $i = 0, \dots, n$ .

Since  $e(i) + b(i) = 2B_{top}(i) - i$ , these quantities allow one to describe the cumulated number of black particles in the top row of a complete configuration. Accordingly, the density in a given segment  $(i, j)$  is

$(B_{top}(j) - B_{top}(i))/(j - i) = \frac{1}{2} + \frac{e(j) - e(i)}{2(j-i)} + \frac{b(j) - b(i)}{2(j-i)}$ . This is a discrete version of the quantity considered by Derrida *et al.* in [DEL].

Now the two walks  $e(i)$  and  $b(i)$  are correlated since one is stationary when the other is not, and vice-versa:  $|e(i) - e(i-1)| + |b(i) - b(i-1)| = 1$ . Given  $\omega$ , let  $I_e = \{\alpha_1 < \dots < \alpha_p\}$  be the set of indices of  $|\bullet|$ - and  $|\circ|$ -columns, and  $I_b = \{\beta_1 < \dots < \beta_q\}$  the set of indices of  $|\circ|$ - and  $|\bullet|$ -columns ( $p + q = n$ ). Then the walk  $e'(i) = e(\alpha_i) - e(\alpha_{i-1})$  is the excursion obtained from  $e$  by ignoring stationary steps, and the walk  $b'(i) = b(\beta_i) - b(\beta_{i-1})$  is obtained from  $b$  in the same way. Conversely given a simple excursion  $e'$  of length  $p$ , a simple walk  $b'$  of length  $q$  and a subset  $I_e$  of  $\{1, \dots, p + q\}$  of cardinality  $p$ , two correlated walks  $e$  and  $b$ , and thus a complete configuration  $\omega$  can be uniquely reconstructed. The consequence of this discussion is that the uniform distribution on  $\Omega_n^0$  corresponds to the uniform distribution of triples  $(I_e, e', b')$  where, given  $I_e$ , the processes  $e'$  and  $b'$  are independent.

A direct computation shows that in the large  $n$  limit, with probability exponentially close to 1, a random configuration  $\omega$  is described by a pair  $(e', b')$  of walks of roughly equal lengths  $n/2 + O(n^{1/2+\varepsilon})$ . In particular, up to multiplicative constants, the normalized pairs  $(\frac{e'(tn/2)}{n^{1/2}}, \frac{b'(tn/2)}{n^{1/2}})$  and  $(\frac{e(tn)}{n^{1/2}}, \frac{b(tn)}{n^{1/2}})$  both converge to the same pair  $(e_t, b_t)$  of independent processes, with  $e_t$  a standard Brownian excursion and  $b_t$  a standard Brownian walk.

We thus obtain a combinatorial interpretation of the appearance of the pair  $(e_t, b_t)$  in the two particle TASEP. The result now extends immediately to the three particle TASEP: it follows from the construction of Lemma 2.1 that the uniform distribution on  $\Omega_n$  leads to a pair  $(e', b')$  where the continuum limit of  $e'$  is now a reflected Brownian bridge, while  $b'$  remains a Brownian bridge. More generally conditioning on the number of  $x$  particles amounts to conditioning on the local time at the origin of the process  $e$ .

Another possible outcome of our approach could be an explicit construction of a continuum TASEP by taking the limit of the Markov chain  $X^0$ , viewed as a Markov chain on pairs of walks. An appealing way to give a geometric meaning to the transitions in the continuum limit could be to use a representation in terms of parallelogram polyominoes, using the process  $e(t)$  (or  $e_t$  in the continuum limit) to describe the width of the polyomino and the process  $b(t)$  (or  $b_t$  in the continuum limit) to describe the vertical displacement of its spine.

**Acknowledgments.** Referees are warmly thanked for their great help in improving the paper.

## References

- [And88] Liggett Andjel, Bramson, *Shocks in the asymmetric exclusion process*, Prob. Th. Related Fields **78** (1988), 231–247.
- [DDM92] B. Derrida, E. Domany, and D. Mukamel, *An exact solution of a one dimensional asymmetric exclusion model with open boundaries*, J. Stat. Phys. **69** (1992), 667–687.
- [DEHP93] B. Derrida, M.R. Evans, V. Hakim, and V. Pasquier, *Exact solution of a one-dimensional asymmetric exclusion model using a matrix formulation*, J. Phys. A: Math. **26** (1993), 1493–.
- [DEL] B. Derrida, C. Enaud, and J. L. Lebowitz, *The asymmetric exclusion process and brownian excursions*, Available electronically as [arXiv:cond-mat/0306078](https://arxiv.org/abs/cond-mat/0306078).
- [DLS03] B. Derrida, J. L. Lebowitz, and E. R. Speer, *Exact large deviation functional of a stationary open driven diffusive system: the asymmetric exclusion process*, J. Stat. Phys. **110** (2003), 775–810.
- [DS04] E. Duchi and G. Schaeffer, *A combinatorial approach to jumping particles II: general boundary conditions*, Submitted, 2004.
- [Hö2] O. Häggström, *Finite markov chains and algorithmic applications*, Cambridge University Press, 2002.
- [Lig85] T. M. Liggett, *Interacting particle systems*, Springer, New York, 1985.
- [Lot99] M. Lothaire, *Combinatorics on words*, 2nd ed., Cambridge University Press, 1999.
- [Spo91] H. Spohn, *Large scale dynamics of interacting particles*, Texts and Monographs in Physics, Springer, 1991.
- [Sta99] R. Stanley, *Enumerative combinatorics, volume ii*, Cambridge University Press, 1999.

CAMS, EHESS, 52 BD RASPAIL, 75006 PARIS, FRANCE

*E-mail address:* `Enrica.Duchi@ehess.fr`

LIX, CNRS, ÉCOLE POLYTECHNIQUE,, 91128 PALAISEAU, FRANCE

*E-mail address:* `Gilles.Schaeffer@lix.polytechnique.fr`

**Appendix A. Proofs of the enumerative lemmas of Section 2**

LEMMA 2.1. *The number  $|\Omega_n|$  of complete configurations of  $\Omega_n$  is  $\frac{1}{2} \binom{2n+2}{n+1}$ .*

PROOF. Let  $\Gamma_{n+1}$  be the set of (unconstrained) configurations of  $n + 1$  black and  $n + 1$  white particles distributed between two rows of  $n + 1$  cells, so that  $|\Gamma_{n+1}| = \binom{2n+2}{n+1}$ . Among these configurations, we restrict our attention to those ending with a column with a black particle in the top cell and a white particle in the bottom cell (called a  $|\bullet_\circ|$ -column for simplicity), and those ending with a column with two black particles (a  $|\bullet_\bullet|$ -column). Let us denote the set of these configurations by  $\bar{\Gamma}_{n+1}$ . Exchanging black and white colors is obviously a bijection between  $\bar{\Gamma}_{n+1}$  and its complement in  $\Gamma_{n+1}$  so that  $|\bar{\Gamma}_{n+1}| = \frac{1}{2} \binom{2n+2}{n+1}$ .

The proof of the lemma now consists in the following bijection  $\phi$  between  $\Omega_n$  and  $\bar{\Gamma}_{n+1}$  (see Figure 17). Given  $\omega \in \Omega_n$ , its image  $\phi(\omega)$  is obtained as follows: First, if the number of  $|\times|$ -columns of  $\omega$  is even, add a  $|\bullet_\circ|$ -column at the end of  $\omega$ , otherwise add to it an  $|\times|$ -column. Then replace the first half of the  $|\times|$ -columns by  $|\circ|$ -columns, and the remaining half by  $|\bullet|$ -columns (from left to right). By construction the resulting  $\phi(\omega)$  belongs to  $\bar{\Gamma}_{n+1}$ . Consider now  $\gamma \in \bar{\Gamma}_{n+1}$ , and let  $d = \min(E(j))$  be the depth of  $\gamma$ . Then set  $j_i = \min\{j \mid E(j) = -2i\}$ , and  $j'_i = \max\{j \mid E(j-1) = -2i\}$ , for  $i = 1, \dots, |d|$ , and define the application  $\psi$  that first changes columns  $j_i$  and  $j'_i$  into  $|\times|$ -columns, and then removes the last column. By construction the blocks between two of the modified columns of  $\gamma$  satisfy the positivity condition, so that  $\phi(\gamma) \in \Omega_{n+1}$ , and the applications  $\phi$  and  $\psi$  are clearly inverses of each other.  $\square$

LEMMA 2.2. *Let  $k, \ell, m, n$  be non negative integers with  $k + \ell + m = n$ . The number  $|\Omega_{k,m}^\ell|$  of complete configurations of  $\Omega_n$  with  $\ell$   $|\times|$ -columns,  $k$  black and  $m$  white particles in the top row, and  $m$  black and  $k$  white particles in the bottom row is  $\frac{\ell+1}{n+1} \binom{n+1}{k} \binom{n+1}{m}$ .*

PROOF. The statement is verified using the cycle lemma (see [Lot99, Ch. 11], or [5, Ch. 5]). Let  $p = k + m$  and denote by  $\Delta_p^{\ell+1}$  the set of configurations with  $p$  black and  $p + 2\ell + 2$  white particles distributed between two rows of  $n + 1$  cells. Then the cardinality of the subset  $\Delta_{k,m}^{\ell+1}$  of elements of  $\Delta_p^{\ell+1}$  that have  $k$  black particles in the top row and the other  $m$  in the bottom row is  $\binom{n+1}{k} \binom{n+1}{m}$ . In such a configuration the number of white particles exceeds by  $2\ell + 2$  that of black particles, so that  $E(n + 1) = -2\ell - 2$ . Given  $\omega$  in  $\Delta_{k,m}^{\ell+1}$ , let  $d = \min(E(j))$  be the depth of  $\omega$ , and set  $j_i = \min\{j \mid E(j) = d + 2i\}$ , for  $i = 0, \dots, \ell$ . By construction, these  $\ell + 1$  columns are  $|\circ|$ -columns. On the one hand, let  $\bar{\Delta}_{k,m}^{\ell+1}$  be the set of pairs  $(\omega, j)$  where  $\omega \in \Delta_{k,m}^{\ell+1}$  and  $j \in \{j_0, \dots, j_\ell\}$ , so that  $|\bar{\Delta}_{k,m}^{\ell+1}| = \binom{n+1}{k} \binom{n+1}{m} \cdot (\ell + 1)$ . On the other hand, define the set  $\bar{\Omega}_{k,m}^{\ell+1}$  of pairs  $(\omega', i)$  where  $\omega'$  is obtained from an element of  $\Omega_{k,m}^\ell$  by adding a final  $|\times|$ -column, and  $i \in \{0, \dots, n\}$ . By construction,  $|\bar{\Omega}_{k,m}^{\ell+1}| = |\Omega_{k,m}^\ell| \cdot (n + 1)$ .

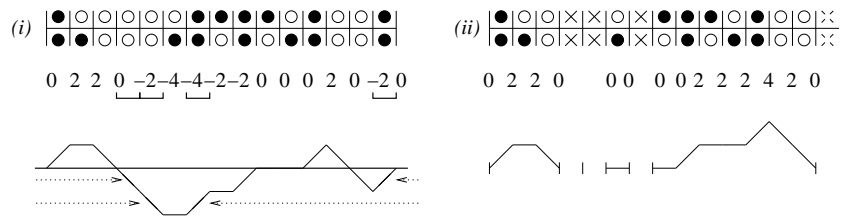

FIGURE 17. From (i) an element of  $\bar{\Gamma}_{n+1}$ , to (ii) one of  $\Omega_n$ . The  $(B(j) - W(j))_{j=0..n+1}$  are given under both configurations and graphically represented.

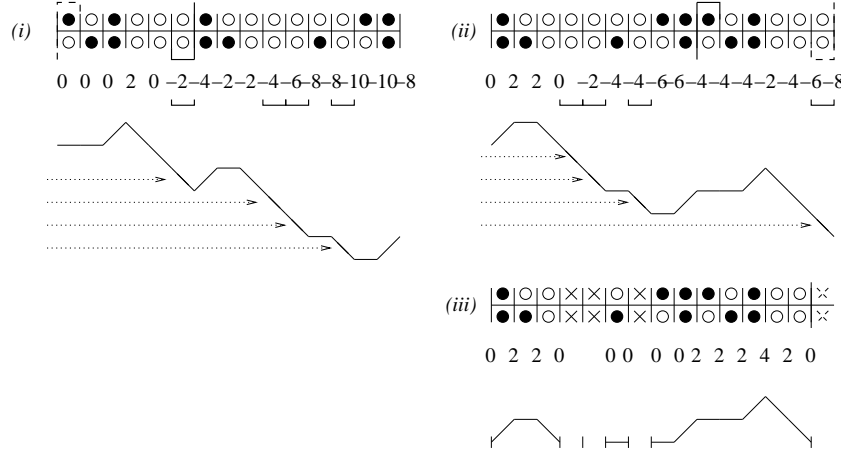

FIGURE 18. (i) An element of  $\bar{\Delta}_{k,m}^{\ell+1}$  (with  $\ell = 3$  and column  $j = 6$  colored), (ii) its conjugate (with column  $n + 1 - j$  colored), and (iii) the corresponding element of  $\Omega_{k,m}^{\ell}$ . The sequence  $(B(j) - W(j))_{j=0..n+1}$  is given under each configuration and graphically represented.

The proof of the lemma consists in a bijection  $\phi$  between  $\bar{\Delta}_{k,m}^{\ell+1}$  and  $\bar{\Omega}_{k,m}^{\ell+1}$  (see Figure 18). Given  $(\omega, j) \in \bar{\Delta}_{k,m}^{\ell+1}$ , let  $\omega_1$  denote the first  $j$  columns of  $\omega$ , and  $\omega_2$  the  $n + 1 - j$  others. Then by construction of  $j$ , the concatenation  $\omega_2|\omega_1$  satisfies  $E(i) > -2\ell - 2$  for  $i = 1, \dots, n$ , and  $E(n + 1) = -2\ell - 2$ . This implies that  $\omega_2|\omega_1$  decomposes as a sequence  $\omega'_0, \omega'_1, \dots, \omega'_\ell$  of  $\ell + 1$  (possibly empty) blocks that satisfy the positivity constraint, each followed by a  $|\circ|$ -column. Let  $\omega'$  be obtained by replacing these  $\ell + 1$   $|\circ|$ -columns by  $|\times|$ -columns. Then the map  $(\omega, j) \rightarrow (\omega', n + 1 - j)$  is a bijection of  $\bar{\Delta}_{k,m}^{\ell+1}$  onto  $\bar{\Omega}_{k,m}^{\ell+1}$ : the inverse bijection is readily obtained by first replacing the  $|\times|$ -columns into  $|\circ|$ -columns, and then recovering the factorization  $\omega_2|\omega_1$  from the fact that  $\omega_2$  has  $n + 1 - j$  columns.  $\square$

LEMMA 2.3. *The number  $|\Omega_p^\ell|$  of complete configurations of  $\Omega_n$ , for  $p + \ell = n$ , with  $\ell$   $|\times|$ -columns, and  $p$  black and  $p$  white particles distributed between the two rows is  $\frac{\ell+1}{n+1} \binom{2n+2}{p}$ .*

PROOF. The proof uses the same arguments than the proof of Lemma 2.2. The only difference is that, instead of counting elements of  $\Delta_{k,m}^{\ell+1}$  with  $k$  black particles in the top row and  $m$  in the bottom row, we count elements of  $\Delta_p^{\ell+1}$ , that have a total of  $p$  black particles. Hence the previous factor  $|\Delta_{k,m}^{\ell+1}| = \binom{n+1}{k} \binom{n+1}{m}$  is replaced by  $|\Delta_p^{\ell+1}| = \binom{2n+2}{p}$ .  $\square$

Remark. As already said, when  $\ell = 0$  we have configurations with just two kinds of particles. In this case, from Lemma 2.2 and Lemma 2.3, we have  $|\Omega_{k,m}^0| = \frac{1}{n+1} \binom{n+1}{k} \binom{n+1}{m}$  and  $|\Omega_n^0| = \frac{1}{n+1} \binom{2n+2}{n}$ .

Lemma 2.4. *The number  $|\widehat{\Omega}_{k,m}|$  of configurations of  $|\widehat{\Omega}_n|$  having  $\ell$   $|\times|$ -columns,  $k$  black particles at the top, and  $m$  at the bottom is  $\binom{n}{k} \binom{n}{m}$ .*

PROOF. Recall that  $\Delta_{k,m}^\ell$  denote configurations of length  $n$  with  $k$  black and  $m + \ell$  white particles in the top row, and  $m$  black and  $k + \ell$  white particles in the bottom row, so that  $|\Delta_{k,m}^\ell| = \binom{n}{k} \binom{n}{m}$ . In order to prove the statement of the lemma we show that  $\Delta_{k,m}^\ell$  and  $\widehat{\Omega}_{k,m}$  are in bijection. Let  $\delta \in \Delta_{k,m}^\ell$ , and consider its depth  $d = \min(E(i))$  and the  $\ell$  columns  $j_i = \min\{j \mid E(j) = d + 2i\}$ ,  $i = 0, \dots, \ell - 1$ ,

as in the proof of Lemma 2.3. By definition of these columns, the positivity condition is satisfied by each block between two of them. Moreover, by definition of  $j_0$  and  $j_{\ell-1}$ , the positivity condition is also satisfied by the concatenation  $\omega_\ell|\omega_0$  of the final block  $\omega_\ell$  and the initial block  $\omega_0$ . Hence transforming the columns  $j_0, \dots, j_\ell$  into  $|\times|$ -columns, and arranging the two rows in a circle by fusing walls 0 and  $n$  at the apex yields a configuration  $\phi(\delta)$  of  $\widehat{\Omega}_{k,m}$  (recall that these configurations are not considered up to rotation). Conversely, given  $\omega$  in  $\widehat{\Omega}_{k,m}$ , a unique element  $\delta$  of  $\Delta_{k,m}^\ell$  such that  $\phi(\delta) = \omega$  is obtained by opening at the apex and transforming  $|\times|$ -columns into  $|\circ|$ -columns.  $\square$

**Appendix B. A complete example**

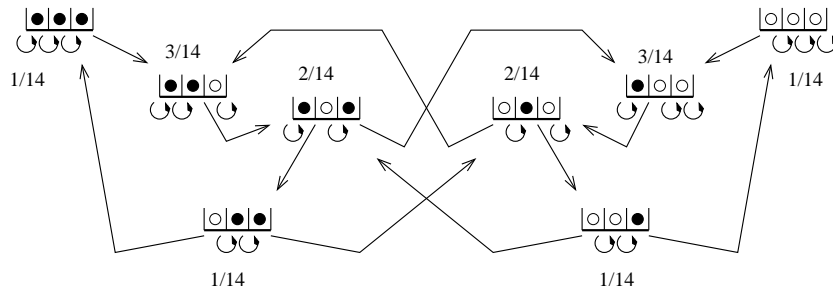

FIGURE 19. The basic configurations for  $n = 3$  and transitions between them. The starting point of each arrow indicates the wall triggering the transition. The numbers are the stationary probabilities.

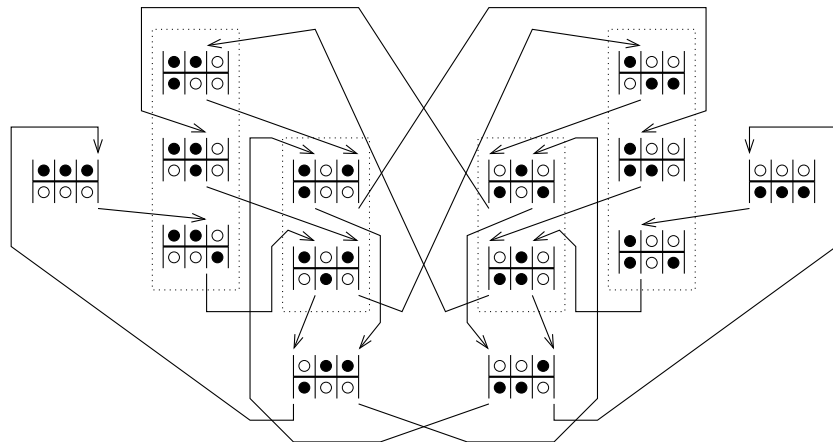

FIGURE 20. The 14 complete configurations for  $n = 3$  and transitions between them. The starting point of each arrow indicates the wall triggering the transition (loop transitions are not indicated). Stationary probabilities are uniform (equal to  $1/14$ ) since each configuration has equal in and out degrees. Ignoring the bottom rows reduces this Markov chain to the chain of Figure 19.





# Generalised Schur P–Functions and Weyl’s Denominator Formula

A. M. Hamel and R. C. King

**Abstract.** *We derive a general identity that relates generalised P–functions to the product of a Schur function and*

$$\prod_{1 \leq i < j \leq n} (x_i + y_j).$$

*This result generalises a number of well-known results in Robbins and Rumsey, Chapman, Tokuyama, and Macdonald. We also interpret our result in terms of  $\mu$ –alternating sign matrices.*

**Résumé.** *Nous dérivons une identité générale reliant les P–fonctions généralisées et, le produit d’une fonction de Schur et  $\prod_{1 \leq i < j \leq n} (x_i + y_j)$ . Ce résultat est une généralisation des travaux de Robbins et Rumsey, Chapman, Tokuyama, et Macdonald. Nous en donnons aussi une variante avec des  $\mu$ –matrices à signes alternants.*

## 1. Introduction

The fundamental expression

$$(1.1) \quad \prod_{1 \leq i < j \leq n} (x_i + y_j)$$

appears in a number of contexts in symmetric function theory. Given  $\mathbf{y} = y_1, y_2, \dots, y_n$  and  $\mathbf{x} = x_1, x_2, \dots, x_n$ , when  $\mathbf{y} = -\mathbf{x}$ , equation (1.1) is the Weyl denominator formula (also called the Vandermonde determinant):

$$(1.2) \quad \det(x_i^{n-j}) = \prod_{1 \leq i < j \leq n} (x_i - x_j).$$

For  $\mathbf{y} = \lambda \mathbf{x}$ , expression (1.1) becomes the  $\lambda$ –determinant formula of Robbins and Rumsey [RR86]:

$$(1.3) \quad \prod_{1 \leq i < j \leq n} (x_i + \lambda x_j) = \sum_{A \in \mathcal{A}_n} \lambda^{SE(A)} (1 + \lambda)^{NS(A)} \prod_{i=1}^n x_i^{NE_i(A) + SE_i(A) + NS_i(A)},$$

where the exponents are various parameters associated with alternating sign matrices and defined in Section 3. Bressoud [B01] asked for a combinatorial proof of (1.3) which was provided by Chapman [C01] who generalised it to:

$$(1.4) \quad \prod_{1 \leq i < j \leq n} (x_i + y_j) = \sum_{A \in \mathcal{A}_n} \prod_{i=1}^n x_i^{NE_i(A)} y_i^{SE_i(A)} (x_i + y_i)^{NS_i(A)}.$$

---

1991 *Mathematics Subject Classification.* Primary 05E05, 05E10.

*Key words and phrases.* Schur P–functions, shifted tableaux, alternating sign matrices.

The first author was supported in part by an NSERC Discovery Grant.

For  $\mathbf{y} = t\mathbf{x}$ , there is also the  $t$  deformation of the Weyl denominator formula due to Tokuyama [T88]:

$$(1.5) \quad \prod_{1 \leq i < j \leq n} (x_i + tx_j) s_\lambda(\mathbf{x}) s_{1^n}(\mathbf{x}) = \sum_{ST \in ST^\mu} t^{hgt(ST)} (1+t)^{str(ST)-n} x^{wgt(ST)},$$

where the sum is over semistandard shifted tableaux  $ST$  and where  $hgt$ ,  $str$ , and  $wgt$  are parameters associated with semistandard shifted tableaux and defined in Section 2. Note also that  $s_\lambda(\mathbf{x})$  is the Schur function, and  $s_{1^n}(\mathbf{x}) = x_1 x_2 \dots x_n$  is the Schur function of shape  $1^n$ .

Here we present a general identity that unifies results (1.2)-(1.5) and we also demonstrate a connection to a generalisation of Schur P-functions. Our identity can also easily be re-interpreted in terms of Schur Q-functions—see Section 2.

**The Main Result:**

Let  $\mu = \lambda + \delta$  be a strict partition of length  $\ell(\mu) = n$ , with  $\lambda$  a partition of length  $\ell(\lambda) \leq n$  and  $\delta = (n, n-1, \dots, 1)$ . In addition, let  $\mathbf{x} = (x_1, x_2, \dots, x_n)$  and  $\mathbf{y} = (y_1, y_2, \dots, y_n)$ . Then

$$(1.6) \quad P_\mu(\mathbf{x}/\mathbf{y}) = s_{1^n}(\mathbf{x}) s_\lambda(\mathbf{x}) \prod_{1 \leq i < j \leq n} (x_i + y_j),$$

where  $P_\mu(\mathbf{x}/\mathbf{y})$  is the generalised P-function defined in Section 2. Our paper is arranged as follows. Section 2 introduces the necessary background. Section 3 gives a formal statement of the result and provides a proof and detailed example. Section 4 demonstrates the connection to alternating sign matrices. Section 5 explores future directions involving other root systems.

## 2. Background

Let  $\lambda = (\lambda_1, \lambda_2, \dots, \lambda_p)$  with  $\lambda_1 \geq \lambda_2 \geq \dots \geq \lambda_p > 0$  be a partition of weight  $|\lambda| = \lambda_1 + \lambda_2 + \dots + \lambda_p$  and length  $\ell(\lambda) = p$ , where each  $\lambda_i$  is a positive integer for all  $i = 1, 2, \dots, p$ . Then  $\lambda$  defines a Young diagram  $F^\lambda$  consisting of  $p$  rows of boxes of lengths  $\lambda_1, \lambda_2, \dots, \lambda_p$  left-adjusted to a vertical line.

A partition  $\mu = (\mu_1, \mu_2, \dots, \mu_q)$  of length  $\ell(\mu) = q$  is said to be a strict partition if all the parts of  $\mu$  are distinct, that is  $\mu_1 > \mu_2 > \dots > \mu_q > 0$ . A strict partition  $\mu$  defines a shifted Young diagram  $SF^\mu$  consisting of  $q$  rows of boxes of lengths  $\mu_1, \mu_2, \dots, \mu_q$  left-adjusted this time to a diagonal line.

For any partition  $\lambda$  of length  $\ell(\lambda) \leq n$  let  $\mathcal{T}^\lambda(n)$  be the set of all semistandard tableaux  $T$  obtained by numbering all the boxes of  $F^\lambda$  with entries taken from the set  $\{1, 2, \dots, n\}$ , subject to the usual total ordering  $1 < 2 < \dots < n$ . The numbering must be such that the entries are:

- T1 weakly increasing across each row from left to right;
- T2 strictly increasing down each column from top to bottom.

The weight of the tableau  $T$  is given by  $wgt(T) = (w_1, w_2, \dots, w_n)$ , where  $w_k$  is the number of times  $k$  appears in  $T$  for  $k = 1, 2, \dots, n$ .

By the same token, for any strict partition  $\mu$  of length  $\ell(\mu) \leq n$  let  $ST^\mu(n)$  be the set of all semistandard shifted tableaux  $ST$  obtained by numbering all the boxes of  $SF^\mu$  with entries taken from the set  $\{1, 2, \dots, n\}$ , subject to the total ordering  $1 < 2 < \dots < n$ . The numbering must be such that the entries are:

- ST1 weakly increasing across each row from left to right;
- ST2 weakly increasing down each column from top to bottom;
- ST3 strictly increasing down each diagonal from top-left to bottom-right.

The weight of the tableau  $ST$  is again given by

$$wgt(ST) = (w_1, w_2, \dots, w_n),$$

where  $w_k$  is the number of times  $k$  appears in  $ST$  for  $k = 1, 2, \dots, n$ . The rules ST1-ST3 serve to exclude any  $2 \times 2$  blocks of boxes all containing the same entry, and as a result each  $ST \in ST^\mu(n)$  consists of a sequence of ribbon strips of boxes containing identical entries. Any given ribbon strip may consist of a number of disjoint connected components. Let  $str(ST)$  denote the total number of disjoint connected components of all the

ribbon strips. Let  $hgt(ST)$  be the height of the tableaux, defined  $hgt(ST) = \sum_{k=1}^n (row_k(ST) - con_k(ST))$ , where  $row_k(ST)$  is the number of rows of  $S$  containing an entry  $k$ , and  $con_k(ST)$  is the number of connected components of the ribbon strip of  $ST$  consisting of all the entries  $k$ .

Refining this construct, for any strict partition  $\mu$  with  $\ell(\mu) \leq n$  let  $\mathcal{PST}^\mu(n)$  be the set of all primed, or marked, semistandard shifted tableaux  $PST$  obtained by numbering all the boxes of  $SF^\mu$  with entries taken from the set  $\{1', 1, 2', 2, \dots, n', n\}$ , subject to the total ordering  $1' < 1 < 2' < 2 < \dots < n' < n$ . The numbering must be such that the entries are:

- PST1 weakly increasing across each row from left to right;
- PST2 weakly increasing down each column from top to bottom;
- PST3 with no two identical unmarked entries in any column;
- PST4 with no two identical marked entries in any row;
- PST5 with no marked entries on the main diagonal.

The passage from  $ST^\mu(n)$  to  $\mathcal{PST}^\mu(n)$  is effected merely by adding marks to the entries of each  $ST \in \mathcal{ST}^\mu(n)$  in all possible ways that are consistent with PST1-5 to give some  $PST \in \mathcal{PST}^\mu(n)$ . The only entries for which any choice is possible are those in the lower left hand box at the beginning of each connected component of a ribbon strip. Thereafter in that connected component of the ribbon strip entries in the boxes of its horizontal portions are unmarked and those in the boxes of its vertical portions are marked. It should be noted that all the boxes on the main diagonal are necessarily at the lower left hand end of a connected component of a ribbon strip, but their entries remain unmarked by virtue of PST5. The marked weight of the tableau  $PST$  is then defined to be the vector  $wgt(PST) = (u_1, u_2, \dots, u_n / v_1, v_2, \dots, v_n)$ , where  $u_k$  and  $v_k$  are the number of times  $k$  and  $k'$ , respectively, appear in  $PST$  for  $k = 1, 2, \dots, n$ .

Let  $\mathbf{x} = (x_1, x_2, \dots, x_n)$  be a vector of  $n$  indeterminates and let  $\mathbf{w} = (w_1, w_2, \dots, w_n)$  be a vector of  $n$  non-negative integers. Then

$$\mathbf{x}^{\mathbf{w}} = x_1^{w_1} x_2^{w_2} \cdots x_n^{w_n}.$$

With this notation it is well known that each partition  $\lambda$  of length  $\ell(\lambda) \leq n$  specifies a Schur function  $s_\lambda(\mathbf{x})$  with combinatorial definition:

$$(2.1) \quad s_\lambda(\mathbf{x}) = \sum_{T \in \mathcal{T}^\lambda(n)} \mathbf{x}^{wgt(T)}$$

Similarly, each strict partition  $\mu$  of length  $\ell(\mu) \leq n$  specifies a Schur  $Q$ -function whose combinatorial definition takes the form:

$$(2.2) \quad Q_\mu(\mathbf{x}) = \sum_{ST \in \mathcal{ST}^\mu(n)} 2^{str(ST)} \mathbf{x}^{wgt(ST)}.$$

The corresponding Schur  $P$ -function takes the form:

$$(2.3) \quad P_\mu(\mathbf{x}) = \sum_{ST \in \mathcal{ST}^\mu(n)} 2^{str(ST) - \ell(\mu)} \mathbf{x}^{wgt(ST)}.$$

Let  $\mathbf{z} = (\mathbf{x}/\mathbf{y}) = (x_1, x_2, \dots, x_n / y_1, y_2, \dots, y_n)$ , where  $\mathbf{x}$  and  $\mathbf{y}$  are two vectors of  $n$  indeterminates, and let  $\mathbf{w} = (\mathbf{u}/\mathbf{v}) = (u_1, u_2, \dots, u_n / v_1, v_2, \dots, v_n)$  where  $\mathbf{u}$  and  $\mathbf{v}$  are two vectors of  $n$  non-negative integers. Then let  $\mathbf{z}^{\mathbf{w}} = (\mathbf{x}/\mathbf{y})^{(\mathbf{u}/\mathbf{v})} = \mathbf{x}^{\mathbf{u}} \mathbf{y}^{\mathbf{v}} = x_1^{u_1} \cdots x_n^{u_n} y_1^{v_1} \cdots y_n^{v_n}$ . With this notation each strict partition  $\mu$  of length  $\ell(\mu) \leq n$  serves to specify a generalised Schur  $P$ -function that may be denoted by  $P_\mu(\mathbf{x}/\mathbf{y})$  and defined by

$$(2.4) \quad P_\mu(\mathbf{x}/\mathbf{y}) = \sum_{PST \in \mathcal{PST}^\mu(n)} (\mathbf{x}/\mathbf{y})^{\text{wgt}(PST)}$$

Since the map back from  $PST \in \mathcal{PST}^\mu(n)$  to some  $|ST| \in \mathcal{ST}^\mu(n)$  is effected merely by deleting marks, and there are no marks on the main diagonal, it follows that

$$(2.5) \quad Q_\mu(\mathbf{x}) = 2^{\ell(\mu)} P_\mu(\mathbf{x}) \quad \text{with} \quad P_\mu(\mathbf{x}) = P_\mu(\mathbf{x}/\mathbf{x}).$$

It might be noted that  $s_\lambda(\mathbf{x})$ ,  $P_\mu(\mathbf{x})$  and  $Q_\mu(\mathbf{x})$  are nothing other than the specialisations  $P_\lambda(\mathbf{x}; 0)$ ,  $P_\mu(\mathbf{x}; -1)$  and  $Q_\mu(\mathbf{x}; -1)$ , respectively, of the Hall-Littlewood functions  $P_\mu(\mathbf{x}; t)$  and  $Q_\mu(\mathbf{x}; t)$ . In fact  $s_\lambda(\mathbf{x}) = P_\lambda(\mathbf{x}; 0) = Q_\lambda(\mathbf{x}; 0)$ , see Macdonald [M95] pp 208 and p225, and this is true for all partitions  $\lambda$ .

Rather than generalise  $P_\mu(\mathbf{x})$  we could equally well have generalised  $Q_\mu(\mathbf{x})$ . If we replace PST1-4 by identical conditions QST1-4, but drop the condition PST5, the corresponding marked shifted tableaux  $QST \in \mathcal{QST}^\mu(n)$ , with marks now allowed on the diagonal entries, serve to define

$$(2.6) \quad Q_\mu(\mathbf{x}/\mathbf{y}) = \sum_{QST \in \mathcal{QST}^\mu(n)} (\mathbf{x}/\mathbf{y})^{\text{wgt}(QST)}.$$

With this definition, the result analogous to (1.6) takes the form:

$$(2.7) \quad Q_\mu(\mathbf{x}/\mathbf{y}) = s_\lambda(\mathbf{x}) \prod_{1 \leq i \leq j \leq n} (x_i + y_j).$$

### 3. The Bijection

**3.1. Main Result.** The generalisation from  $P_\mu(\mathbf{x})$  to  $P_\mu(\mathbf{x}/\mathbf{y})$  allows us to formulate the following

**Theorem 3.1.** *Let  $\mu = \lambda + \delta$  be a strict partition of length  $\ell(\mu) = n$ , with  $\lambda$  a partition of length  $\ell(\lambda) \leq n$  and  $\delta = (n, n-1, \dots, 1)$ . In addition, let  $\mathbf{x} = (x_1, x_2, \dots, x_n)$  and  $\mathbf{y} = (y_1, y_2, \dots, y_n)$ . Then*

$$(3.1) \quad P_\mu(\mathbf{x}/\mathbf{y}) = s_{1^n}(\mathbf{x}) s_\lambda(\mathbf{x}) \prod_{1 \leq i < j \leq n} (x_i + y_j).$$

Here  $s_{1^n}(\mathbf{x}) = x_1 x_2 \cdots x_n$  is associated with the unmarked entries  $1, 2, \dots, n$  that must appear on the main diagonal of each  $PST \in \mathcal{PST}^\mu(n)$  in the case  $\ell(\mu) = n$ .

Our main result, is to provide a bijective proof of the above identity from which follow a number of corollaries. The case  $\lambda = 0$  is equivalent to an alternating sign matrix identity attributed to Robbins and Rumsey [RR86], proved combinatorially by Chapman [C01]. The case  $\mathbf{x} = \mathbf{y}$  is an example of Macdonald (Sec. III.8, Ex. 2) [M95]. The case  $\mathbf{y} = t\mathbf{x} = (tx_1, tx_2, \dots, tx_n)$  is equivalent to a Weyl denominator deformation Theorem due to Tokuyama [T88] for the Lie algebra  $gl(n)$  and proved combinatorially by Okada [O90].

It should be stressed that the above Theorem is restricted to the case of a strict partition  $\mu$  of length  $\ell(\mu) = n$ , although a similar result applies in the case  $\ell(\mu) = n-1$  which may be obtained from the above by dividing both sides by  $s_{1^n}(\mathbf{x}) = x_1 x_2 \cdots x_n$ .

**Proof of Theorem 3.1:** Given a primed semistandard shifted tableau, PST, of shape  $\mu = \lambda + \delta$ , we will show how to decompose it into a semistandard tableau of shape  $\lambda$  and a primed (not necessarily semistandard) shifted tableau of shape  $\delta$  satisfying: 1)  $k'$  appears only in column  $k$ ; 2)  $k$  appears only in row  $k$ , and; 3) there are no primed entries on the main diagonal.

Apply jeu de taquin for generalised marked shifted tableaux ([S87], [W84], [SS89], [M95], [HH92]) to the primed entries  $k'$  in turn (starting with the  $1'$ ) by moving them to the left as far as but no farther than the  $k$ th column. For this purpose we assume  $k'$  is less than  $i$  for  $i = 1, 2, \dots, k-1$ . If there is more than one  $k'$  we start with the highest one. In doing this we must always be careful not to violate PST4—thus

identical primed entries must be in different rows at all times even if they are separated by unprimed entries. Note that at each stage we can blank out all entries greater than  $k$  in the right hand portion and remove all columns to the left of the  $k$ th.

When the  $k$ 's have all been moved to their own column, the tableau that results will have unprimed elements on the main diagonal. Now permute the other entries so as to leave all the unprimed entries in their own rows. We can divide the resulting tableau at column  $n$  to give a primed semistandard shifted tableau of shape  $\delta$  and a semistandard tableau of shape  $\lambda$ .

To undo the above transformation, reverse the steps taken. First move all the primed entries to the top of their own columns. Then play jeu de taquin in reverse with primed entries  $k'$  taken in turn from bottom to top. These entries move in a south easterly direction with  $k'$  now assumed to be larger than  $i$  for  $i = 1, \dots, k - 1$  but less than  $j$  for  $j = k, k + 1, \dots$ , with the semistandardness conditions applying to all unprimed entries at all times.  $\diamond$

We can derive a number of corollaries of Theorem 3.1. We will derive a further corollary in Section 4.

Setting  $\lambda = 0$  in Theorem 3.1 we obtain the following corollary:

**Corollary 3.2.**

$$(3.2) \quad s_{1^n}(\mathbf{x}) \prod_{1 \leq i < j \leq n} (x_i + y_j) = P_\delta(\mathbf{x}/\mathbf{y}).$$

The case  $\mathbf{y} = t\mathbf{x} = (tx_1, tx_2, \dots, tx_n)$  is equivalent to a Weyl denominator deformation Theorem due to Tokuyama [T88] for the Lie algebra  $gl(n)$ . There is also a combinatorial proof due to Okada [O90].

**Corollary 3.3.**

$$(3.3) \quad \prod_{1 \leq i < j \leq n} (x_i + tx_j) s_\lambda(\mathbf{x}) = \sum_{ST \in ST^\mu} t^{hgt(ST)} (1+t)^{str(ST)-n} x^{wgt(ST)},$$

Finally, when  $\mathbf{x} = \mathbf{y}$  we derive a formula appearing in Macdonald (Sec. III.8, Ex. 2, p.259):

**Corollary 3.4.**

$$P_\mu(\mathbf{x}) = s_\lambda(\mathbf{x}) \prod_{1 \leq i < j \leq n} (x_i + x_j).$$

where  $\mu = \lambda + \delta$  with  $\ell(\mu) = n$ .

**3.2. Example.** Consider the case  $\mu = (9, 8, 6, 4, 3, 1)$  and the shifted standard tableau:

$$(3.4) \quad S = \begin{array}{cccccccc} \boxed{1} & \boxed{1} & \boxed{1} & \boxed{2} & \boxed{3} & \boxed{3} & \boxed{4} & \boxed{4} & \boxed{4} \\ & \boxed{2} & \boxed{2} & \boxed{2} & \boxed{3} & \boxed{4} & \boxed{5} & \boxed{5} & \boxed{5} \\ & & \boxed{3} & \boxed{4} & \boxed{4} & \boxed{4} & \boxed{5} & \boxed{6} & \\ & & & \boxed{4} & \boxed{5} & \boxed{5} & \boxed{6} & & \\ & & & & \boxed{5} & \boxed{6} & \boxed{6} & & \\ & & & & & \boxed{6} & & & \\ & & & & & & \boxed{6} & & \end{array} \in ST^{9,8,6,4,3,1}$$

Now let us assign 's to those entries for which it is essential; that is, for every entry lying immediately above the same entry and some of those for which it is optional (those entries off the main diagonal that are at the start of any continuous strip of equal entries).



(3.10)  $\rightarrow$

1	2'	3'	4'	1	1	4	4	4
	2	3'	4'	2	3	5'	5	5
		3	2	4	4	5	6	
			4	5'	5	6'		
				5	6'	6		
					6			

Now for the two 5's, the upper one first

(3.11)  $\rightarrow$

1	2'	3'	4'	1	1	5'	4	4
	2	3'	4'	2	3	4	5	5
		3	2	4	4	5	6	
			4	5'	5	6'		
				5	6'	6		
					6			

1	2'	3'	4'	1	5'	1	4	4
	2	3'	4'	2	3	4	5	5
		3	2	4	4	5	6	
			4	5'	5	6'		
				5	6'	6		
					6			

1	2'	3'	4'	5'	1	1	4	4
	2	3'	4'	2	3	4	5	5
		3	2	4	4	5	6	
			4	5'	5	6'		
				5	6'	6		
					6			

and then the other 5'

(3.12)  $\rightarrow$

1	2'	3'	4'	5'	1	1	4	4
	2	3'	4'	2	3	4	5	5
		3	2	5'	4	5	6	
			4	4	5	6'		
				5	6'	6		
					6			

1	2'	3'	4'	5'	1	1	4	4
	2	3'	4'	5'	3	4	5	5
		3	2	2	4	5	6	
			4	4	5	6'		
				5	6'	6		
					6			

Finally, for the two 6's, first the upper one

(3.13)  $\rightarrow$

1	2'	3'	4'	5'	1	1	4	4
	2	3'	4'	5'	3	4	5	5
		3	2	2	4	6'	6	
			4	4	5	5		
				5	6'	6		
					6			

1	2'	3'	4'	5'	1	1	4	4
	2	3'	4'	5'	3	6'	5	5
		3	2	2	4	4	6	
			4	4	5	5		
				5	6'	6		
					6			

1	2'	3'	4'	5'	1	1	4	4
	2	3'	4'	5'	6'	3	5	5
		3	2	2	4	4	6	
			4	4	5	5		
				5	6'	6		
					6			

(3.14)  $\rightarrow$

1	2'	3'	4'	5'	6'	1	4	4
	2	3'	4'	5'	1	3	5	5
		3	2	2	4	4	6	
			4	4	5	5		
				5	6'	6		
					6			

and then the final 6'

(3.15)

Finally notice that in each of the first 6 columns the entry on the main diagonal is always unprimed and we permute the other entries so as to leave all the unprimed entries in their own rows. This operation still leaves all the primed entries in their own column.

(3.16)

This results in a primed semistandard shifted tableau juxtaposed with a semistandard Young tableau:

(3.17)

Note that at an individual stage, say the shifting of the 5's, we can blank out the entries greater than 5' in the right hand portion and also strip off the columns to the left of the first column that contains a 5'. This reduces the problem to a classical jeu de taquin problem. We start with

(3.18)

Now play the jeu du taquin

(3.19)

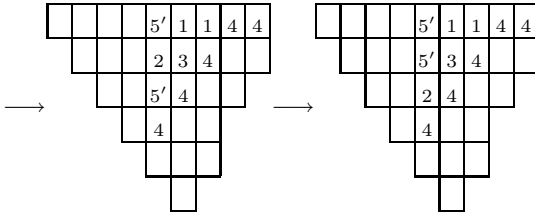

(3.20)  $\rightarrow$  

### 4. Connection to Alternating Sign Matrices

In this section we show how to move from *PST* to alternating sign matrices. Using this relationship, a result of Chapman [C01] is a straightforward consequence of Theorem 3.1.

An alternating sign matrix (ASM) is an  $n \times n$  matrix filled with 0's, 1's, and  $-1$ 's such that the first and last nonzero entries of each row and column are 1's and the nonzero entries within a row or column alternate in sign. There is a famous formula, conjectured by Mills, Robbins, and Rumsey [MRR83] and proved by Zeilberger [Z96], that counts the number of ASM of size  $n$  as  $\prod_{j=0}^{n-1} \frac{(3j+1)!}{(n+j)!}$ . See also Bressoud [B99].

We work with a generalisation of ASM called  $\mu$ -ASM [O93] that can be associated with shifted tableaux. Given a partition  $\mu$  with distinct parts and such that  $\ell(\mu) = n$  and  $\mu_1 \leq n$ , the set of  $\mu$ -alternating sign matrices,  $\mu$ -ASM, is the set of  $n \times m$  matrices that satisfy the following conditions:

- ASM1  $a_{iq} \in \{-1, 0, 1\}$  for  $1 \leq i \leq n, 1 \leq q \leq m$ ;
- ASM2  $\sum_{q=p}^m a_{iq} \in \{0, 1\}$  for  $1 \leq i \leq n, 1 \leq p \leq m$ ;
- ASM3  $\sum_{i=j}^n a_{iq} \in \{0, 1\}$  for  $1 \leq j \leq n, 1 \leq q \leq m$
- ASM4  $\sum_{q=1}^m a_{iq} = 1$  for  $1 \leq i \leq n$ ;
- ASM5  $\sum_{i=1}^n a_{iq} = 1$  if  $q = \mu_j$  for some  $j$ ; or  $\sum_{i=1}^n a_{iq} = 0$  otherwise; for  $1 \leq q \leq m$ .

The bijection to  $\mu$ -ASM is a special case of our bijection between  $\mu$ -UASM and symplectic shifted tableaux [HK03]. Briefly, associate to each primed shifted tableaux *PST* of shape  $\mu$  with  $\ell(\mu) = n$  and  $\mu_1 = m$  an  $n \times m$  matrix filled with the entries from the primed shifted tableaux and with zeros such that if there is an  $i$  (resp.  $i'$ ) on diagonal  $j$  of the *PST* (where the main diagonal is diagonal 1 and the last box in the first row is diagonal  $\mu_1 = m$ ), then there is an  $i$  (resp.  $i'$ ) in row  $i$  (resp.  $i$ ), column  $j$  of the matrix. All other positions are zero.

For example, given a primed shifted tableau of shape  $\mu = 9, 8, 6, 4, 3, 1$ :

(4.1)  $PST =$ 

1	1	2'	3'	3	4	4	4
2	2	2	3'	4'	5'	5	5
3	4'	4	4	5	6		
4	5'	5	6'				
5	6'	6					
6							

$$\implies M(PST) = \begin{bmatrix} 1 & 1 & 1 & 0 & 0 & 0 & 0 & 0 & 0 \\ 2 & 2 & 2 & 2' & 0 & 0 & 0 & 0 & 0 \\ 3 & 0 & 0 & 3' & 3' & 3 & 0 & 0 & 0 \\ 4 & 4' & 4 & 4 & 4' & 0 & 4 & 4 & 4 \\ 5 & 5' & 5 & 0 & 5 & 5' & 5 & 5 & 0 \\ 6 & 6' & 6 & 6' & 0 & 6 & 0 & 0 & 0 \end{bmatrix}$$

This can be converted into a  $\mu$ -alternating sign matrix by replacing the rightmost entry of each continuous sequence of nonzero entries by a 1 and each zero immediately to the left of a nonzero entry by  $-1$ , leaving all other entries 0.

$$(4.2) \quad A = \begin{bmatrix} 0 & 0 & 1 & 0 & 0 & 0 & 0 & 0 & 0 \\ 0 & 0 & 0 & 1 & 0 & 0 & 0 & 0 & 0 \\ 1 & 0 & -1 & 0 & 0 & 1 & 0 & 0 & 0 \\ 0 & 0 & 0 & 0 & 1 & -1 & 0 & 0 & 1 \\ 0 & 0 & 1 & -1 & 0 & 0 & 0 & 1 & 0 \\ 0 & 0 & 0 & 1 & -1 & 1 & 0 & -1 & 0 \end{bmatrix} \in \mathcal{A}^{986431}$$

Square ice provides a further refinement of the above bijection. Square ice is a directed graph that models the orientation of oxygen and hydrogen molecules in frozen water. The vertices are laid out in an  $n \times n$  grid and each vertex has two incoming and two outgoing edges in a north, south, east, west orientation. At each vertex there are six possible orientations of the four directed edges. The horizontal orientation (with both horizontal edges directed in) corresponds to  $+1$  and the vertical orientation (with both vertical edges directed in) corresponds to  $-1$ ; the other four orientations correspond to 0. Accordingly there are northwest zeros (with edges pointing in the north and west directions), southwest zeros, northeast zeros, and southeast zeros. Northwest zeros are those whose nearest nonzero neighbour to the right, if it has one, is  $-1$ , and whose nearest nonzero neighbour below is 1. Southwest zeros are those whose nearest nonzero neighbour to the right, if it has one, is  $-1$ , and whose nearest nonzero neighbour below, if it has one, is  $-1$ . Northeast zeros are those whose nearest nonzero neighbour to the right is 1, and whose nearest nonzero neighbour below is 1. Southeast zeros are those whose nearest nonzero neighbour to the right is 1, and whose nearest nonzero neighbour below, if it has one, is  $-1$ .

<i>WE</i>	<i>NS</i>	<i>NE</i>	<i>SW</i>	<i>NW</i>	<i>SE</i>
$\begin{array}{c} \uparrow \\ \rightarrow \cdot \leftarrow \\ \downarrow \end{array}$	$\begin{array}{c} \downarrow \\ \leftarrow \cdot \rightarrow \\ \uparrow \end{array}$	$\begin{array}{c} \uparrow \\ \rightarrow \cdot \rightarrow \\ \uparrow \end{array}$	$\begin{array}{c} \downarrow \\ \leftarrow \cdot \leftarrow \\ \downarrow \end{array}$	$\begin{array}{c} \uparrow \\ \leftarrow \cdot \leftarrow \\ \uparrow \end{array}$	$\begin{array}{c} \downarrow \\ \rightarrow \cdot \rightarrow \\ \downarrow \end{array}$
1	$-1$	0	0	0	0

The equivalent expression in square ice is

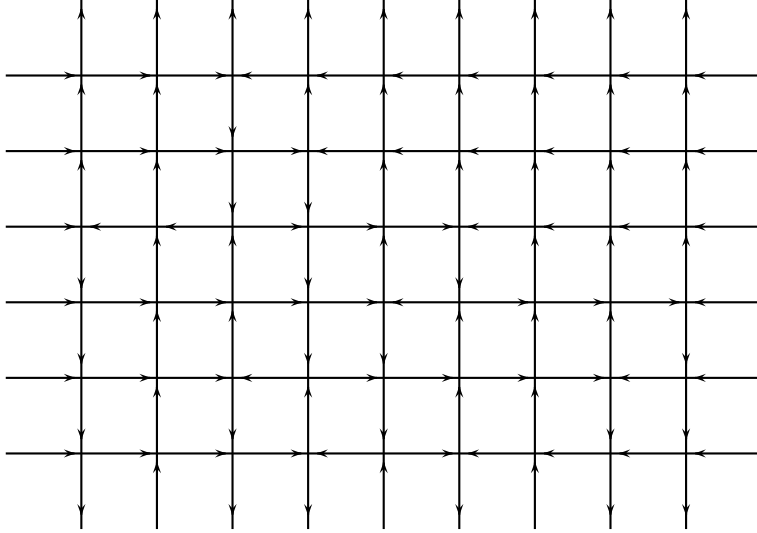

We can also derive a “compass points” matrix:

$$(4.4) \quad CM = \begin{bmatrix} NE & NE & WE & NW & NW & NW & NW & NW & NW \\ NE & NE & SE & WE & NW & NW & NW & NW & NW \\ WE & NW & NS & SE & NE & WE & NW & NW & NW \\ SE & NE & NE & SE & WE & NS & NE & NE & WE \\ SE & NE & WE & NS & SE & NE & NE & WE & SW \\ SE & NE & SE & WE & NS & WE & NW & SW & SW \end{bmatrix}$$

The entries  $NE$  in the  $k$ th row may be associated with an entry  $k$  in  $PST$  and correspondingly to a weight factor  $x_k$ . The entries  $SE$  in the  $k$ th row may be associated with an entry  $k'$  in  $PST$  and correspondingly to a weight factor  $y_k$ . The entries  $NS$  in the  $k$ th row are to be associated with the two possible labels  $k$  and  $k'$  of the first box of each connected component of  $\text{str}_k(PST)$  other than the one starting on the main diagonal. Correspondingly each  $NS$  in row  $k$  is associated with a weight factor  $(x_k + y_k)$ . It should be pointed out that the above weighting excludes the weight  $x_1 x_2 \cdots x_n$  arising from the entries  $1, 2, \dots, n$  on the main diagonal of each  $PST$ .

Combining the weight factors we have a total weight associated with each  $A \in \mathcal{A}^\mu$  given by

$$(4.5) \quad \sum_{A \in \mathcal{A}^\mu} \prod_{k=1}^n x_k^{NE_k(A)} y_k^{SE_k(A)} (x_k + y_k)^{NS_k(A)}$$

**Corollary 4.1.**

$$\prod_{1 \leq i < j \leq n} (x_i + y_j) s_{1^n}(\mathbf{x}) s_\lambda(\mathbf{x}) = \sum_{A \in \mathcal{A}^\mu} \prod_{k=1}^n x_k^{NE_k(A)} y_k^{SE_k(A)} (x_k + y_k)^{NS_k(A)}.$$

where  $\mu = \lambda + \delta$ .

This generalises a result of Chapman [C01]. In his original paper he weights by column instead of row so the parameters in his paper correspond to the transpose matrix.

**Corollary 4.2** (Chapman [C01]).

$$\prod_{1 \leq i < j \leq n} (x_i + y_j) = \sum_{A \in \mathcal{A}} \prod_{k=1}^n x_k^{NE_k(A)} y_k^{SE_k(A)} (x_k + y_k)^{NS_k(A)}.$$

## 5. Other Directions

Okada [O93] contains a number of  $t$ -deformations of Weyl's denominator formula for root systems  $B_n$ ,  $C_n$ , and  $D_n$ . These are similar in form to the Robbins and Rumsey [RR86] formula, (1.3), which can be seen as a deformation for  $A_n$ . Deformations for  $B_n$  and  $C_n$  also appear in Simpson [S97a][S97b] and Hamel and King [HK02]. We anticipate that the methods presented here would also apply to these root systems and would enable combinatorial proofs of  $y$  generalisations of these  $t$ -deformations similar in spirit to (1.4), Chapman's generalisation [C01] of Robbins and Rumsey.

## References

- [B99] D.M. Bressoud, *Proof and Confirmations*, MAA, Wash., D.C., 1999.
- [B01] D.M. Bressoud, *Three alternating sign matrix identities in search of bijective proofs*, Adv. Appl. Math., **27** (2001), 289–297.
- [C01] R. Chapman, *Alternating sign matrices and tournaments*, Adv. Appl. Math. **27** (2001), 318–335.
- [HK02] A.M. Hamel, R.C. King, *Symplectic shifted tableaux and deformations of Weyl's denominator formula for  $sp(2n)$* , Journal of Algebraic Combinatorics, **16**, no. 3 (2002), 269–300.
- [HK03] A.M. Hamel, R.C. King, *U-turn alternating sign matrices, symplectic shifted tableaux, and their weighted enumeration*, preprint, 2003.
- [HH92] P.N. Hoffman, J.F. Humphreys, *Projective Representations of the Symmetric Groups:  $Q$ -Functions and Shifted Tableaux*, Oxford: Oxford University Press, 1992.
- [M95] I.G. Macdonald, *Symmetric Functions and Hall Polynomials*, 2nd. ed. Oxford: Oxford University Press, 1995.
- [MRR83] W.H. Mills, D.P. Robbins, H. Rumsey, *Alternating sign matrices and descending plane partitions*, J. Comb. Theory A **34** (1983), 340–359.
- [O90] S. Okada, *Partially strict shifted plane partitions*, J. Comb. Theory A **53** (1990), 143–156.
- [O93] S. Okada, *Alternating sign matrices and some deformations of Weyl's denominator formula*, J. Algebraic Comb. **2** (1993), 155–176.
- [RR86] D.P. Robbins, H. Rumsey, *Determinants and alternating sign matrices*, Adv. Math. **62** (1986), 169–184.
- [S87] B.E. Sagan, *Shifted tableaux, Schur  $Q$ -functions and a conjecture fo Stanley*, J. Combin. Theory A **45** (1987), 62–103.
- [SS89] B.E. Sagan, R.P. Stanley, *Robinson Schensted algorithms for skew tableaux*, J. Combin. Theory A **55** (1990), 161–193.
- [S97a] T. Simpson, *Three generalizations of Weyl's denominator formula*, Elect. J. Combin. **3** (1997), # R12.
- [S97b] T. Simpson, *Another deformation of Weyl's denominator formula*, J. Combin. Theory A **77** (1997), 349–356.
- [T88] T. Tokuyama, *A generating function of strict Gelfand patterns and some formulas on characters of general linear groups*, J. Math. Soc. Japan **40** (1988), 671–685.
- [W84] D.R. Worley, *A theory of shifted Young tableaux*, Ph.D. thesis, M.I.T., 1984.
- [Z96] D. Zeilberger, *A proof of the alternating sign matrix conjecture*, Elect. J. Comb. **3** (1996), R13.

DEPARTMENT OF PHYSICS AND COMPUTER SCIENCE, WILFRID LAURIER UNIVERSITY, WATERLOO, ONTARIO N2L 3C5, CANADA

*E-mail address:* ahamel@wlu.ca

SCHOOL OF MATHEMATICS, UNIVERSITY OF SOUTHAMPTON, SOUTHAMPTON SO17 1BJ, ENGLAND

*E-mail address:* R.C.King@maths.soton.ac.uk



## The Octahedron Recurrence and $\mathfrak{gl}_n$ Crystals

André Henriques and Joel Kamnitzer

**Abstract.** *We study the hives of Knutson, Tao, and Woodward by means of a modified octahedron recurrence. We define a tensor category where tensor product is given by hives and where the associator and commutor are defined using our recurrence. We then prove that this category is equivalent to the category of crystals for the Lie algebra  $\mathfrak{gl}_n$ . The proof of this equivalence uses a new connection between the octahedron recurrence and the Jeu de Taquin and Schützenberger involution procedures on Young Tableaux.*

**Résumé.** *Nous étudions les hives de Knutson, Tao, et Woodward avec une récurrence octaèdre modifiée. Nous définissons une catégorie tensorielle où le produit tensoriel est donné par les hives et où l'associateur et le commuteur sont définies en termes de notre récurrence. Nous montrons que cette catégorie est équivalente à la catégorie des cristaux pour l'algèbre de Lie  $\mathfrak{gl}_n$ . La preuve de cette équivalence emploie une connexion nouvelle entre la récurrence d'octaèdre et, les procédures de Jeu de Taquin et de l'involution de Schützenberger sur les tableaux de Young.*

### 1. Hives

In [KTW], Knutson, Tao, and Woodward introduced hives for studying tensor product multiplicities of  $\mathfrak{gl}_n$  representations. Consider the triangle  $\{(x, y, z) : x + y + z = n, x, y, z \geq 0\}$ . This has  $\binom{n+2}{2}$  integer points; call this finite set  $\Delta_n$ . We will draw it in the plane and put  $(n, 0, 0)$  at the lower left,  $(0, 0, n)$  at the top, and  $(0, n, 0)$  in the lower right.

Let  $P$  be a function  $P : \Delta_n \rightarrow \mathbb{Z}$ . We say that  $P$  satisfies the *hive condition* if for any unit rhombus in a hive, the sum across the short diagonal is greater than the sum across the long diagonal.

A *hive* is an equivalence class of functions satisfying the hive condition, where two functions are considered to be equivalent if their difference is a constant function. We will usually picture a hive in terms of its representative that takes the value 0 at  $(0, 0, n)$ .

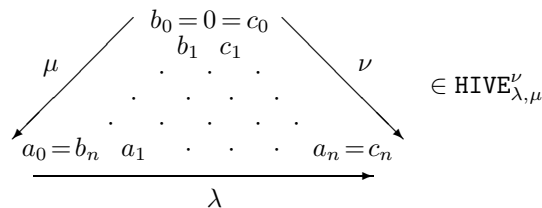

1991 *Mathematics Subject Classification.* Primary 05E10.

*Key words and phrases.* hives, crystals, tableaux.

The second author was supported by an NSERC postgraduate scholarship.

By adding together rhombus inequalities along the bottom of the hive, we see that  $(a_1 - a_0, a_2 - a_1, \dots, a_n - a_{n-1})$  is a weakly decreasing sequence of integers. Similarly, the sides labelled by  $b$  and  $c$  give weakly decreasing sequences of integers.

Let  $\Lambda_+$  denote the set of weakly decreasing sequences of integers of length  $n$ . We can identify  $\Lambda_+$  with the set of dominant weights of  $\mathfrak{gl}_n$ .

For  $\lambda, \mu, \nu \in \Lambda_+$ , let  $\text{HIVE}_{\lambda\mu}^\nu$  denote the set of hives of size  $n$  such that

- the difference on the bottom  $(a_1 - a_0, a_2 - a_1, \dots, a_n - a_{n-1}) = \lambda$
- the differences on the upper left side  $(b_1 - b_0, b_2 - b_1, \dots, b_n - b_{n-1}) = \mu$
- the differences on the upper right side  $(c_1 - c_0, c_2 - c_1, \dots, c_n - c_{n-1}) = \nu$

**Example 1.1.** We will use the following two examples of hives throughout the paper:

$$T = \begin{array}{ccc} & 0 & \\ & 2 & 3 \\ 4 & 5 & 6 \\ 5 & 7 & 8 & 8 \end{array} \in \text{HIVE}_{(2,1,0),(2,2,1)}^{(3,3,2)} \quad U = \begin{array}{ccc} & 0 & \\ & 1 & 2 \\ 1 & 3 & 4 \\ 1 & 3 & 4 & 5 \end{array} \in \text{HIVE}_{(2,1,1),(1,0,0)}^{(2,2,1)}$$

In [KTW], Knutson, Tao, and Woodward define a ring with basis  $b_\lambda$  for  $\lambda \in \Lambda_+(\mathfrak{gl}_n)$  and multiplication:

$$b_\lambda b_\mu = \sum_{\nu} c_{\lambda\mu}^\nu b_\nu$$

where  $c_{\lambda\mu}^\nu$  is the size of the set  $\text{HIVE}_{\lambda\mu}^\nu$ . They then prove that their ring is isomorphic to the representation ring of  $\mathfrak{gl}_n$ . The most difficult step in their proof is to show that their ring is associative.

To prove this associativity they use the octahedron recurrence of [RR] to construct a bijection:

$$(1.1) \quad \bigcup_{\delta} \text{HIVE}_{\lambda\delta}^\rho \times \text{HIVE}_{\mu\nu}^\delta \implies \bigcup_{\gamma} \text{HIVE}_{\lambda\mu}^\gamma \times \text{HIVE}_{\gamma\nu}^\rho$$

The purpose of this paper is to modify the octahedron recurrence in order to construct a bijection:

$$(1.2) \quad \text{HIVE}_{\lambda\mu}^\nu \implies \text{HIVE}_{\mu\lambda}^\nu$$

and to understand the structure of these bijections. This structure is most easily seen as giving us an associator and a commutor for a certain tensor category **Hives** whose simple objects are indexed by  $\Lambda_+$  and whose tensor product is defined using hives. For the purposes of the present paper, a tensor category is a category with a tensor product along with a natural isomorphism called the *associator* making the tensor product associative and a natural isomorphism called the *commutor* making the tensor product commutative.

**1.1. The category Hives.** We now define the category **Hives**. An object in **Hives** is not a hive; rather an object  $A$  is a choice of finite set  $A_\lambda$  for each  $\lambda \in \Lambda_+$  such that only finitely many  $A_\lambda$  are non-empty. A morphism from  $A, B$  is just a set map from  $A_\lambda$  to  $B_\lambda$  for each  $\lambda$ .

We think of  $A$  as being a representation of  $\mathfrak{gl}_n$  along with a direct sum decomposition into irreducible subrepresentations with the elements of  $A_\lambda$  labelling those summands isomorphic to  $V_\lambda$ .

Now we use our hives to define the tensor product on the category. We define:

$$(A \otimes B)_\nu = \bigcup_{\lambda, \mu} A_\lambda \times B_\mu \times \text{HIVE}_{\lambda\mu}^\nu$$

Note that:

$$\begin{aligned} (A \otimes (B \otimes C))_\rho &= \bigcup_{\delta, \lambda, \mu, \nu} A_\lambda \times B_\mu \times C_\nu \times \text{HIVE}_{\lambda\delta}^\rho \times \text{HIVE}_{\mu\nu}^\delta \\ ((A \otimes B) \otimes C)_\rho &= \bigcup_{\gamma, \lambda, \mu, \nu} A_\lambda \times B_\mu \times C_\nu \times \text{HIVE}_{\lambda\mu}^\gamma \times \text{HIVE}_{\gamma\nu}^\rho \end{aligned}$$

So in order to define a natural isomorphism  $A \otimes (B \otimes C) \rightarrow (A \otimes B) \otimes C$  (an associator) we need a bijection:

$$\bigcup_{\delta} \text{HIVE}_{\lambda\delta}^{\rho} \times \text{HIVE}_{\mu\nu}^{\delta} \implies \bigcup_{\gamma} \text{HIVE}_{\lambda\mu}^{\gamma} \times \text{HIVE}_{\gamma\nu}^{\rho}$$

Similarly, to make a natural isomorphism  $A \otimes B \rightarrow B \otimes A$  (a commutor) we need a bijection:

$$\text{HIVE}_{\lambda\mu}^{\nu} \implies \text{HIVE}_{\mu\lambda}^{\nu}$$

To construct these bijections we now introduce the octahedron recurrence.

### 2. The Octahedron Recurrence

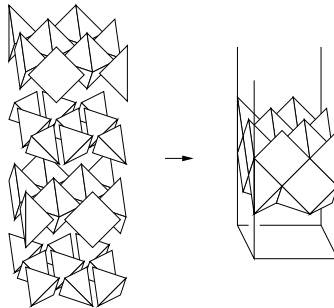

FIGURE 1. The tiling of space-time.

Fix  $m, n \in \mathbb{Z}_{>0}$ . Let us call *space-time* the space  $Y = [0, m] \times [0, n] \times \mathbb{R}$ . It contains the lattice  $\mathcal{L} = \{(x, y, t) \in \mathbb{Z}^3 \cap Y : x + y + z \text{ is even}\}$  on which the recurrence will take place.  $Y$  has two compact spatial dimensions and one time dimension. The lattice  $\mathcal{L}$  is the set of vertices of a tiling of  $Y$  by tetrahedra, octahedra, 1/2-octahedra, and 1/4-octahedra as shown in Figure 1. The tetrahedra are given by

$$\begin{aligned} \text{conv}\{(x, y, t), (x + 1, y + 1, t), (x + 1, y, t + 1), (x, y + 1, t + 1)\}, & \quad x + y + t \text{ even,} \\ \text{conv}\{(x + 1, y, t), (x, y + 1, t), (x, y, t + 1), (x + 1, y + 1, t + 1)\}, & \quad x + y + t \text{ odd,} \end{aligned}$$

while the octahedra, 1/2-octahedra and 1/4-octahedra are given by

$$Y \cap \text{conv}\{(x + 1, y, t), (x, y + 1, t), (x, y, t + 1), (x - 1, y, t), (x, y - 1, t), (x, y, t - 1)\},$$

for  $x + y + t$  odd.

A *section* is a connected subcomplex  $S$  of the 2-skeleton of the above tiling which contains exactly one point over each  $(x, y)$ . In particular,  $S$  is the graph  $S = \{(x, y, h(x, y))\}$  of a continuous map  $h : [0, m] \times [0, n] \rightarrow \mathbb{R}$ . A point  $(x, y, t) \in \mathcal{L}$  is said to be in the *future* of a section  $S$  if there exists  $(x, y, t') \in S$  with  $t' \leq t$ .

A *state* of a subset  $A \subset Y$  is an integer valued function  $f : A \cap \mathcal{L} \rightarrow \mathbb{Z}$ . In particular we may speak of the state of a section. The state  $f$  of a section  $S$  determines the state (again denoted by  $f$ ) of the set of all points in its future, according to the following modified octahedron recurrence:

$$(2.1) \quad f(x, y, t + 1) =$$

$$\max \left( f(x+1, y, t) + f(x-1, y, t), f(x, y+1, t) + f(x, y-1, t) \right) - f(x, y, t-1)$$

$$\begin{array}{ll} f(x+1, y, t) + f(x-1, y, t) - f(x, y, t-1) & \text{if } 0 < x < m, 0 < y < n, \\ f(x, y+1, t) + f(x, y-1, t) - f(x, y, t-1) & \text{if } 0 < x < m, y = 0 \text{ or } n, \\ f(x+1, y, t) + f(x, y+1, t) - f(x, y, t-1) & \text{if } 0 < y < n, x = 0 \text{ or } m, \\ f(x+1, y, t) + f(x, y+1, t) - f(x, y, t-1) & \text{if } (x, y) = (0, 0), \\ f(x+1, y, t) + f(x, y-1, t) - f(x, y, t-1) & \text{if } (x, y) = (0, n), \\ f(x-1, y, t) + f(x, y+1, t) - f(x, y, t-1) & \text{if } (x, y) = (m, 0), \\ f(x-1, y, t) + f(x, y-1, t) - f(x, y, t-1) & \text{if } (x, y) = (m, n). \end{array}$$

So we have one rule if our new point is in the interior (this is the recurrence in [KTW] which is the tropicalization of the original octahedron recurrence in [RR]), another rule if it lies on a wall, and a third if it lies on a vertical edge. These rules can be seen in Figure 2.

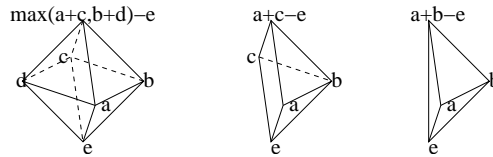

FIGURE 2. The modified octahedron recurrence.

**2.1. The hive Condition.** We want to use the octahedron recurrence to define operations on hives. We therefore need to understand how the hive condition propagates through the octahedron recurrence. A *rhombus* in  $Y$  is a subcomplex consisting of two coplanar unit triangles touching each other by one edge. A rhombus  $R$  has two obtuse vertices and two acute vertices. Given a state  $f$ , we say that  $f$  satisfies the *hive condition* at  $R$  if  $f(\text{obtuse vertex}) + f(\text{other obtuse vertex}) \geq f(\text{acute vertex}) + f(\text{other acute vertex})$ . We say that  $f$  satisfies the hive condition on a section  $S$  if it satisfies the above inequality for all rhombi  $R \subset S$ .

Let  $S, S'$  be two sections with  $S'$  in the future of  $S$ . Let  $f$  be a state on  $S$  which is extended to a state of  $S'$  by the octahedron recurrence. Suppose that  $f$  satisfies the hive condition on  $S$ . We will now investigate the problem of which hive conditions will be satisfied by  $f$  on  $S'$ .

A *wavefront* is a subcomplex  $W \subset Y$  of the form

$$W = \{(x, y, t) \in Y \mid \exists k \in \mathbb{Z} : |t + 2k(m+n) + c| = x + y\}$$

or  $W = \{(x, y, t) \in Y \mid \exists k \in \mathbb{Z} : |t + 2k(m+n) + c| = x + (n - y)\},$

for some constant  $c$ . We gave wavefronts their name because one can think of them as world-surfaces of a linear waves propagating at speed 1, and reflecting on the corners of space. A wave front  $W$  is composed of big rhombi, touching each other at their acute vertices. Call these acute vertices the *cutpoints* of  $W$ .

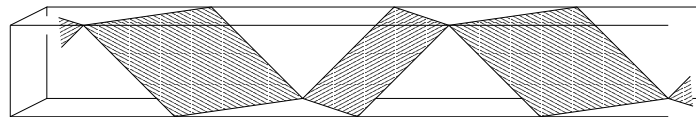

A wavefront.

We say that a section  $S$  is *transverse* to a wavefront  $W$  if  $W \cap S$  is one dimensional and if no cutpoint of  $W$  is contained in  $S$ . Given an edge  $\alpha \subset W \setminus \partial Y$ , let  $R_\alpha$  be the rhombus that has  $\alpha$  as its small diagonal and that is not contained in  $W$ .





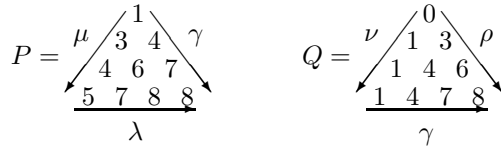

**Proposition 3.2** ([KTW]). *The map:*

$$\bigcup_{\delta} \text{HIVE}_{\lambda\delta}^{\rho} \times \text{HIVE}_{\mu\nu}^{\delta} \rightarrow \bigcup_{\gamma} \text{HIVE}_{\lambda\mu}^{\gamma} \times \text{HIVE}_{\gamma\nu}^{\rho}$$

$$(T, U) \mapsto (P(T, U), Q(T, U))$$

is a bijection.

Now for  $A, B, C \in \text{Hives}$  we can define the associator:

$$\alpha_{A,B,C} : A \otimes (B \otimes C) \rightarrow (A \otimes B) \otimes C$$

$$(a, (b, c, U), T) \mapsto ((a, b, P), c, Q)$$

This map is an isomorphism by Proposition 3.2.

**3.2. Commutor.** We also have a commutor in Hives. Let  $P \in \text{HIVE}_{\lambda\mu}^{\nu}$ . Let  $S = \{(x, y, t) : x + y = t \leq n\}$  (half of a section). Embed  $P$  into  $S$  by the map  $(x, y, z) \mapsto (y, z, n - x)$  and use the octahedron recurrence to evolve this state to the region  $A = \{(x, y, t) : x + y \leq t \leq 2n - x - y\}$  (a big 1/4-octahedron). Consider an embedding of  $\Delta_n$  into the spacetime by  $(x, y, z) \mapsto (y, z, n + x)$ . This gives us  $P^* : \Delta_n \rightarrow \mathbb{Z}$ . It's again possible to check that a wavefront  $W$  is transverse to the bottom face  $S$  if and only if it is transverse to the top face. We apply Lemma 2.1 and deduce that  $P$  is a hive if and only if  $P^*$  is.

By examining the octahedron recurrence on the boundary of the spacetime, we see that  $P^*$  has boundary  $\mu, \lambda, \nu$  and hence  $P^* \in \text{HIVE}_{\mu\lambda}^{\nu}$ .

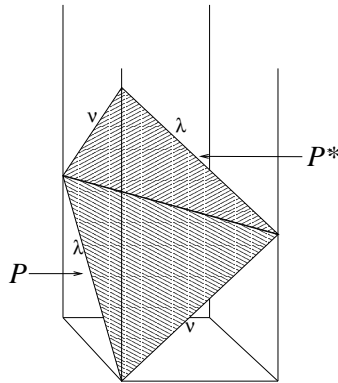
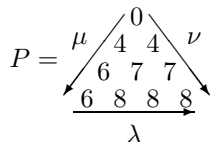

FIGURE 4. The old hive  $P$  and the new hive  $P^*$ .

**Example 3.3.** Consider the hive:



We follow the above procedure and give a state to  $A$ . Here is the state as shown by a sequence of horizontal slices through  $A$ :

$$8 \quad 8 \quad 8 \quad 6 \quad 5 \quad 2 \quad -2$$

$$7 \quad 7 \quad 7 \quad 7 \quad 4 \quad 0 \quad 0$$

$$4 \quad 4 \quad 4 \quad 4 \quad 0 \quad 0 \quad 0$$

Hence the resulting  $P^*$  is:

$$P^* = \begin{array}{c} \lambda \quad \quad \quad -2 \quad \quad \nu \\ \swarrow \quad \quad \quad \quad \quad \searrow \\ 0 \quad \quad \quad 2 \quad \quad \quad \\ \swarrow \quad \quad \quad \quad \quad \searrow \\ 0 \quad \quad \quad 4 \quad \quad \quad 5 \\ \swarrow \quad \quad \quad \quad \quad \searrow \\ 0 \quad \quad \quad 4 \quad \quad \quad 6 \quad \quad \quad 6 \\ \mu \end{array}$$

**Proposition 3.4.** *The map:*

$$\begin{aligned} \text{HIVE}_{\lambda\mu}^\nu &\rightarrow \text{HIVE}_{\mu\lambda}^\nu \\ P &\mapsto P^* \end{aligned}$$

is a bijection.

We define the commutor  $\sigma_{A,B}$  in Hives by:

$$(3.1) \quad \begin{aligned} \sigma_{A,B} : A \otimes B &\rightarrow B \otimes A \\ (a, b, P) &\mapsto (b, a, P^*) \end{aligned}$$

### 4. $\mathfrak{gl}_n$ Crystals

We would like to relate the category Hives to  $\mathfrak{gl}_n$  crystals. We will study  $\mathfrak{gl}_n$  crystals using tableaux. We begin by recalling this connection. These results have generally appeared elsewhere, see for example [Sh].

**Proposition 4.1.** *There exists a crystal structure on the set  $B_\lambda$  of semistandard Young tableaux of shape  $\lambda$ . Moreover this family  $\{B_\lambda\}$  is the unique closed family of irreducible highest weight  $\mathfrak{gl}_n$  crystals.*

If  $T, U$  are two tableaux of shape  $\lambda$  and  $\mu$  respectively, we can form their skew product denoted  $T \star U$  which is the skew tableau made by putting  $U$  up and to the right of  $T$ . Denote the resulting skew shape by  $\lambda \star \mu$ .

**Example 4.2.**

$$\text{If: } \hat{T} = \begin{array}{|c|c|} \hline 1 & 3 \\ \hline 2 & \\ \hline \end{array} \quad \hat{U} = \begin{array}{|c|c|} \hline 1 & 2 \\ \hline 2 & \\ \hline 3 & \\ \hline \end{array} \quad \text{then: } \hat{T} \star \hat{U} = \begin{array}{|c|c|} \hline & 1 & 2 \\ \hline & 2 & \\ \hline & 3 & \\ \hline 1 & 3 & \\ \hline 2 & & \\ \hline \end{array}$$

Given a skew tableau  $X$ , let  $J(X)$  be the tableau that results by applying Jeu de Taquin to  $X$ . Suppose that  $X$  and  $Y$  are skew tableaux of the same shape. Choose a particular order for performing Jeu de Taquin. Then  $X$  and  $Y$  are said to be *dual equivalent* if the shapes of  $X$  and  $Y$  are the same throughout the Jeu de Taquin process.

We have the following connection between Jeu de Taquin and tensor product:

**Theorem 4.1.** *The map  $B_\lambda \otimes B_\mu \rightarrow \cup B_\nu$  by  $(T, U) \mapsto J(T \star U)$  is a map of crystals. Moreover,  $(T, U)$  and  $(T', U')$  are in the same component of  $B_\lambda \otimes B_\mu$  iff  $T \star U$  and  $T' \star U'$  are dual equivalent.*

**4.1. Category of crystals.** The category  $\mathfrak{gl}_n$ -Crystals is the category whose objects are crystals  $B$  such that each connected component of  $B$  is isomorphic to some  $B_\lambda$ . For the rest of this paper, crystal means an object in this category. A morphism of crystals is a map of the underlying sets that commutes with all the crystal operators. We have the following version of Schur’s Lemma:

**Lemma 4.3.** *Hom( $B_\lambda, B_\mu$ ) contains just the identity if  $\lambda = \mu$  and is empty otherwise. Hence if  $B$  is a crystal there is exactly one way to identify each of its components with a  $B_\lambda$ .  $\square$*

Let  $B$  be a crystal and let  $b \in B$  be a high weight element of weight  $\lambda$ . By lemma 4.3, the component of  $B$  generated by  $b$  is isomorphic to  $B_\lambda$  via a unique isomorphism. So if  $T \in B_\lambda$ , we let  $T(b)$  denote the image of  $b$  under this isomorphism. We refer to  $T(b)$  as the  $T$ -element of the subcrystal generated by  $b$ .

The category  $\mathfrak{gl}_n$ -Crystals acquires a tensor product by the usual tensor product of crystals. The associator in this category is very simple because if  $A, B, C$  are crystals then  $A \otimes (B \otimes C) \rightarrow (A \otimes B) \otimes C$  by  $(a, (b, c)) \mapsto ((a, b), c)$  is an isomorphism of crystals.

**4.2. Commuter for crystals.** The basic idea to construct the commuter is to first produce an involution  $\xi_B : B \rightarrow B$  for each crystal  $B$  that reverses the crystal structure. Then the commuter is defined by  $(a, b) \mapsto \xi(\xi(b), \xi(a))$ . This idea was originally suggested by Arkady Berenstein and is carried out for general  $\mathfrak{g}$  in [HK]. For our case  $\mathfrak{g} = \mathfrak{gl}_n$ , the map  $\xi$  will be the Schützenberger involution on tableaux. We will now define this involution.

First, recall the definition of Gelfand-Tsetlin patterns. A *Gelfand-Tsetlin* pattern of size  $n$  is a map  $T : (i, j) : 1 \leq j \leq i \leq n \rightarrow \mathbb{Z}$  such that  $T(i, j) \geq T(i - 1, j) \geq T(i, j + 1)$ . We will usually draw a GT pattern in a triangle like a hive of size  $n - 1$ , but we use a different indexing convention than for hives to emphasize that GT patterns are less symmetric. We will index them by pairs  $(i, j)$  with  $(0, 0)$  on the top  $(n, 0)$  on the bottom left and  $(n, n)$  on the bottom right.

The *base* of a Gelfand-Tsetlin pattern is the sequence of integers that appear on the bottom row, and the *weight* of a GT pattern is the sequence of difference of row sums from top to bottom.

Recall that there is a bijection between GT patterns of base  $\lambda$  and weight  $\mu$  and tableaux of shape  $\lambda$  and weight  $\mu$ . This bijection sends a tableau  $T$  to the GT pattern whose value at  $(i, j)$  is the number of  $1 \dots i$  on the  $j$ th row of  $T$ .

**Example 4.4.** Here is a tableau and the corresponding GT pattern:

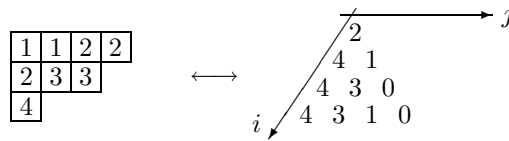

This bijection is so natural that we will use the same letter to denote both the tableau and the corresponding GT pattern, so that if  $T$  is a tableau,  $T(i, j)$  denotes the number of  $1 \dots i$  on row  $j$  of  $T$ .

For each  $1 \leq i < n$ , we have the *Bender-Knuth move*  $s_i$ . This map takes GT patterns of weight  $\lambda$  to themselves by:

$$s_i(T)(k, j) = \begin{cases} \min(T(i + 1, j), T(i - 1, j - 1)) + \\ \max(T(i + 1, j + 1), T(i - 1, j)) - T(i, j) & \text{if } k = i \\ T(k, j) & \text{otherwise} \end{cases}$$

We can now define the *Schützenberger involution* by:

$$\begin{aligned} \xi_\lambda : B_\lambda &\rightarrow B_\lambda \\ T &\mapsto s_1(s_2s_1)\cdots(s_{n-1}\cdots s_1)(T) \end{aligned}$$

**Example 4.5.** Consider:

$$\widehat{P} = \begin{array}{ccccc} & 1 & & 3 & & 3 & & 2 \\ 3 & 1 & \xrightarrow{s_1} & 3 & 1 & \xrightarrow{s_2} & 4 & 1 & \xrightarrow{s_1} & 4 & 1 \\ 4 & 2 & 0 & 4 & 2 & 0 & 4 & 2 & 0 & 4 & 2 & 0 \end{array} \quad \text{so} \quad \xi(\widehat{P}) = \begin{array}{cc} & 2 \\ 4 & 1 \\ 4 & 2 & 0. \end{array}$$

**Proposition 4.6.** *The Schützenberger involution has the following properties with respect to the crystal structure on  $B_\lambda$ :*

$$\begin{aligned} e_i \cdot \xi(T) &= \xi(f_{n-i} \cdot T) \\ f_i \cdot \xi(T) &= \xi(e_{n-i} \cdot T) \\ \text{wt}(\xi(T)) &= w_0 \cdot \text{wt}(T) \end{aligned}$$

where  $w_0$  denotes the long element in the symmetric group.

Extend  $\xi$  to a map  $\xi_B : B \rightarrow B$  for all crystals  $B$  by applying the appropriate  $\xi_\lambda$  to each connected component of  $B$ .

Let  $A, B$  be crystals. We define:

$$(4.1) \quad \begin{aligned} \sigma_{A,B} : A \otimes B &\rightarrow B \otimes A \\ (a, b) &\mapsto \xi_{B \otimes A}(\xi_B(b), \xi_A(a)) \end{aligned}$$

**Theorem 4.2.**  $\sigma_{A,B}$  is a natural isomorphism of crystals.

### 5. Equivalence of Categories

Recall that a tensor functor  $\Phi : \text{Crystals} \rightarrow \text{Hives}$  is a functor  $\Phi$  along with natural isomorphisms

$$\phi_{A,B} : \Phi(A) \otimes \Phi(B) \rightarrow \Phi(A \otimes B)$$

such that the following diagrams commute:

$$(5.1) \quad \begin{array}{ccc} \Phi(A) \otimes (\Phi(B) \otimes \Phi(C)) & \xrightarrow{\alpha} & (\Phi(A) \otimes \Phi(B)) \otimes \Phi(C) \\ \phi \circ 1 \otimes \phi \downarrow & & \phi \circ \phi \otimes 1 \downarrow \\ \Phi(A \otimes (B \otimes C)) & \xrightarrow{\Phi(\alpha)} & \Phi((A \otimes B) \otimes C). \end{array}$$

$$(5.2) \quad \begin{array}{ccc} \Phi(A) \otimes \Phi(B) & \xrightarrow{\sigma} & \Phi(B) \otimes \Phi(A) \\ \phi \downarrow & & \phi \downarrow \\ \Phi(A \otimes B) & \xrightarrow{\Phi(\sigma)} & \Phi(B \otimes A) \end{array}$$

An equivalence of tensor categories is a pair of tensor functors which give rise to an equivalence of categories.

The rest of the paper will be devoted to establishing the following result:

**Theorem 5.1.** *There exists an equivalence of tensor categories between Crystals and Hives.*

We define start by defining functors  $\Phi : \text{Crystals} \rightarrow \text{Hives}$  and  $\Psi : \text{Hives} \rightarrow \text{Crystals}$  by

$$\begin{aligned} \Phi(B)_\lambda &= \{\text{set of highest weight elements of } B \text{ of weight } \lambda\} \\ \Psi(A) &= \bigcup_{\lambda} A_\lambda \times B_\lambda \end{aligned}$$

Clearly these functors provide an equivalence of categories, so it remains to enrich one of them to a tensor functor.

**5.1. From Tableaux to Hives.** Because of the way we have defined  $\Phi$ , it will be very important for us to think about high weight elements of crystals. In particular we must consider the high weight elements of tensor products. Let  $B$  be a crystal. Recall that we have a map  $\varepsilon_i : B \rightarrow \mathbb{Z}$  such that  $\varepsilon_i(b)$  is the number of times we can apply  $e_i$  to  $b$ . We say that  $b \in B$  is  $\mu$ -dominant if  $\varepsilon_i(b) \leq \langle \mu, \alpha_i^\vee \rangle$  for all  $i \in I$ . Examining the definition of tensor product formula we have the following observation which we first found in [St]:

**Lemma 5.1.** *Let  $b \in B$  and  $c \in C$ . Then  $(b, c)$  is high weight iff  $b$  is  $\mu$ -dominant and  $c$  is high weight of weight  $\mu$ .*

A *quasi-hive* is an equivalence class of maps  $P : \Delta_n \rightarrow \mathbb{Z}$  which satisfies the two horizontal rhombus axioms, but not necessarily the vertical rhombus axiom.

Given a quasi-hive, we can produce a GT pattern  $\widehat{P}$  by defining  $\widehat{P}(i, j) = P(i - j, j, n - i) - P(i - j + 1, j - 1, n - i)$ .

**Example 5.2.** For hives  $T, U$  from Example 1.1 we get the GT patterns:

$$\widehat{T} = \begin{array}{cc} & 1 \\ 1 & 1 \\ 2 & 1 & 0 \end{array} \quad \widehat{U} = \begin{array}{cc} & 1 \\ 2 & 1 \\ 2 & 1 & 1 \end{array}$$

which correspond to the tableaux of Example 4.2.

The following bijection was established by Pak and Vallejo [PV2], following similar bijections due to Berenstein and Zelevinsky, and others.

**Theorem 5.2.** *If  $P$  is a quasi-hive, then  $\widehat{P}$  is a GT pattern. Moreover, the map  $P \mapsto \widehat{P}$  provides a bijection between  $\text{HIVE}_{\lambda\mu}^\nu$  and the set of  $\mu$ -dominant tableaux of shape  $\lambda$  and weight  $\nu - \mu$ .*

Now we can define the natural isomorphisms  $\phi_{A,B}$  for  $A, B \in \text{Crystals}$  by:

$$\begin{aligned} \phi_{A,B} : \Phi(A) \otimes \Phi(B) &\rightarrow \Phi(A \otimes B) \\ (a, b, P) &\mapsto (\widehat{P}(a), b) \end{aligned}$$

To see that this makes sense, note that  $a$  is a high weight element of  $A$  of weight  $\lambda$ ,  $b$  is a high weight element of  $B$  of weight  $\mu$  and  $P \in \text{HIVE}_{\lambda\mu}^\nu$ . Then by Lemma 5.1 and Theorem 5.2  $(\widehat{P}(a), b)$  is a high weight element of  $A \otimes B$ . It is of weight  $\nu$  since  $\widehat{P}(a)$  has weight  $\nu - \mu$  and  $b$  has weight  $\mu$ .

**5.2. Associator.** In order to prove that (5.1) commutes we need to better understand what happens to tableaux in tensor products. Let  $X, Y$  be tableaux. One way to perform the Jeu de Taquin process on  $X \star Y$  is to first excavate all the empty boxes to the left of the last row of  $Y$ , then those to the left of the second last row, etc. After excavating the boxes to the left of rows  $n, \dots, k + 1$  of  $Y$ , the resulting skew tableau will be of the form:

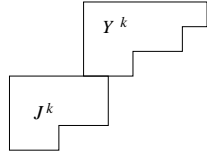

where  $J^k$  is some tableau and  $Y^k$  denotes the first  $k$  rows of  $Y$ . Note that  $J^n = X$  and  $J^0 = J(X \star Y)$ .

**Example 5.3.** If  $\widehat{T}$  and  $\widehat{U}$  are as in Example 4.2, the Jeu de Taquin process produces:

$$\widehat{T} = J_3 = \begin{array}{|c|c|} \hline 1 & 3 \\ \hline 2 & \\ \hline \end{array} \quad J_2 = \begin{array}{|c|c|c|} \hline 1 & 3 & 3 \\ \hline 2 & & \\ \hline \end{array} \quad J_1 = \begin{array}{|c|c|c|} \hline 1 & 2 & 3 \\ \hline 2 & 3 & \\ \hline \end{array} \quad J_0 = \begin{array}{|c|c|c|} \hline 1 & 1 & 2 \\ \hline 2 & 2 & 3 \\ \hline 3 & & \\ \hline \end{array}$$

Now let  $\lambda^k$  denote the shape of  $J^k$ . We define a recording tableau  $R(X, Y)$  for the Jeu de Taquin process. We define it in terms of the associated GT pattern by:

$$R(X, Y)(i, j) = \sum_{r \geq j} \lambda_r^{i-j+1} - \sum_{r \geq j+1} \lambda_r^{i-j}$$

**Example 5.4.** For the above example,

$$\lambda^3 = (2, 1, 0), \lambda^2 = (3, 1, 0), \lambda^1 = (3, 2, 0), \lambda^0 = (3, 3, 1)$$

So as a GT pattern:

$$R(\widehat{T}, \widehat{U}) = \begin{array}{cc} & 1 \\ 2 & 1 \\ 2 & 1 & 0 \end{array}$$

We establish the following refinement of Theorem 4.1:

**Theorem 5.3.** *If  $X \in B_\lambda, Y \in B_\mu$ , then  $(X, Y)$  sits in the component of  $B_\lambda \otimes B_\mu$  with high weight element  $(R(X, Y), b_\mu)$  and represents the  $J(X \star Y)$  element of that crystal.*

Returning to our proof that  $(\Phi, \phi)$  is a tensor functor, we want to prove that the following diagram commutes:

$$\begin{array}{ccc} \Phi(A) \otimes (\Phi(B) \otimes \Phi(C)) & \xrightarrow{\alpha} & (\Phi(A) \otimes \Phi(B)) \otimes \Phi(C) \\ \phi \circ \phi \otimes 1 \downarrow & & \phi \circ 1 \otimes \phi \downarrow \\ \Phi(A \otimes (B \otimes C)) & \xrightarrow{\Phi(\alpha)} & \Phi((A \otimes B) \otimes C) \end{array}$$

Let us carefully examine what we need to prove. Let  $(a, (b, c, U), T) \in (\Phi(A) \otimes (\Phi(B) \otimes \Phi(C)))_\rho$ . Then for some  $\delta$ :

$$a \in \Phi(A)_\lambda, b \in \Phi(B)_\mu, c \in \Phi(C)_\nu, T \in \text{HIVE}_{\lambda\delta}^\rho, U \in \text{HIVE}_{\mu\nu}^\delta$$

Let  $P = P(T, U), Q = Q(T, U)$ . Following the diagram along the top and then down gives  $(\widehat{P}(\widehat{Q}(a), b), c)$ . Following the diagram down and then along the bottom gives  $((\widehat{T}(a), \widehat{U}(b)), c)$ .

Hence we must show that in the tensor product of  $B_\lambda \otimes B_\mu$ ,  $(\widehat{T}, \widehat{U})$  lies in the same component as  $(\widehat{Q}, b_\mu)$  and that it represents the  $\widehat{P}$  element of that crystal. By Theorem 5.3, we see that it suffices to prove the following result which was conjectured by Pak and Vallejo in [PV1]:

**Theorem 5.4.** *We have the following relation between the octahedron recurrence and Jeu de Taquin:*

$$J(\widehat{T} \star \widehat{U}) = \widehat{P} \quad R(\widehat{T}, \widehat{U}) = \widehat{Q}$$

In fact more is true. Each stage of  $J^k$  of the Jeu de Taquin procedure can be read off from the octahedron recurrence:

**Proposition 5.5.** Use  $T, U$  to give a state  $f$  to  $S$  as in section 3.1. Use the octahedron recurrence to extend this state to the region  $A = \{(x, y, t) : |x - y| \leq t \leq n - |n - x - y|\}$ .

Then for each  $k$  define the map

$$(5.3) \quad r^k : \Delta_n \rightarrow A$$

$$(x, y, z) \mapsto \begin{cases} (n - z, x, y) & \text{for } x \leq k \\ (y + k, x, n - k - z) & \text{for } x \geq k \end{cases}$$

Use  $r^k$  to define a quasi-hive  $P^k = f \circ r^k$ .

Then  $\widehat{P}^k = J^k(\widehat{T}, \widehat{U})$ .

**Example 5.6.** Choosing hives  $T, U$  from Example 1.1, produces the state in Example 3.1. Reading off the  $P^k$  from this state gives:

$$P^3 = T = \begin{array}{cccc} & 0 & & \\ & 2 & 3 & \\ 4 & 5 & 6 & \\ 5 & 7 & 8 & 8 \end{array} \quad P^2 = \begin{array}{cccc} & 0 & & \\ & 2 & 3 & \\ 4 & 5 & 6 & \\ 4 & 7 & 8 & 8 \end{array} \quad P^1 = \begin{array}{cccc} & 0 & & \\ & 2 & 3 & \\ 3 & 5 & 6 & \\ 3 & 6 & 8 & 8 \end{array} \quad P^0 = P = \begin{array}{cccc} & 0 & & \\ & 1 & 3 & \\ 1 & 4 & 6 & \\ 1 & 4 & 7 & 8 \end{array}$$

These hives  $T, U$  correspond to the tableaux  $\widehat{T}, \widehat{U}$  from Example 4.2. Applying Jeu de Taquin to this pair of tableaux produced the intermediate tableaux  $J^k$  in Example 5.3. Note that the hives  $P^k$  correspond to these tableaux  $J^k$  and that the hive  $Q$  from Example 3.1 corresponds to the recording tableau  $R(\widehat{T}, \widehat{U})$  from Example 5.4.

**5.3. Commuter.** To prove that the commuter diagram commutes we begin with the following consideration. Let  $P \in \text{HIVE}'_{\lambda\mu}$ . By Lemma 5.1 and Theorem 5.2,  $(\widehat{P}, b_\mu)$  is a high weight element of  $B_\lambda \otimes B_\mu$ .  $P$  can also be turned into a tableau  $\widetilde{P}$  of shape  $\mu$  by the formula:

$$(5.4) \quad \widetilde{P}(i, j) = P(j, n - i, i - j) - P(j - 1, n - i, i - j + 1)$$

**Example 5.7.** If  $P$  is as in Example 3.3, then as GT pattern:

$$\widetilde{P} = \begin{array}{cc} & 1 \\ 3 & 1 \\ 4 & 2 & 0 \end{array}$$

Note that each crystal  $B_\lambda$  possesses a *lowest weight element*, that is a  $c_\lambda \in B_\lambda$  that is killed by all  $f_i$  and such that  $B_\lambda$  is generated by  $e_i$  acting on  $c_\lambda$ . In terms of tableaux,  $c_\lambda$  is the tableau with  $n$  at the end of every row,  $n - 1$  second from the end of every row, etc. Also note that  $\xi(b_\lambda) = c_\lambda$ .

Recall that for  $P \in \text{HIVE}'_{\lambda\mu}$ ,  $(\widehat{P}, b_\mu)$  was a highest weight element of the crystal  $B_\lambda \otimes B_\mu$ . We have the following related result for  $\widetilde{P}$ :

**Lemma 5.8.**  $(c_\lambda, \widetilde{P})$  is the lowest weight element of connected component of  $B_\lambda \otimes B_\mu$  with highest weight  $(\widehat{P}, b_\mu)$ .

Returning to the commuter diagram, we need to prove that the following commutes:

$$\begin{array}{ccc} \Phi(A) \otimes \Phi(B) & \xrightarrow{\sigma} & \Phi(B) \otimes \Phi(A) \\ \phi \downarrow & & \phi \downarrow \\ \Phi(A \otimes B) & \xrightarrow{\Phi(\sigma)} & \Phi(B \otimes A) \end{array}$$

Let  $(a, b, P) \in (\Phi(A) \otimes \Phi(B))_\nu$ , where:

$$a \in \Phi(A)_\lambda, \quad b \in \Phi(B)_\mu, \quad P \in \text{HIVE}'_{\lambda\mu}$$





**Acknowledgements.** We would like to thank Arkady Berenstein, Cilanne Boulet, Mark Haiman, Allen Knutson, Igor Pak, David Speyer, and Dylan Thurston for helpful conversations.

### References

- [HK] A. Henriques and J. Kamnitzer, *Crystals and bubbled categories*, In preparation.
- [KTW] A. Knutson, T. Tao and C. Woodward, *A positive proof of the Littlewood-Richardson rule using the octahedron recurrence*, arXiv:math.CO/0306274.
- [PV1] I. Pak and E. Vallejo, *Reductions of Young tableau bijections*, In preparation.
- [PV2] I. Pak and E. Vallejo, *Combinatorics and geometry of Littlewood-Richardson cones*, Preprint available at: <http://www-math.mit.edu/~pak/research.html>.
- [RR] D.P. Robbins and H. Rumsey, *Determinants and alternating-sign matrices*, Adv. Math. **62** (1986), 169–184.
- [Sh] M. Shimozono, *Affine type A crystal structure on tensor products of rectangles, Demazure characters, and nilpotent varieties*, J. Algebraic Combin. **15** (2002), no. 2, 151–187.
- [St] J. Stembridge, *Combinatorial models for Weyl characters*, Adv. Math. **168** (2002), no. 1, 96–131.

DEPARTMENT OF MATHEMATICS, MIT, CAMBRIDGE, MA, USA

*E-mail address:* andrhenr@math.mit.edu

DEPARTMENT OF MATHEMATICS, UC BERKELEY, BERKELEY, CA, USA

*E-mail address:* jkamnitz@math.berkeley.edu



## A Signed Analog of the Birkhoff Transform

Samuel K. Hsiao

**Abstract.** We construct a family of posets, called signed Birkhoff posets, that may be viewed as signed analogs of distributive lattices. Our posets are generally not lattices, but they are shown to possess many combinatorial properties corresponding to well known properties of distributive lattices. They have the additional virtue of being face posets of regular cell decompositions of spheres. We give a combinatorial description the **cd**-index of a signed Birkhoff poset in terms of peak sets of linear extensions of an associated labeled poset. Our description is closely related to a result of Billera, Ehrenborg, and Readdy's expressing the **cd**-index of an oriented matroid in terms of the flag  $f$ -vector of the underlying geometric lattice. As an analog of the Distributive Lattice Conjecture, we conjecture that the chain polynomial of a signed Birkhoff poset has only real zeros.

### 1. Introduction

This paper introduces a signed analog of the standard construction of a distributive lattice  $J(P)$  from a finite poset  $P$ . Beginning with the work of Birkhoff [Bi], distributive lattices have been well studied from a combinatorial viewpoint. Nowadays they are often analyzed in conjunction with notions such as  $P$ -partitions, linear extensions, and  $R$ -labelings; see, e.g., [Sta4, Chapter 3]. Our construction will give rise to a family of Eulerian posets that are amenable to similar types of analyses. Stembridge's enriched  $P$ -partitions [Ste] turn out to play a role in the enumeration theory of these posets that is analogous to the role of Stanley's  $P$ -partitions [Sta1] for distributive lattices. Our enumerative analysis is motivated by the work of Billera, Ehrenborg, and Readdy on the **cd**-index of oriented matroids [BER]. Although the posets that we construct are not directly related to face lattices of oriented matroids, the flag vectors of these two classes of posets are seen to have some remarkably similar properties.

Given a positive integer  $n$  and a poset  $P$  on the set  $[n] := \{1, 2, \dots, n\}$  partially ordered by  $\leq_P$ , let  $\pm P$  be the poset on  $\{\pm 1, \dots, \pm n\}$  ordered so that  $p <_{\pm P} q$  if and only if  $|p| <_P |q|$ . A *filter* of a poset  $Q$  is a subset  $X$  of  $Q$  such that whenever  $q \in X$  and  $q <_Q q'$  then  $q' \in X$ . The *Birkhoff transform* of  $P$  is the poset (distributive lattice)  $J(P)$  consisting of the filters of  $P$  ordered by reverse inclusion.<sup>1</sup> Define a *signed  $P$ -filter* to be a filter  $X$  of  $\pm P$  such that if  $p$  is a minimal element of  $X$  then  $-p \notin X$ . We now define the main object of study.

---

2000 *Mathematics Subject Classification.* Primary 06A07, 06A11, 05A15; Secondary 06D05.

*Key words and phrases.* Distributive lattice, Eulerian poset, flag  $f$ -vector, **cd**-index, enriched  $P$ -partition, quasisymmetric function, peak algebra, Neggers-Stanley Poset Conjecture.

A portion of the results presented here first appeared in the author's doctoral thesis, written under the supervision of Louis Billera. This research is partially supported by the NSF Postdoctoral Research Fellowship.

<sup>1</sup>Usually  $J(P)$  is defined as the poset of order ideals of  $P$  under inclusion, rather than as the filters under reverse inclusion; these two definitions yield isomorphic posets. Filters turn out to be more convenient for us notationally.

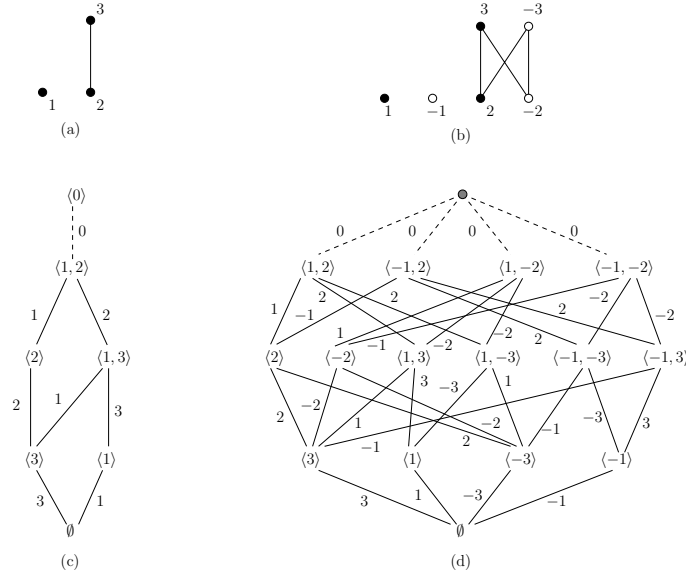

FIGURE 1. (a) A naturally labeled poset  $P$ ; (b) the induced labeled poset  $\pm P$ ; (c) the dual Birkhoff transforms  $J(P)^*$  (without top element) and  $J(P_0)^*$  (with top element), with edge-labeling induced by  $P$ ; (d) the signed Birkhoff transform  $B(P)$  (without top element) and  $\widehat{B}(P)$  (with top element), with edge-labeling induced by  $P$ .

**Definition 1.1.** The *signed Birkhoff transform* of  $P$  is the poset  $B(P)$  consisting of all signed  $P$ -filters ordered by inclusion.

Note that one could define the signed Birkhoff transform more abstractly without identifying  $P$  with  $[n]$ . This identification is made here for notational convenience and without loss of generality. Let  $\widehat{B}(P)$  denote the poset  $B(P)$  with a unique maximal element  $\hat{1}$  added. Any poset of the form  $B(P)$  or  $\widehat{B}(P)$  is called a *signed Birkhoff poset*.<sup>2</sup> For clarity we sometimes call  $\widehat{B}(P)$  a *graded signed Birkhoff poset* (cf. Proposition 2.2).

Figure 1 illustrates both the ordinary and signed Birkhoff transforms of a three element poset. Filters in the figure are denoted by  $\langle p_1, \dots, p_m \rangle$ , where  $p_1, \dots, p_m$  are the minimal generators of the filter. Let us also point out two interesting families of examples. First recall that the *face poset*  $P(\Gamma)$  of a finite regular cell complex  $\Gamma$  is the poset of cells of  $\Gamma$ , along with the empty cell, ordered by inclusion of their closures.

**Example 1.2.** If  $P$  is an  $n$ -element chain, then  $B(P)$  is isomorphic to the face poset of a regular cell decomposition of the  $(n - 1)$ -sphere with exactly two cells in each dimension. Such a poset is sometimes called a ladder.

**Example 1.3.** If  $P$  is an  $n$ -element antichain, then  $B(P)$  is isomorphic to the face poset of the boundary of an  $n$ -dimensional hyperoctahedron.

Our main results are summarized below.

In Section 2 we discuss basic structural properties of signed Birkhoff posets, the highlight being a “pairing procedure” (Theorem 2.5) that allows one to recover  $P$  uniquely (up to isomorphism) from  $B(P)$ . This is analogous in part to Birkhoff’s fundamental theorem for finite distributive lattices, which asserts that every

<sup>2</sup>To our knowledge, there is no direct connection between signed Birkhoff posets and the hyperoctahedral analogs of posets, called signed posets, introduced by Reiner [R].

finite distributive lattice  $L$  is isomorphic to the poset of order ideals of the subposet of join irreducibles of  $L$ . Presently lacking in this analogy is an intrinsic characterization of signed Birkhoff posets that avoids reference to an underlying poset  $P$ . Interestingly,  $\widehat{B}(P)$  is *not* a lattice unless  $P$  is an antichain (Proposition 2.1), so the pairing procedure does not involve lattice notions such as join irreducibility.

Section 3 deals with shellability properties of signed Birkhoff posets. We show that the edge-labeling of  $\widehat{B}(P)$  induced by a natural labeling of  $P$  is an  $EL$ -labeling and a dual  $R$ -labeling (Theorem 3.1). This implies that  $\widehat{B}(P)$  is Gorenstein\* for every  $P$ . The Gorenstein\* property is also a consequence of the fact that  $B(P)$  is the face poset of a regular shellable decomposition of a sphere (Theorem 3.4). This result, first established by Billera and the author, is proved here by showing that  $\widehat{B}(P)$  admits a recursive coatom ordering (Theorem 3.3) then invoking a theorem of Björner's on cellular interpretations of posets [Bj2].

Section 4 covers enumerative aspects of signed Birkhoff posets. Let  $P_0$  denote the poset  $P$  with a unique minimal element added. We establish the identity (Theorem 4.1)

$$(1.1) \quad 2F_{\widehat{B}(P)^*} = \widetilde{K}_{P_0}$$

relating Ehrenborg's  $F$ -quasisymmetric function (which encodes the flag  $f$ -vector) of the dual poset  $\widehat{B}(P)^*$  to the weight enumerator for enriched  $P_0$ -partitions. This fundamental identity follows easily from Stembridge's original work on enriched  $P$ -partitions [Ste] as well as from Bergeron, Mykytiuk, Sottile, and van Willigenburg's theory of Eulerian Pieri operators [BMSW, Section 7]. The latter work is relevant because of the close connection between the signed Birkhoff transform and the doubled réseau of a distributive lattice. A corollary of (1.1) is a description of the zeta polynomial of  $\widehat{B}(P)$  in terms of the enriched order polynomial of  $P_0$ . Using recent work of Billera, Hsiao, and van Willigenburg [BHW] connecting the  $\mathbf{cd}$ -index to Stembridge's peak algebra, we derive from (1.1) a combinatorial interpretation of the  $\mathbf{cd}$ -index of  $\widehat{B}(P)$  in terms of peak sets of linear extensions of  $P_0$  (Theorem 4.4). Our description implies that the  $\mathbf{cd}$ -index of  $\widehat{B}(P)$  is coefficient-wise maximized when  $P$  is an antichain and minimized when  $P$  is a chain. There is an elegant reformulation of (1.1) that directly relates the  $\mathbf{cd}$ -index of a signed Birkhoff poset to the flag  $f$ -vector of its underlying distributive lattice (Theorem 4.12). Our formula is essentially identical to the expression provided by Billera, Ehrenborg, and Readdy [BER] relating the  $\mathbf{cd}$ -index of an oriented matroid to the flag  $f$ -vector of its geometric lattice of flats (Theorem 4.11).

In Section 5 we conjecture that the chain polynomial of  $\widehat{B}(P)$  has only real zeros. This is a signed analog of the Distributive Lattice Conjecture, which is equivalent to the Neggers-Stanley Poset Conjecture for naturally labeled posets [Br1]. We show that ours is equivalent to Stembridge's Enriched Poset Conjecture for naturally labeled posets having a unique minimal element.

All posets in this paper are assumed to be finite unless otherwise indicated. A graded poset is always assumed to have a unique minimal element  $\hat{0}$  and a unique maximal element  $\hat{1}$ . Unexplained terminology and further background related to posets can be found in [Sta4, Chapter 3].

**Acknowledgments.** We are grateful to Louis Billera and Marcelo Aguiar for many valuable discussions. We also thank two anonymous referees for helpful comments.

## 2. Signed Birkhoff posets

Assume throughout this section that  $n > 0$  is fixed and  $P$  is a poset on  $[n]$  ordered by  $\leq_P$ . Sometimes  $P$  is called a *labeled poset*. Say that  $P$  is *naturally labeled* if  $p <_P q$  implies  $p < q$  as integers. Let  $P_0$  denote the labeled poset obtained from  $P$  by adding a unique minimal element labeled 0.

**2.1. Basic properties.** Some familiar properties of ordinary Birkhoff transforms carry over to signed transforms without much difficulty. For instance, as with the identity  $J(P \sqcup Q) \cong J(P) \times J(Q)$ , it is straightforward to show that

$$(2.1) \quad B(P \sqcup Q) \cong B(P) \times B(Q),$$

where  $\sqcup$  and  $\times$  denote, respectively, the disjoint union and cartesian product operations for posets.

Unlike the class of distributive lattices, the class of signed Birkhoff posets is not closed under taking intervals. For instance, the poset in Figure 1(d) has several intervals that are isomorphic to the Boolean lattice of rank 3, which itself is not a signed Birkhoff poset. The following result points to another significant difference between these two classes of posets.

**Proposition 2.1.**  $\widehat{B}(P)$  is a lattice if and only if  $P$  is an antichain.

In the sequel it will be useful to relate ordinary and signed transforms via the order-reversing surjective map  $\varphi : \widehat{B}(P) \rightarrow J(P_0)$  defined by

$$\varphi(X) = \begin{cases} \{|p| : p \in X\} & \text{if } X \in B(P), \\ P_0 & \text{if } X = \hat{1}. \end{cases}$$

Note that  $\varphi$  restricts to a map from  $B(P)$  onto  $J(P)$ .

The cover relations in  $J(P)$  are precisely those relations of the form  $A \cup \{p\} < A$  for some maximal element  $p$  of  $P \setminus A$ . Thus  $J(P)$  is graded of rank  $n$  with rank function given by  $rk(A) = n - \#A$ . The corresponding assertions for signed Birkhoff posets follow easily:

**Proposition 2.2.** The cover relations in  $B(P)$  are precisely those relations of the form  $X < X \cup \langle p \rangle$  such that  $p$  and  $-p$  are maximal elements of  $\pm P \setminus X$  or, equivalently,  $|p|$  is a maximal element of  $P \setminus \varphi(X)$ . Thus  $\widehat{B}(P)$  is a graded poset of rank  $n + 1$  with rank function given by  $rk(X) = \#\varphi(X)$ .

It is a basic property of the Birkhoff transform that a sequence  $(p_1, \dots, p_n) \in P^{\times n}$  is in  $\mathcal{L}(P)$ , the set of linear extensions of  $P$ , if and only if  $\{p_1, \dots, p_n\} < \{p_2, \dots, p_n\} < \dots < \{p_n\} < \emptyset$  is a maximal chain of  $J(P)$ . By Proposition 2.2, if  $c = \{\emptyset = X_0 < X_1 < \dots < X_n\}$  is a maximal chain of  $B(P)$  then there exists a sequence  $\lambda(c) = (p_1, \dots, p_n) \in (\pm P)^{\times n}$  such that  $X_i = X_{i-1} \cup \langle p_i \rangle$  for all  $i$ . Such sequences can be characterized as “signed linear extensions” of  $P$ :

**Proposition 2.3.** Let  $\pi \in (\pm P)^{\times n}$ . Then  $\pi = \lambda(c)$  for some (unique) maximal chain  $c$  of  $B(P)$  if and only if  $\pi = \varepsilon\sigma$  for some  $(\varepsilon, \sigma) \in \{\pm 1\}^{\times n} \times \mathcal{L}(P)$ .

**Remark 2.4.** The doubled réseau  $\delta J(P)$  studied by Bergeron, et al. in [BMSW] is the directed graph obtained by replacing each labeled edge  $A \cup \{p\} \xrightarrow{p} A$  in the Hasse diagram of  $J(P)$  with the two labeled edges  $A \cup \{p\} \xrightarrow{p} A$  and  $A \cup \{p\} \xrightarrow{-p} A$ . In light of Proposition 2.3, we may view signed Birkhoff posets as “poset realizations” of doubled réseaux of distributive lattices. It is then possible to infer a direct connection between flag enumeration in  $\widehat{B}(P)$  and weight enumeration of enriched  $P$ -partitions via the theory of Eulerian Pieri operators developed in [BMSW, Section 7]; see Theorem 4.1 and Remark 4.2.

**2.2. The pairing procedure.** Let  $B = B(P)$ . We describe a procedure for recovering  $P$  from  $B$ . Define an equivalence relation on  $B$  by putting  $X \equiv X'$  if and only if  $X$  and  $X'$  cover exactly the same set of elements, so in particular  $X$  and  $X'$  are of the same rank. Let  $T_1, \dots, T_m$  be the non-singleton equivalence classes in  $B/\equiv$ , indexed so that  $i < j$  whenever the elements of  $T_i$  have rank greater than those of  $T_j$ . Our goal is to inductively construct posets  $B_1, \dots, B_m$  whose isomorphism types depend only on the isomorphism type of  $B$ ; the result is that  $B_m \cong P^*$ .

It is easy to see that  $\langle p \rangle \equiv \langle -p \rangle$  for all  $p \in P$  and that every  $T_i$  is the union of sets of the form  $\{\langle p \rangle, \langle -p \rangle\}$ . Fix a partition of  $T_1$  into blocks of size two and let  $B_1$  be the antichain consisting of these blocks. Assume by induction that the poset  $B_{i-1}$  has been constructed for some  $i > 1$ . Given  $X, X' \in T_i$ , write  $X \equiv_i X'$  provided that for every  $j < i$  and  $Y \in T_j$  we have  $X < Y$  if and only if  $X' < Y$ . Each equivalence class in  $T_i/\equiv_i$  has even size because  $\langle p \rangle \equiv_i \langle -p \rangle$  for any  $p$ . Now partition each equivalence class in  $T_i/\equiv_i$  arbitrarily into blocks of size two. Define the poset  $B_i$  by adjoining these two-element blocks to  $B_{i-1}$  and, for any such block  $\{X, X'\}$  and any  $\{Y, Y'\} \in B_{i-1}$ , putting  $\{X, X'\} <_{B_i} \{Y, Y'\}$  if and only if  $X$  and  $X'$  are both less than  $Y$  and  $Y'$ .

**Theorem 2.5.** *The pairing procedure, when applied to  $B(P)$ , always produces a poset that is isomorphic to  $P^*$ . Thus  $P$  is uniquely determined by  $B(P)$  (up to isomorphism).*

**Example 2.6.** Let  $B = B(P)$  be the poset from Figure 1(d). Then the pairing procedure yields the following:

1.  $T_1 = \{\langle 2 \rangle, \langle -2 \rangle\}$ ;
2.  $T_2 = \{\langle 1 \rangle, \langle -1 \rangle, \langle 3 \rangle, \langle -3 \rangle\}$ ;
3.  $B_1$  is the one-element antichain  $\{\{\langle 2 \rangle, \langle -2 \rangle\}\}$ ;
4.  $T_2 / \equiv_2 = \{\{\langle 1 \rangle, \langle -1 \rangle\}, \{\langle 3 \rangle, \langle -3 \rangle\}\}$ ;
5.  $B_2$  is the poset on the set  $\{\langle 2 \rangle, \langle -2 \rangle\}, \{\langle 1 \rangle, \langle -1 \rangle\}, \{\langle 3 \rangle, \langle -3 \rangle\}$  with exactly one relation,  $\{\langle 3 \rangle, \langle -3 \rangle\} <_{B_2} \{\langle 2 \rangle, \langle -2 \rangle\}$ .

Note that  $B_2$  is isomorphic to  $P^*$  via the map  $\{\langle p \rangle, \langle -p \rangle\} \mapsto |p|$ .

### 3. Shellability and sphericity

Assume throughout this section that  $n > 0$  is fixed and  $P$  is a poset on  $[n]$ .

**3.1. EL-shellability.** An *edge-labeling* of a poset is a map from its cover relations to the integers. The edge-labeling of  $J(P)$  induced by  $P$  is defined by mapping each cover relation  $A \cup \{p\} < A$  to  $p$ . Similarly, the edge-labeling of  $B(P)$  induced by  $P$  is defined by mapping the cover relation  $X < X \cup \langle p \rangle$  to  $p$ . We extend this to an edge-labeling of  $\widehat{B}(P)$  by mapping each cover relation of the form  $X < \hat{1}$  to 0. Figure 1 illustrates induced edge-labelings.

Let  $\lambda$  be an edge-labeling of a graded poset  $Q$ . Given a maximal chain  $c = \{q_0 < q_1 < \dots < q_m\}$  of some interval  $[q_0, q_m]$  of  $Q$ , say that  $c$  is *increasing* if its label-sequence  $\lambda(c) := (\lambda(q_0, q_1), \dots, \lambda(q_{m-1}, q_m))$  is a weakly increasing sequence, and say that  $c$  is *decreasing* if  $\lambda(c)$  is a strictly decreasing sequence. Call  $\lambda$  an *R-labeling* if every interval  $I$  has a unique increasing chain, which we denote by  $a_I$ . Call  $\lambda$  an *EL-labeling* if it is an *R-labeling* and for every interval  $I$ ,  $\lambda(a_I)$  is lexicographically smaller than  $\lambda(c)$  for any other maximal chain  $c$  of  $I$ . Call  $\lambda$  a *dual R-labeling* if it is an *R-labeling* of the dual poset  $Q^*$ . If  $Q$  has an *EL-labeling*, then the lexicographic ordering of its maximal chains determines a *shelling* of the order complex of  $Q$  [Bj1]. For this reason we call such a poset *EL-shellable*. If  $P$  is naturally labeled, then the induced edge-labeling of  $J(P)$  is well-known (and easily shown) to be an *EL-labeling*.

**Theorem 3.1.** *If  $P$  is naturally labeled then the induced edge-labeling of  $\widehat{B}(P)$  is both an EL-labeling and a dual R-labeling.*

A graded poset  $Q$  with rank function  $rk$  is called *Eulerian* if its Möbius function satisfies  $\mu_Q(p, q) = (-1)^{rk(q) - rk(p)}$  for every  $p \leq_Q q$ . It is called *Cohen-Macaulay* (over the rationals) if the homology of the order complex (i.e. simplicial complex of chains) of every open interval in  $Q$  vanishes below the top dimension. Say that  $Q$  is *Gorenstein\** if it is Eulerian and Cohen-Macaulay.

**Corollary 3.2.**  $\widehat{B}(P)$  is *Gorenstein\**.

**3.2. Recursive coatom ordering. Sphericity.** Let  $Q$  be a graded poset. A *coatom* of  $Q$  is an element covered by  $\hat{1}$ . Let  $coat(Q)$  denote the set of coatoms of  $Q$ . Following [BW], we say that  $Q$  *admits a recursive coatom ordering* if its rank is 1, or if its rank is greater than 1 and there is an ordering  $x_1, x_2, \dots, x_m$  of its coatoms such that the following conditions hold:

(i) For all  $j = 1, \dots, m$ ,  $[\hat{0}, x_j]$  admits a recursive coatom ordering in which the elements in  $coat([\hat{0}, x_j]) \cap (\cup_{i < j} coat([\hat{0}, x_i]))$  come first.

(ii) For all  $i < j$ , if  $y < x_i, x_j$  then there exist  $k < j$  and  $z \in \widehat{B}(P)$  such that  $y \leq z < x_k, x_j$ .

**Theorem 3.3.**  $\widehat{B}(P)$  admits a recursive coatom ordering.

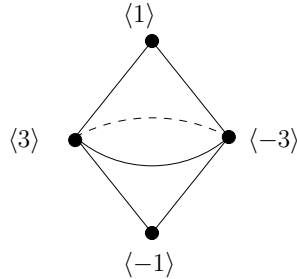

FIGURE 2. A cell decomposition of the 2-sphere into four 0-cells, six 1-cells, and four 2-cells. The face poset of this sphere is the signed Birkhoff poset in Figure 1(d).

The recursive coatom ordering property is a purely combinatorial formulation of the concept of shellability for a regular cell complex. It also generalizes the notion of *EL*-shellability. For a graded poset  $Q$ ,

$$Q \text{ is } EL\text{-shellable} \implies Q^* \text{ admits a recursive coatom ordering.}$$

These shelling properties make it possible to interpret intervals in signed Birkhoff posets (and their duals) as regular decompositions of spheres. Given a finite regular cell complex  $\Gamma$ , let  $\widehat{P}(\Gamma)$  denote the face poset  $P(\Gamma)$  with a unique maximal element added. Call a graded poset *thin* if every interval of rank 2 has size 4. Björner [Bj2] showed that a graded poset  $Q$  of rank  $n$  is isomorphic to  $\widehat{P}(\Gamma)$  for  $\Gamma$  a shellable regular cell decomposition of the  $(n - 2)$ -sphere if and only if  $Q$  is thin and admits a recursive coatom ordering. It is easy to prove directly that graded signed Birkhoff posets are thin. (This also follows from the fact that they are Eulerian.) Thus Björner’s theorem together with Theorem 3.1 and Theorem 3.3 yield the following:

**Theorem 3.4** (Billera and Hsiao). *Let  $[X, Y]$  be an interval in  $\widehat{B}(P)$  or  $\widehat{B}(P)^*$ . Then  $[X, Y]$  is isomorphic to the face poset of a shellable regular decomposition of the  $(rk(Y) - rk(X) - 2)$ -sphere.*

Figure 2 illustrates a cell complex whose face poset is the signed Birkhoff poset from Figure 1(d).

**Remark 3.5.** A different proof that  $B(P)$  is the face poset of a regular sphere was originally found by Billera and the author via an explicit geometric description of the cell decomposition. The geometric aspects of signed Birkhoff posets will be studied in greater detail elsewhere. We thank Sergey Fomin for pointing us to Björner’s result.

### 4. Enumerative properties

**4.1. Quasisymmetric generating functions.** Let  $\mathcal{Q} = \bigoplus_{n \geq 0} \mathcal{Q}^n$  denote the *graded algebra of quasisymmetric functions* over  $\mathbb{Q}$  in the variables  $x_1, x_2, \dots$ . The vector space  $\mathcal{Q}^n$  consists of those homogeneous power series in  $\mathbb{Q}[[x_1, x_2, \dots]]$  of degree  $n$  for which the coefficients of  $x_1^{a_1} x_2^{a_2} \cdots x_k^{a_k}$  and  $x_{i_1}^{a_1} x_{i_2}^{a_2} \cdots x_{i_k}^{a_k}$  are equal whenever  $i_1 < \cdots < i_k$  and  $a_1, \dots, a_k$  is a sequence of positive integers summing to  $n$ . Set  $\mathcal{Q}^0 = \mathbb{Q}$ . For each  $n \geq 1$ , the *fundamental basis* for  $\mathcal{Q}^n$  is the linear basis consisting of the  $2^{n-1}$  elements

$$L_S := \sum_{\substack{i_1 \leq \dots \leq i_n: \\ j \in S \implies i_j < i_{j+1}}} x_{i_1} x_{i_2} \cdots x_{i_n} \quad (S \subseteq [n - 1]).$$

This notation suppresses the dependence of  $L_S$  on  $n$ . See [Sta5] for general background and references on quasisymmetric functions.

Let  $Q$  be a graded poset (with  $\hat{0}$  and  $\hat{1}$ ) of rank  $n$  with rank function  $rk$ . If  $s \leq t \in Q$  then write  $rk(s, t) = rk(t) - rk(s)$ . To study the flag enumerative invariants of  $Q$ , it will be useful to work with the



following quasisymmetric generating function introduced by Ehrenborg [E1]:

$$F_Q := \sum_{\substack{k \geq 1, \\ \hat{0} = t_0 \leq t_1 \leq \dots \leq t_{k-1} < t_k = \hat{1}}} x_1^{rk(t_0, t_1)} x_2^{rk(t_1, t_2)} \dots x_k^{rk(t_{k-1}, t_k)},$$

where the sum is over all multichains of  $Q$  from  $\hat{0}$  to  $\hat{1}$  in which  $\hat{1}$  occurs exactly once. We review some essential facts about this generating function.

Recall that the *descent set* of a sequence  $\sigma = (\sigma_1, \sigma_2, \dots, \sigma_n)$  of integers is defined by  $Des(\sigma) := \{i \in [n - 1] : \sigma_i > \sigma_{i+1}\}$ . If  $Q$  has an  $R$ -labeling  $\lambda$ , then

$$(4.1) \quad F_Q = \sum_c L_{Des(\lambda(c))},$$

where the sum is over all maximal chains  $c$  of  $Q$ . In general, when  $Q$  does not necessarily have an  $R$ -labeling, the vector of coefficients of  $F_Q$  in the fundamental basis is the *flag  $h$ -vector* of  $Q$ .

Given a poset  $P$ , let  $\mathcal{A}(P)$  denote the set of  $P$ -partitions; i.e. order-preserving maps from  $P$  to the positive integers.<sup>3</sup> The *weight enumerator* for  $P$ -partitions is the quasisymmetric function

$$K_P := \sum_{\sigma \in \mathcal{A}(P)} x_{\sigma(1)} x_{\sigma(2)} \dots x_{\sigma(n)}.$$

Gessel [G] first studied quasisymmetric weight enumerators for more general objects called  $(P, \omega)$ -partitions [Sta1], the motivation being that these weight enumerators generalize Schur functions in a combinatorially useful way. It is easy to verify using (4.1) (see [Sta5, page 359]) that

$$(4.2) \quad F_{J(P)} = K_P.$$

Theorem 4.1 below expresses a similar relationship between  $F_{\hat{B}(P)^*}$  and Stembridge’s enriched weight enumerator.

**4.2. Enumeration in the peak algebra.** The *peak set* of a sequence  $\sigma = (\sigma_1, \dots, \sigma_n)$  of integers is defined to be

$$Peak(\sigma) := \{i \in \{2, 3, \dots, n - 1\} : \sigma_{i-1} < \sigma_i > \sigma_{i+1}\}.$$

Let  $Peak_n$  denote the set of all possible peak sets of sequences of length  $n$ . Thus,  $S \in Peak_n$  if and only if (i)  $1, n \notin S$  and (ii)  $i \in S$  implies  $i - 1 \notin S$ . For each  $S \in Peak_n$ , the *peak function*  $\theta_S \in \mathcal{Q}^n$  is defined by

$$\theta_S := 2^{\#S+1} \sum_{T \subseteq [n-1]: S \subseteq T \Delta (T+1)} L_T,$$

where  $T \Delta U := (T \setminus U) \cup (U \setminus T)$  and  $T + 1 := \{i + 1 : i \in T\}$ . The peak functions are linearly independent and span a proper subalgebra  $\Pi$  of  $\mathcal{Q}$ , called the *peak algebra* [Ste].

Let  $\pm\mathcal{P}$  be the linear order  $-1 < +1 < -2 < +2 < -3 < +3 < \dots$  on the set of non-zero integers. An *enriched  $P$ -partition* of a poset  $P$  is an order-preserving map  $\sigma : P \rightarrow \pm\mathcal{P}$  such that if  $\sigma(p) = \sigma(q)$  then  $\sigma(p) > 0$ . Let  $\mathcal{E}(P)$  denote the set of enriched  $P$ -partitions. The *enriched weight enumerator* for  $P$ -partitions is the quasisymmetric function

$$\tilde{K}_P := \sum_{\sigma \in \mathcal{E}(P)} x_{|\sigma(1)|} x_{|\sigma(2)|} \dots x_{|\sigma(n)|}.$$

---

<sup>3</sup>What we call a  $P$ -partition here is what Stanley [Sta1] originally calls a reverse  $P$ -partition.

Stembridge [Ste] originally defined enriched weight enumerators in the more general context of enriched  $(P, \omega)$ -partitions.<sup>4</sup> His theory of enriched  $(P, \omega)$ -partitions was motivated by the study of Schur’s  $Q$ -functions. A basic property of enriched weight enumerators is that

$$(4.3) \quad \tilde{K}_P = \sum_{\sigma \in \mathcal{L}(P)} \theta_{Peak(\sigma)}$$

when  $P$  is naturally labeled.

**Theorem 4.1.** *For any poset  $P$ ,*

$$2F_{\widehat{B}(P)^*} = \tilde{K}_{P_0}.$$

PROOF. We may assume without loss of generality that  $P$  is a naturally labeled poset on  $[n]$ . It follows from [Ste, Theorem 3.6 and (1.4)] that

$$(4.4) \quad \begin{aligned} \tilde{K}_{P_0} &= \sum_{(\varepsilon, \sigma) \in \{\pm 1\}^{\times(n+1)} \times \mathcal{L}(P_0)} L_{Des(\varepsilon\sigma)} \\ &= 2 \sum_{(\varepsilon, \sigma) \in \{\pm 1\}^{\times n} \times \mathcal{L}(P)} L_{Des(0, \varepsilon\sigma)}. \end{aligned}$$

The last expression equals  $2F_{\widehat{B}(P)^*}$  by Proposition 2.3 and the fact that, by Theorem 3.1, the induced edge-labeling of  $\widehat{B}(P)^*$  is an  $R$ -labeling. □

**Remark 4.2.** In [BMSW, Example 7.5] it is observed that  $\tilde{K}_{P_0} = \sum_c L_{Des(c)}$ , the sum being over all maximal chains in the doubled reséau  $\delta J(P_0)$ . This formula is essentially (4.4) and thus provides an alternate approach to proving Theorem 4.1. Yet another proof can be adapted from that of [BER, Theorem 3.1]; see Remark 4.13.

The *enriched order polynomial*  $\Omega'(P, m)$  is the number of enriched  $P$ -partitions  $\sigma : P \rightarrow \pm \mathcal{P}$  such that  $\sigma(p) \preccurlyeq m$  for all  $p \in P$ . As an enriched analog of the familiar equation  $Z(J(P), m) = \Omega(P, m)$  relating the zeta polynomial of  $J(P)$  to the order polynomial of  $P$  [Sta4], we obtain the following:

**Corollary 4.3.** *For any poset  $P$ ,*

$$2Z(\widehat{B}(P), m) = \Omega'(P_0, m).$$

**4.3. The  $\mathbf{cd}$ -index.** Theorem 4.1 may be used to give a combinatorial interpretation of the  $\mathbf{cd}$ -index of  $\widehat{B}(P)$ , as we now explain. For a graded poset  $Q$  of rank  $n$ , let  $(f_S(Q) : S \subseteq [n - 1])$  denote the flag  $f$ -vector of  $Q$ ; i.e.,  $f_S(Q)$  is the number of chains of size  $\#S$  in  $Q$  whose elements have ranks precisely in  $S$ . Define a polynomial of degree  $n - 1$  in the non-commuting variables  $\mathbf{a}$  and  $\mathbf{b}$  of degree 1 by

$$\Psi_Q := \sum_{S \subseteq [n-1]} f_S(Q) u_S,$$

where  $u_S = u_1 \cdots u_{n-1}$ ,  $u_i = \mathbf{b}$  if  $i \in S$  and  $u_i = \mathbf{a} - \mathbf{b}$  if  $i \notin S$ . Fine [BK] observed that when  $Q$  is Eulerian,  $\Psi_Q$  can be written as a polynomial in the variables  $\mathbf{c} = \mathbf{a} + \mathbf{b}$  and  $\mathbf{d} = \mathbf{ab} + \mathbf{ba}$ , called the  $\mathbf{cd}$ -index of  $Q$ ; for a sampling of work on the  $\mathbf{cd}$ -index, see [Sta3], [BER], [BE], [ER], and [E2]. If  $\Gamma$  is a cell complex such that  $\widehat{P}(\Gamma)$  is Eulerian, we may refer to  $\Psi_{\widehat{P}(\Gamma)}$  as the  $\mathbf{cd}$ -index of  $\Gamma$  or  $P(\Gamma)$ .

To connect the  $\mathbf{cd}$ -index to our work, we set up a one-to-one correspondence  $w \mapsto S_w$  between the set of  $\mathbf{cd}$ -words of degree  $n - 1$  and  $Peak_n$  given by

$$\mathbf{c}^{a_1} \mathbf{d} \mathbf{c}^{a_2} \mathbf{d} \cdots \mathbf{c}^{a_k} \mathbf{d} \mathbf{c}^{a_{k+1}} \mapsto \{\deg(\mathbf{c}^{a_1} \mathbf{d}), \deg(\mathbf{c}^{a_1} \mathbf{d} \mathbf{c}^{a_2} \mathbf{d}), \dots, \deg(\mathbf{c}^{a_1} \mathbf{d} \cdots \mathbf{c}^{a_k} \mathbf{d})\}.$$

---

<sup>4</sup>Our definition of an enriched  $P$ -partition agrees with Stembridge’s original definition of an enriched  $(P, \omega)$ -partition when  $\omega$  is a natural labeling of  $P$ .

For fixed  $n$ , let  $w_S$  denote the **cd**-word of degree  $n - 1$  associated to the peak set  $S \in \text{Peak}_n$ . For instance,  $S_{\mathbf{cddccdc}} = \{3, 5, 9\} \in \text{Peak}_{11}$  and  $w_{\{3,5,9\}} = \mathbf{cddccdc}$ . Given an Eulerian poset  $Q$  of rank  $n$  and a **cd**-word  $w$  of degree  $n - 1$ , let  $[w]$  denote the coefficient of the word  $w$  in  $\Psi_Q$ . A link between the **cd**-index and the peak algebra is provided by the identity [BHW, Corollary 2.2]

$$(4.5) \quad F_Q = \sum_{S \in \text{Peak}_n} \frac{[w_S]}{2^{1+\#S}} \cdot \theta_S.$$

This formula together with Theorem 4.1 and (4.3) yield the following:

**Theorem 4.4.** *For a naturally labeled poset  $P$ ,*

$$\Psi_{\widehat{B}(P)^*} = \sum_{\sigma \in \mathcal{L}(P_0)} 2^{\#\text{Peak}(\sigma)} w_{\text{Peak}(\sigma)}.$$

*In particular, the **cd**-indices of  $\widehat{B}(P)^*$  and  $\widehat{B}(P)$  have non-negative coefficients.*

Note that  $\Psi_{Q^*}$  is obtained from  $\Psi_Q$  by changing every **cd**-word  $w$  to  $w^*$ , the word consisting of the letters of  $w$  in reverse order [BER].

**Example 4.5.** If  $P$  is the poset from Figure 1(a) then

$$\begin{aligned} \Psi_{\widehat{B}(P)^*} &= w_{\text{Peak}(0123)} + w_{\text{Peak}(0213)} + w_{\text{Peak}(0231)} \\ &= w_\emptyset + 2w_{\{2\}} + 2w_{\{3\}} \\ &= \mathbf{ccc} + 2\mathbf{dc} + 2\mathbf{cd} \end{aligned}$$

and

$$\Psi_{\widehat{B}(P)} = \mathbf{ccc}^* + 2\mathbf{dc}^* + 2\mathbf{cd}^* = \mathbf{ccc} + 2\mathbf{cd} + 2\mathbf{dc}.$$

Theorem 4.4 provides further evidence for Stanley’s Gorenstein\* conjecture [Sta3, Conjecture 2.1], which is known to hold for face lattices of convex polytopes and oriented matroids:

**Conjecture 4.6** (Stanley). *The coefficients of the **cd**-index of a Gorenstein\* poset are non-negative.*

**Remark 4.7.** Conjecture 4.6 has received special attention in connection with a conjecture of Charney and Davis [CD] on the sign of the quantity

$$\kappa(\Gamma) := 1 - \frac{1}{2}f_0 + \frac{1}{4}f_1 - \cdots + \left(-\frac{1}{2}\right)^{d+1} f_d,$$

where  $f_i$  is the number of  $i$ -cells of the  $d$ -dimensional cell complex  $\Gamma$ . The Charney-Davis Conjecture predicts that  $(-1)^m \kappa(\Gamma) \geq 0$  whenever  $\Gamma$  is a flag complex triangulating a  $(2m - 1)$ -sphere. If  $\Gamma$  is the order complex of  $P \setminus \{\hat{0}, \hat{1}\}$ , where  $P$  is an Eulerian poset of rank  $2m + 1$ , then  $(-1)^m 2^{2m} \kappa(\Gamma)$  is the coefficient of  $\mathbf{d}^m$  of the **cd**-index of  $P$ ; see [Sta2] for additional details. For the face poset  $Q$  of a cell complex  $\Gamma$ , the order complex of  $Q \setminus \{\hat{0}\}$  is a flag complex and is the barycentric subdivision of  $\Gamma$ . Thus Theorem 4.4 proves a special case of the Charney-Davis Conjecture by supplying a combinatorial interpretation of the quantity  $(-1)^m \kappa(\Gamma)$  when  $\Gamma$  is the barycentric subdivision of a cellular sphere whose face poset is a signed Birkhoff poset.

Let  $\mathfrak{S}_n^0$  be the set of permutations of  $0, 1, \dots, n$  that start with 0. Taking  $P$  to be the antichain on  $[n]$  in Theorem 4.4 yields [BER, Proposition 8.1]:

**Corollary 4.8** (Billera, Ehrenborg, and Readdy). *Let  $\mathcal{C}_n$  be the face lattice of the  $n$ -dimensional cube. Then*

$$\Psi_{\mathcal{C}_n} = \sum_{\pi \in \mathfrak{S}_n^0} 2^{\#\text{Peak}(\pi)} w_{\text{Peak}(\pi)}.$$

On the other hand, if  $P$  is an  $n$ -element chain then a direct computation shows that  $\Psi_{\widehat{B}(P)} = \mathbf{c}^n$ . For an arbitrary, naturally labeled poset  $P$  on  $[n]$ ,  $\mathcal{L}(P_0)$  is a subset of  $\mathfrak{S}_n^0$ . Thus Theorem 4.4 and Corollary 4.8 imply the following:

**Corollary 4.9.** *The  $\mathbf{cd}$ -index of a signed Birkhoff poset of rank  $n+1$  is coefficient-wise maximized by the  $\mathbf{cd}$ -index of the  $n$ -dimensional hyperoctahedron and minimized by  $\mathbf{c}^n$ . In other words,  $\Psi_{\widehat{B}(P)}$  is coefficient-wise maximized when  $P$  is an antichain minimized when  $P$  is a chain.*

**4.4. Comparisons with oriented matroids.** Let  $\Gamma$  be a cell complex whose face poset is isomorphic to  $B(P)$  for some  $P$ . Let  $m$  be the number of minimal elements of  $P$ . The number of maximal cells of  $\Gamma$  is clearly  $2^m$ , which equals

$$(4.6) \quad \sum_{x \in J(P)} |\mu_{J(P)}(\hat{0}, x)|,$$

where  $\mu_{J(P)}$  is the Möbius function of  $J(P)$ . This is easily proved using well-known properties of the Möbius function of a distributive lattice; see, e.g., [Sta4, Example 3.9.6].

Formula (4.6) is reminiscent of a famous result of Zaslavsky’s expressing the  $f$ -vector of a hyperplane arrangement in terms of its intersection lattice  $[\mathbf{Z}]$ . He showed in particular that the number of regions in a hyperplane arrangement is  $\sum_{x \in L} |\mu_L(\hat{0}, x)|$ , where  $L$  is the intersection lattice. This result holds more generally in the setting of oriented matroids, where the intersection lattice is now replaced by the geometric lattice of flats. We refer the reader to [BLSWZ] for background and references in this area. Note that whereas a signed Birkhoff poset is completely determined by its underlying distributive lattice, an oriented matroid is not necessarily determined by its geometric lattice. In this respect, Zaslavsky’s formula is more surprising, and indeed more subtle, than (4.6). Bayer and Sturmfels [BS] extended Zaslavsky’s result by showing that the entire flag  $f$ -vector of an oriented matroid depends only on the underlying geometric lattice. The dependency is formulated explicitly in [BLSWZ, Proposition 4.6.2] in terms of the zero map, which “forgets the signs” of covectors. Using  $\varphi$  in place of the zero map, we have an essentially identical formula:

**Proposition 4.10.** *Let  $A_k < A_{k-1} < \dots < A_0 = \emptyset$  be a chain in  $J(P)$ . The number of chains in the preimage of  $c$  under the map  $\varphi : B(P) \rightarrow J(P)$  is*

$$\#\varphi^{-1}(c) = \prod_{i=1}^k \sum_{\substack{B \in J(P) \\ A_i \leq B \leq A_{i-1}}} |\mu_{J(P)}(A_i, B)|.$$

Billera, Ehrenborg, and Readdy described explicitly the  $\mathbf{cd}$ -index of an oriented matroid in terms of the flag  $f$ -vector of the underlying geometric lattice [BER]. To state their result, let us define a linear map  $\vartheta : \mathcal{Q} \rightarrow \Pi$  on the basis  $\{L_S\}$  by

$$\vartheta(L_{Des(\sigma)}) = \theta_{Peak(\sigma)}$$

for any fixed  $n \geq 1$  and any sequence of  $\sigma = (\sigma_1, \dots, \sigma_n)$ . We set  $\vartheta(1) = 1$ . It is easy to see that  $\vartheta$  is well-defined. Stembridge [Ste] introduced  $\vartheta$  as a means of relating the weight enumerator of  $P$ -partitions to that of enriched  $P$ -partitions. A basic consequence of the definition of  $\vartheta$  is that

$$(4.7) \quad \vartheta(K_P) = \widetilde{K}_P$$

for any poset  $P$ . It is also possible to view  $\vartheta$  as a specialization of a family of maps on noncommutative symmetric functions defined by Krob, Leclerc, and Thibon [KLT]. Many properties about these maps are proved in their work, and connections to the peak algebra are explained in [BHT].

The following is [BER, Theorem 3.1], stated in the present form in [BHW, Proposition 3.5]:

**Theorem 4.11** (Billera, Ehrenborg, and Readdy). *For the geometric lattice  $L$  of an oriented matroid  $\mathcal{O}$ ,*

$$2F_{T^*} = \vartheta(F_{L_0}),$$

where  $T$  is the face lattice of  $\mathcal{O}$ .

By comparison, using (4.2) and (4.7) we can restate Theorem 4.1 as follows:

**Theorem 4.12.** *For any poset  $P$ ,*

$$2F_{\widehat{B}(P)^*} = \vartheta(F_{J(P_0)}).$$

Theorem 4.12 summarizes the relationship between the flag enumerative invariants of a signed Birkhoff poset and its underlying distributive lattice.

**Remark 4.13.** It is possible to prove Theorem 4.12 (and hence Theorem 4.1) by adapting Billera, Ehrenborg, and Readdy’s proof of [BER, Theorem 3.1], with Proposition 4.10 now playing the role of [BLSWZ, Proposition 4.6.2].

### 5. An analog of the Distributive Lattice Conjecture

The *chain polynomial* of a graded poset  $Q$  of rank  $n$  is defined by  $C(Q, t) := \sum_{i=0}^n c_i t^i$ , where  $c_i$  is the number of chains in  $Q$  of length  $i$  from  $\hat{0}$  to  $\hat{1}$ . We state a well-known reformulation of a conjecture of Neggers [N] from 1978:

**Conjecture 5.1** (The Distributive Lattice Conjecture). *The chain polynomial of a distributive lattice has only real zeros.*

For a poset  $P$  on  $[n]$ ,  $n > 0$ , define  $W(P, t) := \sum_{\sigma \in \mathcal{L}(P)} t^{\#Des(\sigma)+1}$ . It is a standard exercise to show that if  $P$  is naturally labeled then  $(1-t)^n C(J(P), t/(1-t)) = W(P, t)$ . Thus  $C(J(P), t)$  has only real zeros if and only if  $W(P, t)$  does. More generally, the Neggers-Stanley Poset Conjecture predicts that  $W(P, t)$  has only real zeros for any labeling of  $P$ . It is a classical result that a polynomial with non-negative coefficients has only real zeros if and only if its coefficients form a *Pólya frequency sequence*. This would imply, in the case of  $W(P, t)$ , that the coefficients form a log-concave, unimodal sequence. We refer the reader to [Br1], [Br2], and [RW] for results and references related to the Neggers-Stanley Conjecture and Pólya frequency sequences.

The following is a signed analog of the Distributive Lattice Conjecture:

**Conjecture 5.2.** *For any poset  $P$ ,  $C(\widehat{B}(P), t)$  has only real zeros.*

We make some observations in support of this conjecture. In the enumerative theory of  $P$ -partitions,  $W(P, t)$  arises as the numerator of the rational generating function  $\sum_{m \geq 0} \Omega(P, m) t^m$  [Sta1]. Likewise, in the enumerative theory of enriched  $P$ -partitions, one has the identity [Ste, Theorem 4.1]

$$(5.1) \quad \sum_{m \geq 0} \Omega'(P, m) t^m = \frac{1}{2} \frac{(1+t)^{n+1}}{(1-t)^{n+1}} \cdot W' \left( P, \frac{4t}{(1+t)^2} \right),$$

where  $W'(P, t) := \sum_{\sigma \in \mathcal{L}(P)} t^{\#Peak(\sigma)+1}$  and  $P$  has  $n$  elements. Stembridge’s Enriched Poset Conjecture [Ste, Conjecture 4.3] predicts that  $W'(P, t)$  has only real zeros for any labeled poset  $P$ . This is known to be true when  $P$  is a disjoint union of labeled chains [Ste, Corollary 4.6] and has been verified for all labeled posets of size up to 7 and all naturally labeled posets of size 8. The relevance to our work is explained by the following:

**Proposition 5.3.** *For a naturally labeled poset  $P$ ,  $W'(P_0, t)$  has only real zeros if and only if  $C(\widehat{B}(P), t)$  has only real zeros.*

**Remark 5.4.** Proposition 5.3 shows that Conjecture 5.2 is a special case of the Enriched Poset Conjecture. Brenti’s work [Br1] indicates the usefulness of the distributive-lattice approach to the Neggers-Stanley Conjecture for naturally labeled posets. We hope that some progress can be made on the Enriched Poset Conjecture in light of Proposition 5.3.

## References

- [BK] M. Bayer and A. Klapper, *A new index for polytopes*, Discrete Comput. Geom. **6** (1991), 33-47.
- [BS] M. Bayer and B. Sturmfels, *Lawrence polytopes*, Canadian J. Math. **42** (1990), 62-79.
- [BHT] N. Bergeron, F. Hivert, J.-Y. Thibon, *The peak algebra and the Hecke-Clifford algebras at  $q = 0$* , preprint 2003.
- [BMSW] N. Bergeron, S. Mykytiuk, F. Sottile and S. van Willigenburg, *Non-commutative Pieri operators on posets*, *ÉJ. Comb. Theory, Series A* **91** (2000), 84-110.
- [BER] L. J. Billera, R. Ehrenborg and M. Readdy, *The  $\mathbf{c-d}$ -index of oriented matroids*, J. Comb. Theory, Series A **80** (1997), 79-105.
- [BE] L. J. Billera and R. Ehrenborg, *Monotonicity of the  $\mathbf{cd}$ -index for polytopes*, Math. Z. **233** (2000), 421-441.
- [BHW] L. J. Billera, S. K. Hsiao, and S. van Willigenburg, *Peak quasisymmetric functions and Eulerian enumeration*, Adv. Math. **176** (2003), no. 2, 248-276.
- [Bi] G. Birkhoff, *On the combination of subalgebras*, Proc. Cambridge Phil. Soc. **29** (1933), 441-464.
- [Bj1] A. Björner, *Shellable and Cohen-Macaulay partially ordered sets*, Trans. Amer. Math. Soc. **260** (1980) no. 1, 159-183.
- [Bj2] A. Björner, *Posets, regular CW complexes and Bruhat order*, Europ. J. Combinatorics **5** (1984), 7-16.
- [BLSWZ] A. Björner, M. Las Vergnas, B. Sturmfels, N. White, and G. M. Ziegler, *Oriented matroids*, Cambridge University Press, New York, 1993.
- [BW] A. Björner and M. Wachs, *On lexicographically shellable posets*, Trans. Amer. Math. Soc. **277** (1983), 323-341.
- [Br1] F. Brenti, *log-concave and Polya frequency sequences in combinatorics*, Mem. Amer. Math. Soc. (1989), no. 413.
- [Br2] F. Brenti, *Log-concave and unimodal sequences in algebra, combinatorics, and geometry: an update*, Contemporary Math. **178** (1994), 71-89.
- [CD] R. Charney and M. Davis, *The Euler characteristic of a nonpositively curved, piecewise-Euclidean manifold*, Pacific J. Math. **171** (1995), 117-137.
- [E1] R. Ehrenborg, *On posets and Hopf algebras*, Adv. Math. **119** (1996), no. 1, 1-25.
- [E2] R. Ehrenborg, *Lifting Inequalities for polytopes*, Adv. Math., to appear.
- [EH] R. Ehrenborg and G. Heteyi, *Flags and shellings of Eulerian cubical posets*, Ann. Comb. **4** (2000), 199-226.
- [ER] R. Ehrenborg and M. Readdy, *Coproducts and the  $\mathbf{cd}$ -index*, J. Alg. Combin. **8** (1998), 273-299.
- [G] I. M. Gessel, *Multipartite  $P$ -partitions and inner products of skew Schur functions*, Contemp. Math. **34** (1984), 289-301.
- [KLT] D. Krob, B. Leclerc, and J.-Y. Thibon, *Noncommutative symmetric functions II: Transformation of alphabets*, Internat. J. Alg. Comput. **7** (1997), no. 2, 181-264.
- [N] J. Neggers, *Representations of finite partially ordered sets*, J. Comb. Inform. Syst. Sci. no. **3**, 113-133.
- [R] V. Reiner, *Signed posets*, J. Comb. Theory, Series A **62** (1993), 324-360.
- [RW] V. Reiner and V. Welker, *On the Charney-Davis and Neggers-Stanley conjectures*, preprint 2002.
- [Sta1] R. Stanley, *Ordered structure and partitions*, Mem. Amer. Math. Soc. (1972), no. 119.
- [Sta2] R. Stanley, *A survey of Eulerian posets*, Polytopes: Abstract, Convex, and Computational (T. Bisztriczky, P. McMullen, R. Schneider, A. I. Weiss, eds.), NATO ASI Series C, vol. 440, Kluwer Academic Publishers, Dordrecht/Boston/London, 1994, pp. 301-333.
- [Sta3] R. Stanley, *Flag  $f$ -vectors and the  $\mathbf{cd}$ -index*, Math. Z. **216** (1994), 483-499.
- [Sta4] R. Stanley, *Enumerative Combinatorics, Vol. 1*, Cambridge Studies in Advanced Mathematics, Vol. 49, Cambridge University Press, Cambridge, UK, 1997.
- [Sta5] R. Stanley, *Enumerative Combinatorics, Vol. 2*, Cambridge Studies in Advanced Mathematics, Vol. 62, Cambridge University Press, Cambridge, UK, 1999.
- [Ste] J. Stembridge, *Enriched  $P$ -partitions*, Trans. Amer. Math. Soc. **349** (1997), no. 2, 763-788.
- [Z] T. Zaslavsky, *Facing up to arrangements: face count formulas for partitions of space by hyperplanes*, Mem. Amer. Math. Soc. **1** (1975), no. 154.

DEPARTMENT OF MATHEMATICS, UNIVERSITY OF MICHIGAN, ANN ARBOR, MI 48109-1109  
*E-mail address:* shsiao@umich.edu

## Pieri and Cauchy Formulae for Ribbon Tableaux

Thomas Lam

**Abstract.** In [LLT] Lascoux, Leclerc and Thibon introduced symmetric functions  $\mathcal{G}_\lambda$  which are spin and weight generating functions for ribbon tableaux. This article is aimed at studying these functions in analogy with Schur functions. In particular we will describe:

- a Pieri and dual-Pieri formula for ribbon functions,
- a ribbon Murnaghan-Nakayama formula,
- ribbon Cauchy and dual Cauchy identities,
- and a  $\mathbb{C}$ -algebra isomorphism  $\omega_n : \Lambda(q) \rightarrow \Lambda(q)$  which sends each  $\mathcal{G}_\lambda$  to  $\mathcal{G}_{\lambda'}$ .

We will show that the ribbon Pieri and Murnaghan–Nakayama rules are formally equivalent in a purely combinatorial manner. We will also connect the ribbon Cauchy and Pieri formulae to the combinatorics of ribbon insertion as studied by Shimozono and White [SW2]. In particular we give complete combinatorial proofs for the domino  $n = 2$  case.

**Résumé.** Dans [LLT], Lascoux, Leclerc et Thibon ont introduit des fonctions symétriques  $\mathcal{G}_\lambda$  qui sont les séries formelles pour tableaux des rubans, selon la rotation et le poids. Notre article étudie l'analogie entre ces fonctions et les fonctions de Schur. En particulier, nous décrivons:

- des formules ruban-Pieri et dual-ruban-Pieri,
- une formule de ruban Murnaghan–Nakayama,
- les identités ruban-Cauchy et dual-ruban-Cauchy pour fonctions de ruban,
- et un isomorphisme  $\mathbb{C}$ -algèbre  $\omega_n : \Lambda(q) \rightarrow \Lambda(q)$  qui envoie chaque  $\mathcal{G}_\lambda$  sur  $\mathcal{G}_{\lambda'}$ .

Nous montrerons que les règles Pieri de et Murnaghan–Nakayama sont formellement équivalentes dans une manière purement combinatoire. Nous connecterons aussi les formules ruban-Cauchy et ruban-Pieri au combinatoire d'insertion des rubans, comme étudié par Shimozono et White [SW2]. En particulier, nous donnons les preuves combinatoires complètes pour le cas domino  $n = 2$ .

### Introduction

This abstract is a much shortened version of the paper [Lam1]. It has been rewritten with the focus placed on combinatorial aspects. Many results and essentially all the proofs together with the representation theoretic details have been removed.

Let  $n \geq 1$  be a fixed integer and  $\lambda$  a partition with empty  $n$ -core. In analogy with the combinatorial definition of the Schur functions, Lascoux, Leclerc and Thibon [LLT] have defined a family of symmetric functions  $\mathcal{G}_\lambda(X; q) \in \Lambda(q)$  by:

$$\mathcal{G}_\lambda(X; q) = \sum_T q^{s(T)} \mathbf{x}^{w(T)}$$

---

1991 *Mathematics Subject Classification.* 17B,05E.

where the sum is over all *semistandard ribbon tableaux* of shape  $\lambda$ , and  $s(T)$  and  $w(T)$  are the spin and weight of  $T$  respectively. The definition of a semistandard ribbon tableau is analogous to the definition of semistandard Young tableaux, with boxes replaced by ribbons (or border strips) of length  $n$ . We shall loosely call the functions  $\mathcal{G}_\lambda(X; q)$  *ribbon functions*.

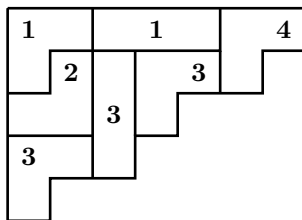

FIGURE 1. A semistandard 3-ribbon tableau with shape  $(7, 6, 4, 3, 1)$ , weight  $(2, 1, 3, 1)$  and spin 7.

When  $q = 1$  the ribbon functions become products of usual Schur functions. However, when the parameter  $q$  is introduced, it is no longer obvious that the functions  $\mathcal{G}_\lambda(X; q)$  are symmetric. The main aim of this paper will be to develop the theory of ribbon functions in the same way Schur functions are studied in the ring of symmetric functions. We shall see that the appropriate ‘ribbon’ analogues of the power sum, homogeneous and elementary symmetric functions is given by the the plethysm

$$f \mapsto f[(1 + q^2 + \dots + q^{2n-2})X].$$

We show that this leads to a ribbon Pieri rule in a natural way and also define ‘border ribbon strips’ which lead to a ribbon Murnaghan-Nakayama rule. These two rules are connected by showing that they are formally equivalent in a combinatorial fashion. The plethysm of the Cauchy kernel leads to a Cauchy and dual-Cauchy identity. We also describe a  $\mathbb{C}$ -algebra isomorphism  $\omega_n : \Lambda(q) \rightarrow \Lambda(q)$  which sends each skew ribbon function to the ribbon function corresponding to the conjugate.

It is well known that the corresponding formulae are important for Schur functions in representation theory and algebraic geometry.

Much of the interest in the ribbon functions has been focused on the  $q$ -Littlewood Richardson coefficients  $c_\lambda^\mu(q)$  of the expansion of  $\mathcal{G}_\lambda(X; q)$  in the Schur basis:

$$\mathcal{G}_\lambda(X; q) = \sum_{\mu} c_\lambda^\mu(q) s_\mu(X).$$

These are  $q$ -analogues of Littlewood Richardson coefficients. Using results of Varagnolo and Vasserot [VV], Leclerc and Thibon [LT] have shown that these coefficients are parabolic Kazhdan-Lusztig polynomials of type  $A$ . Results of Kashiwara and Tanisaki [KT] then imply that they are polynomials in  $q$  with non-negative coefficients. Much interest has also developed in connecting ribbon tableaux and the  $q$ -Littlewood Richardson coefficients to rigged configurations and the generalised Kostka polynomials defined by Kirillov and Shimozono [KS], Shimozono and Weyman [SW3], Schilling and Warnaar [SchW] and Shimozono [Shi].

To prove that the functions  $\mathcal{G}_\lambda(X; q)$  were symmetric Lascoux, Leclerc and Thibon connected them to Fock space representation  $\mathbf{F}$  of the quantum affine algebra  $U_q(\widehat{\mathfrak{sl}}_n)$ . The crucial property of  $\mathbf{F}$  is an action of a Heisenberg algebra  $H$ , commuting with the action of  $U_q(\widehat{\mathfrak{sl}}_n)$ , discovered by Kashiwara, Miwa and Stern [KMS]. In particular, they showed that as a  $U_q(\widehat{\mathfrak{sl}}_n) \times H$ -module,  $\mathbf{F}$  decomposes as

$$\mathbf{F} \cong V_{\Lambda_0} \otimes \mathbb{C}(q)[H_-]$$

where  $V_{\Lambda_0}$  is the highest weight representation of  $U_q(\widehat{\mathfrak{sl}}_n)$  with highest weight  $\Lambda_0$  and  $\mathbb{C}(q)[H_-]$  is the usual Fock space representation of the Heisenberg algebra.



In [Lam1], the connection between ribbon functions and the action of the Heisenberg algebra is made explicit by showing that the map  $\Phi : \mathbf{F} \rightarrow \mathbb{C}(q)[H_-]$  defined by

$$|\lambda\rangle \mapsto \mathcal{G}_\lambda$$

is a map of  $H$ -modules, after identifying  $\mathbb{C}(q)[H_-]$  with the ring of symmetric functions  $\Lambda(q)$  in the usual way. The map  $\Phi$  has the further remarkable property that it changes certain linear maps into algebra maps (for example leading to  $\omega_n$ ). Via the map  $\Phi$ , the action of the Heisenberg algebra leads to the ribbon Murnaghan-Nakayama and Pieri rules. Unfortunately, we will not be able to explore this aspect of the subject in this abstract.

We shall also connect our study of ribbon functions to more combinatorial aspects of ribbon tableaux. Using the domino insertion of Barbasch and Vogan, Garfinkle and Shimozono and White [BV, Gar, SW] we will give combinatorial proofs of the Pieri and Murnaghan-Nakayama formulae. The Cauchy and dual-Cauchy identities were observed earlier in [Lam]. Shimozono and White [SW2] have defined a ribbon-Schensted algorithm for  $n > 2$  which is also compatible with spin on ribbon tableaux. As we shall discuss, this algorithm gives a combinatorial proof of the first ribbon Pieri formula for  $k = 1$ , but appears to be insufficient to prove either the Cauchy identity or the higher Pieri rules.

**Acknowledgements.** This work is part of my dissertation written under the guidance of Richard Stanley. I am indebted to him for suggesting the study of ribbon tableaux and for providing me with assistance throughout. I would also like to thank Mark Shimozono and Ole Warnaar for pointing out a number of references.

## 1. Partitions and Tableaux

A distinguished integer  $n \geq 1$  will be fixed throughout the whole article. When  $n = 1$ , the reader may check that we recover the classical theory of Schur functions. We will use the usual notation and definitions for partitions, compositions, horizontal strips, border strips, standard and semistandard Young tableaux which can be found in [EC2, Mac].

Let  $b$  be a border strip. The height  $h(b)$  is the number of rows in  $b$ , minus 1. When a border strip has  $n$  squares for the distinguished (fixed) integer  $n$ , we will call it a ribbon. The height of the ribbon  $r$  will then be called its spin  $s(r)$ . The reader should be cautioned that in the literature the spin is usually defined as half of this.

Let  $\lambda$  be a partition. Its  $n$ -core, obtained from  $\lambda$  by removal of  $n$ -ribbons (until we are no longer able to), is denoted  $\tilde{\lambda}$ . The  $n$ -quotient of  $\lambda$  will be denoted  $(\lambda^{(0)}, \dots, \lambda^{(n-1)})$ . We shall write  $\mathcal{P}$  for the set of partitions. We will use  $\mathcal{P}_\delta$  to denote the set of partitions  $\lambda$  such that  $\tilde{\lambda} = \delta$  for an  $n$ -core  $\delta = \tilde{\delta}$ .

A ribbon tableau  $T$  of shape  $\lambda/\mu$  is a tiling of  $\lambda/\mu$  by  $n$ -ribbons and a filling of each ribbon with a positive integer (see Figure 1). We will use the convention that a ribbon tableau of shape  $\lambda$  where  $\tilde{\lambda} \neq \emptyset$  is simply a ribbon tableau of shape  $\lambda/\tilde{\lambda}$ . A ribbon tableau is semistandard if for each  $i$

- (1) removing all ribbons labelled  $j$  for  $j > i$  gives a valid skew shape  $\lambda_{\leq i}/\mu$  and,
- (2) the subtableau containing only the ribbons labelled  $i$  form a *horizontal  $n$ -ribbon strip*.

A horizontal  $n$ -ribbon strip is a skew shape tiled by ribbons such that the topright-most square of every ribbon touches the northern edge of the shape (see Figure 2). If such a tiling exists, it is necessarily unique. If the numbers occurring in a ribbon tableau are exactly  $\{1, 2, \dots, m\}$ , for some  $m$ , then the tableau is called standard.

We will often think of a ribbon tableau as a chain of partitions

$$\tilde{\lambda} = \mu^0 \subset \mu^1 \subset \dots \subset \mu^r = \lambda$$

where each  $\mu^{i+1}/\mu^i$  is a horizontal ribbon strip. The partitions  $\mu^i$  here are not to be confused with the  $n$ -quotient of  $\mu$ .

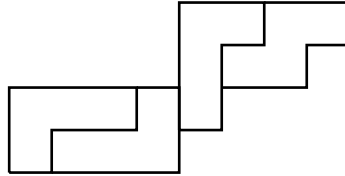

FIGURE 2. A horizontal 4-ribbon strip with spin 5.

The spin  $s(T)$  of a ribbon tableau  $T$  is the sum of the spins of its ribbons. The weight  $w(T)$  of a tableau is the composition counting the occurrences of each value in  $T$ .

All these concepts and statistics on ribbon tableau can be described in terms of the  $n$ -quotient (see [SSW]).

### 2. Symmetric Functions

In this section we briefly review some standard notation in symmetric function theory. The reader is referred to [Mac] for further details.

Let  $\Lambda_{\mathbb{Z}}$  denote the ring of symmetric functions with coefficients in  $\mathbb{Z}$ . Recall that  $\Lambda_{\mathbb{Z}}$  has a distinguished integral basis  $s_{\lambda}$  known as the Schur functions. Nearly all the results of this paper can be stated in  $\Lambda_{\mathbb{Z}}[q]$ , but some intermediate steps may require working in  $\Lambda = \Lambda_{\mathbb{C}}$  so we will use that as our symmetric function ring from now on. We will write  $\Lambda(q)$  for  $\Lambda_{\mathbb{C}} \otimes_{\mathbb{C}} \mathbb{C}(q)$ .

It is well known that the Schur functions  $s_{\lambda}$  are orthogonal with respect to a natural inner product  $\langle , \rangle$  on  $\Lambda$  and are unique up to signed permutation. We will denote the homogeneous, elementary, monomial and power sum symmetric functions by  $h_{\lambda}$ ,  $e_{\lambda}$ ,  $m_{\lambda}$  and  $p_{\lambda}$  respectively. Recall that we have  $\langle h_{\lambda}, m_{\mu} \rangle = \delta_{\lambda\mu}$  and  $\langle p_{\lambda}, p_{\mu} \rangle = z_{\lambda} \delta_{\lambda\mu}$  where  $z_{\lambda} = 1^{m_1(\lambda)} m_1(\lambda)! 2^{m_2(\lambda)} m_2(\lambda)! \dots$ . Each of  $\{p_i\}$ ,  $\{e_i\}$  and  $\{h_i\}$  generate  $\Lambda$ . We will write  $X$  to mean  $(x_1, x_2, \dots)$ . Thus  $s_{\lambda}(X) = s_{\lambda}(x_1, x_2, \dots)$ .

Let  $f \in \Lambda$ . We will recall the definition of the plethysm  $g \mapsto g[f]$ . Write  $g = \sum_{\lambda} c_{\lambda} p_{\lambda}$ . Then we have

$$g[f] = \sum_{\lambda} c_{\lambda} \prod_{i=1}^{l(\lambda)} f(x_1^{\lambda_i}, x_2^{\lambda_i}, \dots).$$

Thus the plethysm by  $f$  is the (unique) algebra isomorphism of  $\Lambda$  which sends  $p_k \mapsto f(x_1^k, x_2^k, \dots)$ . When  $f(x_1, x_2, \dots; q) \in \Lambda(q)$  for the distinguished element  $q$ , we define the plethysm as  $p_k \mapsto f(x_1^k, x_2^k, \dots; q^k)$ . Thus plethysm does not commute with specialising  $q$  to a complex number.

For example, the plethysm by  $(1 + q)p_1$  is given by sending

$$p_k \mapsto (1 + q^k)p_k$$

and extending to an algebra isomorphism  $\Lambda(q) \rightarrow \Lambda(q)$ . In such situations we will write  $f[(1 + q)X]$  for  $f[(1 + q)p_1]$ .

We will be particularly concerned with the plethysm given by  $(1 + q^2 + \dots + q^{2n-2})p_1$ . We will use  $\Upsilon_{q,n}$  to denote the map  $\Lambda(q) \rightarrow \Lambda(q)$  given by  $f \mapsto f[(1 + q^2 + \dots + q^{2n-2})X]$ .

### 3. Ribbon Functions

We will now define the central objects of this paper as introduced by Lascoux, Leclerc and Thibon in [LLT].

**Definition 3.1.** Let  $\lambda/\mu$  be a skew partition, tileable by  $n$ -ribbons. Define the symmetric functions  $\mathcal{G}_{\lambda/\mu} \in \Lambda(q)$  as:

$$\mathcal{G}_{\lambda/\mu}(X; q) = \sum_T q^{s(T)} \mathbf{x}^{w(T)}$$

where the sum is over all semistandard ribbon tableaux  $T$  of shape  $\lambda/\mu$  and  $\mathbf{x}^\alpha = x_1^{\alpha_1} x_2^{\alpha_2} \dots$ . When  $\lambda$  is a partition with non-empty  $n$ -core, we write  $\mathcal{G}_\lambda$  for  $\mathcal{G}_{\lambda/\bar{\lambda}}$ . These functions will be loosely called *ribbon functions*.

The fact that the functions  $\mathcal{G}_{\lambda/\mu}$  are symmetric is not obvious from the combinatorial definition. The proof requires the use of the action of the Heisenberg algebra on the Fock space of the quantum affine algebra  $U_q(\widehat{\mathfrak{sl}}_n)$ .

**Theorem 3.1 ([LLT]).** *The functions  $\mathcal{G}_{\lambda/\mu}(X; q)$  are symmetric functions.*

**Definition 3.2.** Let  $\lambda/\mu$  be a skew shape tileable by  $n$ -ribbons. Then define

$$\mathcal{K}_{\lambda/\mu, \alpha}(q) = \sum_T q^{s(T)},$$

the spin generating function of all semistandard ribbon tableaux  $T$  of shape  $\lambda/\mu$  and weight  $\alpha$ . Similarly let

$$\mathcal{L}_{\lambda/\mu, \alpha}(q) = \sum_T q^{s(T)}$$

summed over all column semistandard ribbon tableaux of shape  $\lambda/\mu$  and weight  $\alpha$ . A ribbon tableau is column semistandard if its conjugate is semistandard.

Thus  $\mathcal{G}_{\lambda/\mu}(X; q) = \sum_\alpha \mathcal{K}_{\lambda/\mu, \alpha}(q) \mathbf{x}^\alpha$ . We will now define *border ribbon strips*.

**Definition 3.3.** A *border ribbon strip*  $T$  is a connected skew shape  $\lambda/\mu$  with a distinguished tiling by disjoint non-empty horizontal ribbon strips  $T_1, \dots, T_a$  such that the diagram  $T_{+i} = \cup_{j \leq i} T_j$  is a valid skew shape for every  $i$  and for each connected component  $C$  of  $T_i$  we have

- (1) The shape of  $C \cup T_{i-1}$  is not a horizontal ribbon strip. Thus  $C$  has to ‘touch’  $T_{i-1}$  ‘from below’.
- (2) No sub horizontal ribbon strip  $C'$  of  $C$  which can be added to  $T_{i-1}$  satisfies the above property.

Since  $C$  is connected, this is equivalent to saying that only the rightmost ribbon of  $C$  touches  $T_{i-1}$ .

We further require that  $T_1$  is connected. The height  $h(T_i)$  of the horizontal ribbon strip  $T_i$  is the number of its components. The height  $h(T)$  of the border ribbon strip is defined as  $h(T) = (\sum_i h(T_i)) - 1$ . The size of the border ribbon strip  $T$  is then the total number of ribbons in  $\cup_i T_i$ . A border ribbon strip tableau is a chain  $T = \lambda_0 \subset \lambda_1 \subset \dots \subset \lambda_r$  of shapes such that  $\lambda_i/\lambda_{i-1}$  has been given the structure of a border ribbon strip. The type of  $T = \{\lambda_i\}$  is then the composition  $\alpha$  with  $\alpha_i$  equal to the size of  $\lambda_i/\lambda_{i-1}$ .

Define  $\mathcal{X}_\nu^{\mu/\lambda}$  as

$$\mathcal{X}_\nu^{\mu/\lambda}(q) = \sum_T (-1)^{h(T)} q^{s(T)}$$

summed over all border ribbon strip tableaux of shape  $\mu/\lambda$  and type  $\nu$ .

Note that this definition reduces to the usual definition of a border strip and border strip tableau when  $n = 1$ , in which case all the horizontal strips  $T_i$  are actually connected.

**Example 3.4.** Let  $n = 2$  and  $\lambda = (4, 2, 2, 1)$ . Suppose  $S$  is a border ribbon strip such that  $S_1$  has shape  $(7, 5, 2, 1)/(4, 2, 2, 1)$ , and thus it has size 3 and spin 1. We will now determine all the possible horizontal ribbon strips which may form  $S_2$ . It suffices to find the possible connected components that may be added. The domino  $(9, 5, 2, 1)/(7, 5, 2, 1)$  may not be added since its union with  $S_1$  is a horizontal ribbon strip, violating the conditions of the definition. The domino strip  $(8, 8, 2, 1)/(7, 5, 2, 1)$  is not allowed since the domino  $(8, 8, 2, 1)/(7, 7, 2, 1)$  can be removed and we still obtain a strip which touches  $S_1$ .

The legitimate connected horizontal ribbon strips  $C$  which can be added are

$$(7, 7, 2, 1)/(7, 5, 2, 1), (7, 5, 3, 3, 2, 1)/(7, 5, 2, 1) \quad \text{and} \quad (7, 5, 4, 1)/(7, 5, 2, 1)$$

as shown in Figure 3. Thus assuming  $S_2$  is non-empty, there are 5 choices for  $S_2$ , corresponding to taking some compatible combination of the three connected horizontal ribbon strips above.

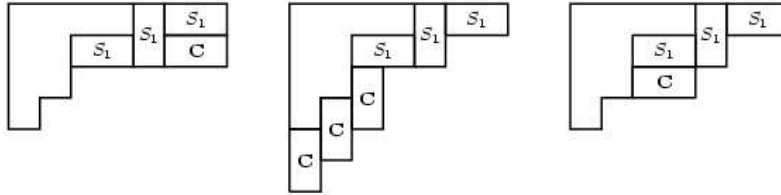

FIGURE 3. Connected horizontal strips  $C$  which can be added to  $S_1 = (7, 5, 2, 1)/(4, 2, 2, 1)$  to form a border ribbon strip. The resulting border ribbon strips all have height 1.

**Example 3.5.** As before let  $n = 2$ . We will calculate  $\chi_5^{\lambda/\mu}(q)$  for  $\lambda = (5, 5, 2)$  and  $\mu = (2)$ . The relevant border ribbon strips  $S$  are (successive differences of the following chains denote the  $S_i$ )

- $(2) \subset (5, 5, 2)$  with height 0 and spin 5,
- $(2) \subset (5, 3, 2) \subset (5, 5, 2)$  with height 1 and spin 3,
- $(2) \subset (5, 5) \subset (5, 5, 2)$  with height 1 and spin 3,
- $(2) \subset (5, 3) \subset (5, 5, 2)$  with height 2 and spin 1.

Thus

$$\chi_5^{\lambda/\mu}(q) = q^5 - 2q^3 + q.$$

#### 4. The Murnaghan-Nakayama Rule

The core calculation of the paper [Lam1] (performed using the action of the Heisenberg algebra on the Fock space of  $U_q(\widehat{\mathfrak{sl}}_n)$ ) is the ribbon Murnaghan-Nakayama Rule.

**Theorem 4.1** (Murnaghan-Nakayama Rule). *Let  $k \geq 1$  be an integer and  $\nu$  be a partition. Then*

$$(4.1) \quad \left(1 + q^{2k} + \dots + q^{2k(n-1)}\right) p_k \mathcal{G}_\nu(X; q) = \sum_{\mu} \chi_k^{\mu/\nu}(q) \mathcal{G}_\mu(X; q).$$

Also

$$k \frac{\partial}{\partial p_k} \mathcal{G}_\nu(X; q) = \sum_{\mu} \chi_k^{\nu/\mu}(q) \mathcal{G}_\mu(X; q).$$

**Example 4.1.** Let  $n = 2$  and consider  $(1 + q^4)p_2 \cdot 1$ . By the ribbon Murnaghan-Nakayama rule ( $\mathcal{G}_0 = 1$ ), this should equal to

$$\mathcal{G}_{(4)} + q\mathcal{G}_{(3,1)} + (q^2 - 1)\mathcal{G}_{(2,2)} - q\mathcal{G}_{(2,1,1)} - q^2\mathcal{G}_{(1,1,1,1)}.$$

We can compute directly that

$$\begin{aligned} \mathcal{G}_{(4)} &= h_2, & \mathcal{G}_{(3,1)} &= qh_2, & \mathcal{G}_{(2,1,1)} &= qe_2 \\ \mathcal{G}_{(2,2)} &= q^2h_2 + e_2, & \mathcal{G}_{(1,1,1,1)} &= q^2e_2, \end{aligned}$$

verifying Theorem 4.1 directly.

### 5. Murnaghan-Nakayama and Pieri

We now show that the ‘ribbon Murnaghan-Nakayama’ and ‘ribbon Pieri’ (to be made explicit in Section 6) rules are formally equivalent. In the case  $n = 1$  we obtain a direct combinatorial proof that the usual Pieri and Murnaghan-Nakayama rules are equivalent.

**Lemma 5.1.** *The power sum and homogeneous symmetric functions satisfy the following equation*

$$mh_m = p_{m-1}h_1 + p_{m-2}h_2 + \cdots + p_m.$$

PROOF. See (2.10) in [Mac]. □

Let  $V$  be a vector space over  $\mathbb{C}(q)$  and  $v_\lambda$  be vectors in  $V$  labelled by partitions. Recall the definitions of  $\mathcal{X}_k^{\mu/\lambda}(q)$ ,  $\mathcal{K}_{\mu/\lambda,k}(q)$  and  $\mathcal{L}_{\mu/\lambda,k}(q)$  from Section 3. Suppose  $\{P_k\}$  are commuting linear operators satisfying

$$P_k v_\lambda = \sum_{\mu} \mathcal{X}_k^{\mu/\lambda}(q) v_\mu \quad \text{for all } k$$

then we will say that the Murnaghan-Nakayama rule holds.

Suppose  $\{H_k\}$  are commuting linear operators on  $V$  satisfying

$$H_k v_\lambda = \sum_{\mu} \mathcal{K}_{\mu/\lambda,k}(q) v_\mu \quad \text{for all } k,$$

then we will say that Pieri formula holds.

Suppose  $\{E_k\}$  are commuting linear operators on  $V$  satisfying

$$E_k v_\lambda = \sum_{\mu} \mathcal{L}_{\mu/\lambda,k}(q) v_\mu \quad \text{for all } k,$$

then we will say that dual-Pieri formula holds.

If the skew shapes  $\mu/\lambda$  are replaced by  $\lambda/\mu$  in the above formulae, we get adjoint versions of these formulae which can be thought of as lowering operators. Thus if a set of commuting linear operators  $\{P_k^\perp\}$  satisfies

$$P_k^\perp v_\lambda = \sum_{\mu} \mathcal{X}_k^{\lambda/\mu}(q) v_\mu \quad \text{for all } k$$

then we will say the lowering Murnaghan-Nakayama rule holds, and similarly for  $\{E_k^\perp\}$  and  $\{H_k^\perp\}$ .

**Proposition 5.2.** *Fix  $n \geq 1$  as usual. Let  $\{H_k\}$  and  $\{P_k\}$  be commuting sets of linear operators satisfying the relations between  $h_k$  and  $p_k$  in  $\Lambda$ . Then the ribbon Murnaghan-Nakayama rule holds for  $\{P_k\}$  if and only if the ribbon Pieri rule holds for  $\{H_k\}$ .*

(SKETCH OF PROOF). The idea is to use Lemma 5.1 and to proceed by induction on  $k$ . Thus suppose that the Murnaghan-Nakayama rule holds for  $\{P_k\}$  and the ribbon Pieri rule holds for  $H_i$  for  $i \leq k$ . Then writing

$$kH_k = H_{k-1}P_1 + \cdots + P_k$$

we see that the action of  $kH_k$  on  $v_\lambda$  can be described in terms of ordered pairs  $(S, T)$  consisting of a border ribbon strip  $S$  and horizontal ribbon strip  $T$  (such that  $S$  is added first to  $\lambda$  then  $T$  later).

For the case  $n = 1$ , an involution  $\alpha$  can be defined on such pairs  $(S, T)$  which changes the sign of  $(-1)^{h(S)}$ . This involution  $\alpha$  is given by

- (1) If the ‘bottom’ horizontal strip  $S_1$  of  $S$  is such that  $T \cup S_1$  is a horizontal strip then we set  $\alpha(S, T) = (S - S_1, T \cup S_1)$
- (2) Otherwise  $T$  ‘touches’  $S$  from below. Let  $\alpha(S, T) = (S \cup T_1, T - T_1)$  where  $T_1$  is the unique sub horizontal strip which can be attached to  $S$  to form another border strip.

In both cases the height of the border strip will change and one can check that this is an involution when it is well defined. The contributions of these strips to  $kH_kv_\lambda$  cancel out since the total shape  $\lambda \cup S \cup T$  is fixed. The involution fails to be defined in the situation that  $S$  and  $T$  are both horizontal strips such that  $S \cup T$  is also a horizontal strip. This case gives exactly the contribution to  $kH_k$ , proving the inductive step.

The case for general  $n$  is more complicated, but the idea is similar. □

In fact we have the following theorem [Lam1].

**Theorem 5.1.** *Let  $\{H_i\}$ ,  $\{E_i\}$  and  $\{P_i\}$  be commuting operators on a vector space  $V$  over  $\mathbb{C}(q)$  satisfy the relations of  $h_i$ ,  $e_i$  and  $p_i$  in  $\Lambda$ . Let  $v_\lambda$  be a set of vectors in  $V$  indexed by partitions. Suppose that one of the Pieri, dual-Pieri and Murnaghan-Nakayama holds, then all three holds. The same is true for the lowering operators satisfying the same relation.*

### 6. Ribbon Pieri Formulae

Let  $n \geq 1$  be a fixed integer. Define the formal power series

$$H(t) = \prod_i \prod_{k=0}^{n-1} \frac{1}{1 - x_i q^{2k} t}$$

$$E(t) = \prod_i \prod_{k=0}^{n-1} (1 + x_i q^{2k} t).$$

As usual we may define symmetric functions  $\mathbf{h}_k$  and  $\mathbf{e}_k$  by  $H(t) = \sum_k \mathbf{h}_k t^k$  and similarly for  $\mathbf{e}_k$ . Note that we have suppressed the integer  $n$  from the notation. We shall see later that the definitions of these power series are completely natural in the context of Robinson-Schensted ribbon insertion.

In plethystic notation,  $\mathbf{h}_k = h_k[(1 + q^2 + \dots + q^{(2n-2)})X]$  and  $\mathbf{e}_k = e_k[(1 + q^2 + \dots + q^{(2n-2)})X]$ . The following theorem is an immediate consequence of Theorem 5.1 and Theorem 4.1.

**Theorem 6.1** (Ribbon Pieri Rule). *Let  $\lambda$  be a partition. Then*

$$(6.1) \quad \mathbf{h}_k \mathcal{G}_\lambda(X; q) = \sum_{\mu} q^{s(\mu/\lambda)} \mathcal{G}_\mu(X; q)$$

where the sum is over all partitions  $\mu$  such that  $\mu/\lambda$  is a horizontal  $n$ -ribbon strip with  $k$  ribbons. Here  $s(\mu/\lambda)$  refers to the spin of the unique tableau which is a horizontal ribbon strip of shape  $\mu/\lambda$ . Also

$$\mathbf{e}_k \mathcal{G}_\lambda(X; q) = \sum_{\mu} q^{s(\mu/\lambda)} \mathcal{G}_\mu(X; q)$$

where the sum is over all partitions  $\mu$  such that  $\mu/\lambda$  is a vertical  $n$ -ribbon strip with  $k$  ribbons. Here  $s(\mu/\lambda)$  refers to the spin of the unique tableau which is a vertical ribbon strip of shape  $\mu/\lambda$ .

Note that by Theorem 6.1, we have

$$\mathbf{h}_k = \sum_{\lambda} q^{\text{mspin}(\lambda)} \mathcal{G}_\lambda(X; q)$$

where the sum is over all  $\lambda$  with no  $n$ -core such that  $|\lambda| = kn$  with no more than  $n$  rows and  $\text{mspin}(\lambda)$  is the maximum spin of a ribbon tableau of shape  $\lambda$ . A similar formula holds for  $\mathbf{e}_k$ .

**Example 6.1.** Let  $n = 3$ ,  $k = 2$  and  $\lambda = (3, 1)$ . Then

$$\mathbf{h}_2 \mathcal{G}_{(3,1)} = \mathcal{G}_{(9,1)} + q \mathcal{G}_{(6,2,2)} + q^2 \mathcal{G}_{(4,4,2)} + q^2 \mathcal{G}_{(6,1,1,1,1)} + q^3 \mathcal{G}_{(3,3,2,1,1)} + q^4 \mathcal{G}_{(3,2,2,2,1)}.$$

We should remark that dual-Pieri formulae also follows and is equivalent to a cospin branching formula of [SSW]. These dual formulae are in some sense easier as they essentially only rely on the fact that ribbon functions are symmetric.

### 7. The Ribbon Involution $\omega_n$ and the Ribbon Cauchy Identity

We now define an involution  $w_n$  on  $\Lambda(q)$  which is essentially the involution  $v \mapsto v'$  on the Fock space  $\mathbf{F}$  of [LT]. However, this involution will turn out to be not just a semi-linear involution, but also a  $\mathbb{C}$ -algebra isomorphism of  $\Lambda(q)$ .

**Definition 7.1.** Define the *ribbon involution*  $w_n : \Lambda(q) \rightarrow \Lambda(q)$  as the semi-linear map satisfying  $w_n(q) = q^{-1}$  and

$$w_n(s_\lambda) = q^{(n-1)|\lambda|} s_{\lambda'}.$$

**Theorem 7.1.** *The map  $w_n$  is an  $\mathbb{C}$ -algebra homomorphism which is an involution. It maps  $\mathcal{G}_{\lambda/\mu}$  into  $\mathcal{G}_{(\lambda/\mu)'}$  for every skew shape  $\lambda/\mu$ .*

The proof of the first statement is not difficult. The proof of the second statement requires the use of calculations in the Fock Space  $\mathbf{F}$  which are generalisations of those in [LT], together with symmetric function manipulations.

Let us write the formal power series

$$\begin{aligned} \Omega(X; q) &= \prod_{i,j} \prod_{k=0}^{n-1} \frac{1}{1 - x_i y_j q^{2k}} \\ \tilde{\Omega}(X; q) &= \prod_{i,j} \prod_{k=0}^{n-1} (1 + x_i y_j q^{2k}). \end{aligned}$$

Then we have:

**Theorem 7.2** (Ribbon Cauchy Identity). *Fix  $n$  as usual and a  $n$ -core  $\delta$ . Then*

$$\Omega(X; q) = \sum \mathcal{G}_\lambda(X; q) \mathcal{G}_\lambda(Y; q)$$

and

$$\tilde{\Omega} = \sum_{\lambda \in \mathcal{P}_\delta} q^{(n-1)|\lambda/\tilde{\lambda}|} \mathcal{G}_{\lambda'}(X; q) \mathcal{G}_\lambda(Y; q^{-1}).$$

where the sum is over all  $\lambda$  such that  $\tilde{\lambda} = \delta$ .

Note that this does not imply that the  $\mathcal{G}_\lambda$  form an orthonormal basis under a certain inner product, as they are not linearly independent.

(SKETCH OF PROOF). Using results relating the Fock Space  $\mathbf{F}$  and  $\Lambda(q)$  in [Lam1] we have

$$s_\lambda[(1 + q^2 + \dots + q^{2n-2})X] = \sum_{\mu} c_\mu^\lambda(q) \mathcal{G}_\mu(X; q)$$

where the sum is over all  $\mu \in \mathcal{P}_\delta$ . Now multiply both sides by  $s_\lambda(Y)$  and sum over  $\lambda$ , giving the Cauchy identity. The dual Cauchy identity can be obtained via a calculation involving  $\omega_n$ .  $\square$

The factor of  $q^{(n-1)|\lambda/\tilde{\lambda}|}$  can be explained combinatorially by the fact that  $s(T') = q^{(n-1)|\lambda/\tilde{\lambda}|} s(T)$  for a ribbon tableau  $T$  and its conjugate  $T'$  satisfying  $sh(T) = \lambda$ .

### 8. Connections with Ribbon Insertion

In this section we put the ribbon Pieri formula (Theorem 6.1) and ribbon Cauchy identity (Theorem 7.2) in the context of ribbon Robinson-Schensted-Knuth (RSK) insertion, where both will be proven combinatorially and completely for the case  $n = 2$ .

**8.1. Robinson-Schensted-Knuth for usual Young tableaux.** Recall that the Robinson-Schensted bijection gives a bijection between permutations  $w \in S_m$  and pairs of standard Young tableaux (see [EC2]):

$$w \mapsto (P(w), Q(w)).$$

The semistandard generalisation of this is a bijection between biwords  $w$  and pairs of semistandard tableaux  $(P(w), Q(w))$  of the same shape. This immediately implies the usual Cauchy identity.

In fact the bijection is realised by the insertion algorithm which produces a semistandard tableau  $T' = (T \leftarrow i)$  given a semistandard tableau  $T$  and a number  $i$  to insert. An *increasing insertion* property of Robinson-Schensted-Knuth insertion guarantees that  $Q(w)$  will be semistandard. Let  $i < j$ . The increasing insertion property is the fact that the insertion path of  $i$  will always lie to the left of the path of  $j$  (if  $i$  is inserted before  $j$ ). This property is crucial to a combinatorial proof (see [EC2, p. 341]) of the Pieri rule:

$$h_k s_\lambda = \sum_{\mu} s_{\mu}.$$

We may interpret  $h_k$  as the generating function for a  $k$ -tuple of increasing positive integers  $(i_1 \leq i_2 \leq \dots \leq i_k)$ , and  $s_\lambda$  as the weight generating function of tableaux  $T$  with shape  $\lambda$ , as usual. Then a bijection from the left hand side to the right hand side is obtained by associating to a pair  $((i_1, \dots, i_k), T)$  the tableau

$$T' = ((\dots((T \leftarrow i_1) \leftarrow i_2) \dots) \leftarrow i_k).$$

The increasing insertion property guarantees that  $sh(T')/\lambda$  is indeed a horizontal strip.

**8.2. Domino insertion.** The above discussion also leads to proofs for the domino  $n = 2$  tableaux case. Barbasch and Vogan [BV] have defined domino insertion in connection with the primitive ideals of classical lie algebras. This was put into the usual bumping description by Garfinkle [Gar]. Recently, Shimozono and White [SW] have extended Garfinkle’s description to the semistandard case and connected it with mixed insertion. They also observed that it had the crucial color-to-spin property. A straightforward extension to the non-empty 2-core case was presented in [Lam].

A colored biletter is an ordered triple  $(c, i, j)$  where  $c \in \{0, 1\}$  is the color and  $i, j \in \{1, 2, \dots\}$ . A colored biword  $\omega$  is a multiset of colored biletters canonically ordered in some way, usually denoted in an array:

$$\mathbf{w} = \begin{pmatrix} c_1 \cdots c_m \\ i_1 \cdots i_m \\ j_1 \cdots j_m \end{pmatrix}$$

**Theorem 8.1.** Fix a 2-core  $\delta$ . There is a bijection between colored biwords  $\mathbf{w}$  of length  $m$  with two colors  $\{0, 1\}$  and pairs  $(P_d(\mathbf{w}), Q_d(\mathbf{w}))$  of semistandard domino tableaux with the same shape  $\lambda \in \mathcal{P}_\delta$  and  $|\lambda| = 2m + |\delta|$  with the following properties:

- The bijection has the color-to-spin property:

$$(8.1) \quad tc(\mathbf{w}) = s(P_d(\mathbf{w})) + s(Q_d(\mathbf{w}))$$

where  $tc(\mathbf{w})$  is the twice the sum of the colors in the top line of  $\mathbf{w}$ .

- The weight of  $P_d(\mathbf{w})$  is the weight of the lowest line of  $\mathbf{w}$ . The weight of  $Q_d(\mathbf{w})$  is the weight of the middle line of  $\mathbf{w}$ .



In fact the bijection is realized by an insertion procedure (denoted  $(T \leftarrow \gamma_i)$  where  $T$  is a domino tableau and  $\gamma_i$  is either a horizontal or vertical domino labelled  $i$ ) analogous to the usual Robinson-Schensted insertion.

This bijection immediately leads to the domino Cauchy identity ( $n = 2$  in Theorem 7.2). In [Lam], we have also described two dual domino insertion algorithms which are bijections between ‘dual colored biwords’ and pairs of semistandard tableaux of conjugate shape. This proves the dual domino Cauchy formula.

It further turns out that domino insertion has the following domino increasing insertion property. This was first shown by Shimozono and White by connecting domino insertion with mixed insertion. [Lam] gives a different proof using growth diagrams. This domino increasing insertion property can be described by specifying a total order  $<$  on dominoes as follows ( $\gamma_i$  denotes a domino labelled  $i$ )

- (1) If  $\gamma_i$  is horizontal and  $\gamma_j$  vertical then  $\gamma_i > \gamma_j$ .
- (2) If  $\gamma_i$  and  $\gamma_j$  are both horizontal then  $\gamma_i > \gamma_j$  if and only if  $i > j$ .
- (3) If  $\gamma_i$  and  $\gamma_j$  are both vertical then  $\gamma_i > \gamma_j$  if and only if  $i < j$ .

Under this order, domino insertion also has a increasing insertion property,

**Lemma 8.1.** *Let  $T$  be a domino tableau without the labels  $i$  and  $j$ . Set  $T' = (T \leftarrow \gamma_i)$  and  $T'' = (T' \leftarrow \gamma_j)$  for some dominoes  $\gamma_i$  and  $\gamma_j$ . Then  $sh(T'/T)$  lies to the left of  $sh(T''/T')$  if and only if  $\gamma_i < \gamma_j$ .*

Similarly, the dual domino insertion has a property which is dual to this. This increasing property is retained when the bijection is extended to the semistandard case (see [SW, Lam] for details).

**Proposition 8.2.** *Semistandard domino insertion gives a combinatorial proof of the Pieri rule (Theorem 6.1) for  $n = 2$ . Dual semistandard domino insertion gives a combinatorial proof of the dual Pieri rule for  $n = 2$ .*

PROOF. From the formal power series  $H(t)$ , it is easy to see that  $\mathbf{h}_k$  is the weight generating function for multisets  $\Gamma = \{\gamma_i\}_{i=1}^k$  of labelled dominoes of size  $k$ , where the weight of a labelled domino  $\gamma_i$  is given by

$$w(\gamma_i) = q^{2s(\gamma_i)} x_i.$$

Now fix a shape  $\lambda$ . Let  $S_1$  be the set of pairs  $(\Gamma, T)$  where  $\Gamma$  is a multiset of dominoes of size  $k$  and  $T$  is a semistandard domino tableau of shape  $\lambda$ . Let  $S_2$  be the set of semistandard tableaux  $T'$  such that  $sh(T')/\lambda$  is a horizontal domino strip of size  $k$ . We define a map  $\alpha : S_1 \rightarrow S_2$  by

$$\alpha(\Gamma, T) = ((\cdots((T \leftarrow \gamma_1)) \leftarrow \gamma_2) \cdots) \leftarrow \gamma_k),$$

where  $\gamma_i$  runs over the dominoes within  $\Gamma$ . Here the dominoes are inserted in the order of the increasing insertion property described above ensuring that the change in shape  $sh(T')/sh(T)$  is a horizontal strip. Taking the weights of these sets and using the color-to-spin property of domino insertion we see obtain Theorem 6.1 for  $n = 2$ . Using Theorem 8.1 one sees that  $\alpha$  is a bijection. The proof for the dual case is exactly analogous.  $\square$

**8.3. Shimozono and White’s ribbon insertion.** Shimozono and White [SW2] have described a ribbon insertion algorithm for general  $n$ . This can be described in a traditional bumping fashion or in terms of Fomin’s growth diagrams [Fom1, Fom2].

The ribbon insertion algorithm of [SW2] has the usual weight preserving properties, but also the spin to color property (8.1) which an earlier ribbon-RSK algorithm of Stanton and White [SW1] did not have. However, the algorithm stops short of being a bijection between colored biwords (with  $n$  colors) and pairs of semistandard ribbon tableaux. The algorithm is only described as a bijection  $\pi$  between colored words  $\mathbf{w}$  (not biwords) and a pair  $(P_r(\mathbf{w}), Q_r(\mathbf{w}))$  where  $P_r(\mathbf{w})$  is a semistandard ribbon tableau and  $Q_r(\mathbf{w})$  is a standard ribbon tableau. In particular the Cauchy identity of Theorem 7.2 does not immediately follow.

The algorithm also does not seem to possess a *ribbon increasing insertion* property. However one can at least salvage the following, which is just the first Pieri rule.

**Proposition 8.3.** *Shimozono and White's bijection  $\pi$  gives a combinatorial proof that*

$$(1 + q^2 + \dots + q^{2(n-1)})h_1\mathcal{G}_\lambda(X; q) = \sum_{\mu} q^{s(\mu/\lambda)}\mathcal{G}_\mu(X; q)$$

where the sum is over all  $\mu$  such that  $\mu/\lambda$  is a  $n$ -ribbon.

PROOF. As before we construct a weight preserving bijection between the two sides of the Pieri rule by:

$$(T, (c, j)) \mapsto T' = (T \leftarrow (c, j)).$$

Here  $(c, j)$  denotes an  $n$ -ribbon with color (or spin)  $c$  and label  $j$ . The color  $c$  ranges from 0 to  $n - 1$  and  $h_1$  is just the generating function for the labels  $j$ .  $\square$

Shimozono and White's ribbon insertion is determined by forcing all ribbons to bump by rows to another ribbon of the same spin (at least in the standard case). It is possible however to insist that all ribbons of a particular spin bump by columns instead. Unfortunately, it appears that none of these algorithms have a ribbon increasing insertion property.

## References

- [BV] D. BARBASCH, D. VOGAN, Primitive ideals and orbital integrals on complex classical groups, *Math. Ann.*, **259** (1982), 153-199.
- [Fom1] S. FOMIN, Duality of graded graphs, *J. Algebraic Combin.*, **3** (1994), 357-404.
- [Fom2] S. FOMIN, Schensted algorithms for dual graded graphs, *J. Algebraic Combin.*, **4** (1995), 5-45.
- [Gar] D. GARFINKLE, On the classification of primitive ideals for complex classical Lie algebras II, *Compositio Math.*, **81** (1992) 307-336.
- [KMS] M. KASHIWARA, T. MIWA, E. STERN, Decomposition of  $q$ -deformed Fock spaces, *Slecta Math.* **1** (1996) 787.
- [KT] M. KASHIWARA AND T. TANISAKI, Parabolic Kazhdan-Lusztig polynomials and Schubert varieties, *J. Algebra* **249** (2002), no.2, 306-325.
- [KS] A.N. KIRILLOV AND M. SHIMOZONO, A generalization of the Kostka-Foulkes polynomials, *J. Algebraic Combin.* **15** (2002), no. 1, 27-69.
- [Lam] T. LAM, Growth diagrams, Domino insertion and Sign-imbalance, preprint, 2003, math.CO/0308265.
- [Lam1] T. LAM, Ribbon Tableaux and the Heisenberg Algebra, preprint, 2003, math.CO/0310250.
- [LLT1] A. LASCoux, B. LECLERC, AND J.-Y. THIBON, Hecke algebras at roots of unity and crystal bases of quantum affine algebras, *Commun. Math. Phys.* **181** (1996), 205-263.
- [LLT] A. LASCoux, B. LECLERC, AND J.-Y. THIBON, Ribbon tableaux, Hall-Littlewood symmetric functions, quantum affine algebras, and unipotent varieties, *J. Math. Phys.* **38**(3) (1997), 1041-1068.
- [LT] B. LECLERC, J.-Y. THIBON, Littlewood-Richardson coefficients and Kazhdan-Lusztig polynomials; *Combinatorial Methods in Representation Theory*, Advanced Studies in Pure Mathematics 28, (2000), 155-220.
- [Mac] I. MACDONALD, *Symmetric Functions and Hall Polynomials*, Oxford University Press, 1995.
- [SchW] A. SCHILLING AND S.O. WARNAAR, Inhomogeneous lattice paths, generalized Kostka polynomials and  $A_{n-1}$  supernomials, *Comm. Math. Phys.*, **202** (1999), no. 2, 359-401.
- [SSW] A. SCHILLING, M. SHIMOZONO AND D.E. WHITE, Branching formula for  $q$ -Littlewood-Richardson coefficients, *Advances in Applied Mathematics*, **30** (2003), 258-272.
- [Shi] M. SHIMOZONO, Affine type A crystal structure on tensor products of rectangles, Demazure characters, and nilpotent varieties. *J. Algebraic Combin.*, **15** (2002), no.2, 151-187.
- [SW3] M. SHIMOZONO AND J. WEYMAN, Characters of modules supported in the closure of a nilpotent conjugacy class, *European J. Combin.*, **21** (2000), no. 2, 257-288.
- [SW] M. SHIMOZONO AND D.E. WHITE, A color-to-spin domino Schensted algorithm, *Electron. J. Combinatorics*, **8** (2001).
- [SW2] M. SHIMOZONO AND D.E. WHITE, Color-to-spin ribbon Schensted algorithms, *Discrete Math.*, **246** (2002), 295-316.
- [EC2] R. STANLEY, *Enumerative Combinatorics, Vol 2*, Cambridge, 1999.

- [SW1] D. STANTON AND D. WHITE, A Schensted algorithm for rim-hook tableaux, *J. Combin. Theory Ser. A.*, **40** (1985), 211-247.
- [VV] M. VARAGNOLO, E. VASSEROT, On the decomposition matrices of the quantized Schur algebra, *DUKE MATH. J.* **100** (1999), 267-297.
- [Whi] D. WHITE, Sign-balanced posets, *J. Combin. Theory Ser. A* **95** (2001), no. 1, 1-38.

DEPARTMENT OF MATHEMATICS, M.I.T., CAMBRIDGE, MA, 02139, USA.  
*E-mail address:* `thomasl@math.mit.edu`



## $q, t$ -Kostka Polynomials and the Affine Symmetric Group

Luc Lapointe and Jennifer Morse

**Abstract.** *The  $k$ -Young lattice  $Y^k$  is a partial order on partitions with no part larger than  $k$  that originated [LLM] from the study of  $k$ -Schur functions  $s_\lambda^{(k)}$ , symmetric functions that form a natural basis of the space spanned by homogeneous functions indexed by  $k$ -bounded partitions. The chains in the  $k$ -Young lattice are induced by a Pieri-type rule experimentally satisfied by the  $k$ -Schur functions. Here, using a natural bijection between  $k$ -bounded partitions and  $k+1$ -cores, we can identify chains in the  $k$ -Young lattice with certain tableaux on  $k+1$  cores. This identification reveals that the  $k$ -Young lattice is isomorphic to the weak order on the quotient of the affine symmetric group  $\tilde{S}_{k+1}$  by a maximal parabolic subgroup. From this, the conjectured  $k$ -Pieri rule implies that the  $k$ -Kostka matrix connecting the homogeneous basis  $\{h_\lambda\}_{\lambda \in Y^k}$  to  $\{s_\lambda^{(k)}\}_{\lambda \in Y^k}$  may now be obtained by counting appropriate classes of tableaux on  $k+1$ -cores. This suggests that the conjecturally positive  $k$ -Schur expansion coefficients for Macdonald polynomials (reducing to  $q, t$ -Kostka polynomials for large  $k$ ) could be described by a  $q, t$ -statistic on these tableaux, or equivalently on reduced words for affine permutations.*

**Résumé.** *Un ordre partiel  $Y^k$  sur les partitions dont les parties ne dépassent pas un certain entier positif  $k$  tire son origine de l'étude de fonctions de Schur généralisées [LLM], fonctions symétriques formant une base de l'espace engendré par les fonctions homogènes indicées par des partitions  $k$ -bornées. Les chaînes dans le treillis  $Y^k$  sont induites par une règle du type Pieri que satisfont expérimentalement les fonctions de  $k$ -Schur. En utilisant une bijection naturelle entre les partitions  $k$ -bornées et les  $k+1$ -cores, nous obtenons une correspondance entre les chaînes dans le treillis  $Y^k$  et certains remplissages de  $k+1$ -cores. Cette correspondance révèle que le treillis  $Y^k$  est isomorphe à l'ordre faible du groupe symétrique affine  $\tilde{S}_{k+1}$  modulo un sous-groupe parabolique maximal. La règle de Pieri expérimentale implique ainsi que la matrice de  $k$ -Kostka connectant les bases  $\{h_\lambda\}_{\lambda \in Y^k}$  et  $\{s_\lambda^{(k)}\}_{\lambda \in Y^k}$  peut être obtenue en énumérant certaines classes de tableaux sur les  $k+1$ -cores, et suggère entre autres que les coefficients de développements, que nous conjecturons positifs, des polynômes de Macdonald en termes de fonctions de  $k$ -Schur (se réduisant aux polynômes de  $q, t$ -Kostka lorsque  $k$  est grand) pourraient être décrits par une  $q, t$ -statistique sur ces tableaux, ou de façon équivalente, par une  $q, t$ -statistique sur les décompositions réduites de certaines permutations affines.*

---

1991 *Mathematics Subject Classification.* Primary 05E05.

*Key words and phrases.* symmetric functions, affine symmetric group, Macdonald polynomials.

L. Lapointe is supported in part by FONDECYT (Chile) grant #1030114.

J. Morse is supported in part by NSF grant #DMS-0231730.

### 1. Introduction

**1.1. The  $k$ -Young lattice.** Recall that  $\lambda$  is a successor of a partition  $\mu$  in the Young lattice when  $\lambda$  is obtained by adding an addable corner to  $\mu$  where partitions are identified by their Ferrers diagrams. This relation, which we denote “ $\mu \rightarrow \lambda$ ”, occurs naturally in the classical Pieri rule

$$(1.1) \quad h_1[X] s_\mu[X] = \sum_{\lambda: \mu \rightarrow \lambda} s_\lambda[X],$$

and the partial order of the Young lattice may be defined as the transitive closure of  $\mu \rightarrow \lambda$ . It was experimentally observed that the  $k$ -Schur functions [LLM, LM1] satisfy the rule

$$(1.2) \quad h_1[X] s_\mu^{(k)}[X] = \sum_{\lambda: \mu \rightarrow_k \lambda} s_\lambda^{(k)}[X],$$

where “ $\mu \rightarrow_k \lambda$ ” is a certain subrelation of “ $\mu \rightarrow \lambda$ ”. This given, the partial order of the  $k$ -Young lattice  $Y^k$  is defined as the transitive closure of  $\mu \rightarrow_k \lambda$ .

The precise definition of the relation  $\mu \rightarrow_k \lambda$  stems from another “Schur” property of  $k$ -Schur functions. Computational evidence suggests that the usual  $\omega$ -involution for symmetric functions acts on  $k$ -Schur functions according to the formula

$$(1.3) \quad \omega s_\mu^{(k)}[X] = s_{\mu^{\omega_k}}^{(k)}[X],$$

where the map  $\mu \mapsto \mu^{\omega_k}$  is an involution on  $k$ -bounded partitions called “ $k$ -conjugation” generalizing partition conjugation  $\mu \mapsto \mu'$ . Then viewing the covering relations on the Young lattice as

$$(1.4) \quad \mu \rightarrow \lambda \iff |\lambda| = |\mu| + 1 \quad \& \quad \mu \subseteq \lambda \quad \& \quad \mu' \subseteq \lambda',$$

we accordingly, in our previous work [LLM], defined  $\mu \rightarrow_k \lambda$  in terms of the involution  $\mu \mapsto \mu^{\omega_k}$  by

$$(1.5) \quad \mu \rightarrow_k \lambda \iff |\lambda| = |\mu| + 1 \quad \& \quad \mu \subseteq \lambda \quad \& \quad \mu^{\omega_k} \subseteq \lambda^{\omega_k}.$$

Thus only certain addable corners may be added to a partition  $\mu$  to obtain its successors in the  $k$ -Young lattice. We shall call such corners the “ $k$ -addable corners” of  $\mu$ .

The precise determination of  $k$ -addable corners relies on a bijection between  $k$ -bounded partitions and the set of  $k + 1$ -cores (partitions with no  $k + 1$ -hooks). For any  $k + 1$ -core  $\gamma$ , we define

$$\mathbf{p}(\gamma) = (\lambda_1, \dots, \lambda_\ell)$$

where  $\lambda_i$  is the number of cells with  $k$ -bounded hook length in row  $i$  of  $\gamma$ . It turns out that  $\mathbf{p}(\gamma)$  is a  $k$ -bounded partition and that the correspondence  $\gamma \mapsto \mathbf{p}(\gamma)$  bijectively maps  $k + 1$ -cores onto  $k$ -bounded partitions. With  $\lambda \mapsto \mathbf{c}(\lambda)$  denoting the inverse of  $\mathbf{p}$ , we define the  $k$ -conjugation of a  $k$ -bounded partition  $\lambda$  to be

$$(1.6) \quad \lambda^{\omega_k} = \mathbf{p}(\mathbf{c}(\lambda)').$$

That is, if  $\gamma$  is the  $k + 1$ -core corresponding to  $\lambda$ , then  $\lambda^{\omega_k}$  is the partition whose row lengths equal the number of  $k$ -bounded hooks in corresponding rows of  $\gamma'$ . This reveals that  $k$ -conjugation, which originally emerged from the action of the  $\omega$  involution on  $k$ -Schur functions, is none other than the  $\mathbf{p}$ -image of ordinary conjugation of  $k + 1$ -cores.

The  $\mathbf{p}$ -bijection then leads us to a characterization for  $k$ -addable corners that determine successors in the  $k$ -Young lattice. By labeling every square  $(i, j)$  in the  $i^{\text{th}}$  row and  $j^{\text{th}}$  column by its “ $k + 1$ -residue”,  $j - i \pmod{k + 1}$ , we find

**(Theorem 4.1)** *Let  $c$  be any addable corner of a  $k$ -bounded partition  $\lambda$  and  $c'$  (of  $k + 1$ -residue  $i$ ) be the addable corner of  $\mathbf{c}(\lambda)$  in the same row as  $c$ .  $c$  is  $k$ -addable if and only if  $c'$  is the highest addable corner of  $\mathbf{c}(\lambda)$  with  $k + 1$ -residue  $i$ .*

This characterization of  $k$ -addability leads us to a notion of standard  $k$ -tableaux which we prove are in bijection with saturated chains in the  $k$ -Young lattice.

**(Definition 4.6)** Let  $\gamma$  be a  $k + 1$ -core and  $m$  be the number of  $k$ -bounded hooks of  $\gamma$ . A standard  $k$ -tableau of shape  $\gamma$  is a filling of the cells of  $\gamma$  with the letters  $1, 2, \dots, m$  which is strictly increasing in rows and columns and such that the cells filled with the same letter have the same  $k + 1$ -residue.

**(Theorem 4.9)** The saturated chains in the  $k$ -Young lattice joining the empty partition  $\emptyset$  to a given  $k$ -bounded partition  $\lambda$  are in bijection with the standard  $k$ -tableaux of shape  $\mathfrak{c}(\lambda)$ .

We then consider the affine symmetric group  $\tilde{S}_{k+1}$  modulo a maximal parabolic subgroup denoted by  $S_{k+1}$ . Bruhat order on the minimal coset representatives of  $\tilde{S}_{k+1}/S_{k+1}$  can be defined in terms of simple containment of  $k + 1$ -core diagrams (this connection is stated precisely by Lascoux in [L] and is equivalent to results in [MM, BB]). From this, stronger relations among  $k + 1$ -core diagrams can be used to describe the weak order on such coset representatives. We are thus able to prove that our new characterization of the  $k$ -Young lattice chains implies an isomorphism between the  $k$ -Young lattice and the weak order on these coset representatives. Consequently, a bijection between the set of  $k$ -tableaux of a given shape  $\mathfrak{c}(\lambda)$  and the set of reduced decompositions for a certain affine permutation  $\sigma_\lambda \in \tilde{S}_{k+1}/S_{k+1}$  can be achieved by mapping:

$$(1.7) \quad \mathbf{w} : T \mapsto s_{i_\ell} \cdots s_{i_2} s_{i_1},$$

where  $i_a$  is the  $k + 1$ -residue of letter  $a$  in the standard  $k$ -tableau  $T$ . A by-product of this result is a simple bijection between  $k$ -bounded partitions and affine permutations in  $\tilde{S}_{k+1}/S_{k+1}$ :

$$(1.8) \quad \phi : \lambda \mapsto \sigma_\lambda,$$

where  $\sigma_\lambda$  corresponds to the reduced decomposition obtained by reading the  $k + 1$ -residues of  $\lambda$  from right to left and from top to bottom. It is shown in [LMW] that this bijection, although algorithmically distinct, is equivalent to the one presented by Björner and Brenti [BB] using a notion of inversions on affine permutations. It follows from our results that Eq. (1.2) reduces simply to

$$(1.9) \quad h_1[X] s_{\phi^{-1}(\sigma)}^{(k)}[X] = \sum_{\sigma <_w \tau} s_{\phi^{-1}(\tau)}^{(k)}[X],$$

where the sum is over all permutations that cover  $\sigma$  in the weak order on  $\tilde{S}_{k+1}/S_{k+1}$ .

As will be detailed in § 1.2, Theorem 4.9 also plays a role in the theory of Macdonald polynomials and the study of  $k$ -Schur functions, thus motivating a semi-standard extension of Definition 4.6:

**(Definition 6.1)** Let  $m$  be the number of  $k$ -bounded hooks in a  $k + 1$ -core  $\gamma$  and let  $\alpha = (\alpha_1, \dots, \alpha_r)$  be a composition of  $m$ . A semi-standard  $k$ -tableau of shape  $\gamma$  and evaluation  $\alpha$  is a column strict filling of  $\gamma$  with the letters  $1, 2, \dots, r$  such that the collection of cells filled with letter  $i$  is labeled with exactly  $\alpha_i$  distinct  $k + 1$ -residues.

As with the ordinary semi-standard tableaux, we show that there are no semi-standard  $k$ -tableau under conditions relating to dominance order on the shape and evaluation. An analogue of Theorem 4.9 can then be used to show that this coincides with unitriangularity of coefficients in the  $k$ -Schur expansion of homogeneous symmetric functions and suggests that the  $k$ -tableaux should have statistics to combinatorially describe the  $k$ -Schur function expansion of the Hall-Littlewood polynomials. The analogue of Theorem 4.9 relies on the following definition: with the pair of  $k$ -bounded partitions  $\lambda, \mu$  defined to be “ $r$ -admissible” if and only if  $\lambda/\mu$  and  $\lambda^{\omega_k}/\mu^{\omega_k}$  are respectively horizontal and vertical  $r$ -strips, we say a sequence of partitions

$$\emptyset = \lambda^{(0)} \longrightarrow \lambda^{(1)} \longrightarrow \lambda^{(2)} \longrightarrow \dots \longrightarrow \lambda^{(\ell)}$$

is  $\alpha$ -admissible when  $\lambda^{(i)}, \lambda^{(i-1)}$  is a  $\alpha_i$ -admissible pair for  $i = 1, \dots, \ell$ . It turns out that all  $\alpha$ -admissible sequences are in fact chains in the  $k$ -Young lattice and that Theorem 4.9 extends to:

**(Theorem 6.6)** Let  $m$  be the number of  $k$ -bounded hooks in a  $k + 1$ -core  $\gamma$  and let  $\alpha$  be a composition of  $m$ . The collection of  $\alpha$ -admissible chains joining  $\emptyset$  to  $\mathfrak{p}(\gamma)$  is in bijection with the semi-standard  $k$ -tableaux of shape  $\gamma$  and evaluation  $\alpha$ .

As mentioned, the root of our work lies in the study of symmetric functions. We conclude our introduction with a summary of these ideas.

**1.2. Macdonald expansion coefficients.** The  $k$ -Young lattice emerged from the experimental Pieri rule (1.2) satisfied by  $k$ -Schur functions. In turn,  $k$ -Schur functions have arisen from a close study of Macdonald polynomials. To appreciate the role of our findings in the theory of Macdonald polynomials we shall briefly review this connection. To begin, we consider a modification of the Macdonald integral form [M]  $J_\lambda[X; q, t]$  obtained by plethystic substitution:

$$(1.10) \quad H_\mu[X; q, t] = J_\mu\left[\frac{X}{1-q}; q, t\right] = \sum_{\lambda \vdash n} K_{\lambda\mu}(q, t) s_\lambda[X],$$

where  $K_{\lambda\mu}(q, t) \in \mathbb{N}[q, t]$  are known as the  $q, t$ -Kostka polynomials. Formula (1.10), when  $q = t = 1$ , reduces to

$$(1.11) \quad h_1^n = \sum_{\lambda \vdash n} f_\lambda s_\lambda[X],$$

where  $f_\lambda$  is the number of standard tableaux of shape  $\lambda$ . This given, one of the outstanding problems in algebraic combinatorics is to associate a pair of statistics  $a_\mu(T), b_\mu(T)$  on standard tableaux to the partition  $\mu$  so that

$$(1.12) \quad K_{\lambda\mu}(q, t) = \sum_{T \in ST(\lambda)} q^{a_\mu(T)} t^{b_\mu(T)},$$

where “ $ST(\lambda)$ ” denotes the collection of standard tableaux of shape  $\lambda$ .

In previous work [LLM, LM1], we proposed a new approach to the study of the  $q, t$ -Kostka polynomials. This approach is based on the discovery of a certain family of symmetric functions  $\{s_\lambda^{(k)}[X; t]\}_{\lambda \in Y^k}$  for each integer  $k \geq 1$ , which we have shown [LM1] to be a basis for the space  $\Lambda_t^{(k)}$  spanned by the Macdonald polynomials  $H_\mu[X; q, t]$  indexed by  $k$ -bounded partitions. This revealed a mechanism underlying the structure of the coefficients  $K_{\lambda\mu}(q, t)$ . To be precise, for  $\mu, \nu \in Y^k$ , consider

$$(1.13) \quad H_\mu[X; q, t] = \sum_{\nu \in Y^k} K_{\nu\mu}^{(k)}(q, t) s_\nu^{(k)}[X; t], \text{ and } s_\nu^{(k)}[X; t] = \sum_{\lambda} \pi_{\lambda\nu}(t) s_\lambda[X].$$

We then we have the factorization

$$(1.14) \quad K_{\lambda\mu}(q, t) = \sum_{\nu \in Y^k} \pi_{\lambda\nu}(t) K_{\nu\mu}^{(k)}(q, t).$$

It was experimentally observed (proven for  $k = 2$  in [LM0, LM1]) that  $K_{\nu\mu}^{(k)}(q, t) \in \mathbb{N}[q, t]$  and  $\pi_{\lambda\nu}(t) \in \mathbb{N}[t]$ . This suggests that the problem of finding statistics for  $K_{\lambda\mu}(q, t)$  may be decomposed into two analogous problems for  $K_{\nu\mu}^{(k)}(q, t)$  and  $\pi_{\lambda\nu}(t)$ . We also have experimental evidence to support that  $K_{\lambda\mu}(q, t) - K_{\nu\mu}^{(k)}(q, t) \in \mathbb{N}[q, t]$  which implies that  $s_\lambda^{(k)}[X; t]$ -expansions are formally simpler.

These developments prompted a close study of the polynomials  $s_\lambda^{(k)}[X; 1] = s_\lambda^{(k)}[X]$ . In addition to (1.2), it was also conjectured that these polynomials satisfy the more general rule

$$(1.15) \quad h_r[X] s_\mu^{(k)}[X] = \sum_{\substack{\lambda/\mu = \text{horizontal } r\text{-strip} \\ \lambda^{\omega k}/\mu^{\omega k} = \text{vertical } r\text{-strip}}} s_\lambda^{(k)}[X].$$

Iteration of (1.2) starting from  $s_\emptyset[X] = 1$  yields

$$(1.16) \quad h_1^n[X] = \sum_{\lambda \in Y^k} K_{\lambda, 1^n}^{(k)} s_\lambda^{(k)}[X],$$



while iterating (1.15) for suitable choices of  $r$  gives the  $k$ -Schur function expansion of an  $h$ -basis element indexed by any  $k$ -bounded partition  $\mu$ . That is,

$$(1.17) \quad h_\mu[X] = \sum_{\lambda \in Y^k} K_{\lambda\mu}^{(k)} s_\lambda^{(k)}[X]$$

Since  $s_\lambda^{(k)}[X] = s_\lambda[X]$  when all the hooks of  $\lambda$  are  $k$ -bounded, we see that (1.16) reduces to (1.11) for a sufficiently large  $k$ . Similarly, the coefficient  $K_{\lambda\mu}^{(k)}$  in (1.17) reduces to the classical Kostka number  $K_{\lambda\mu}$  when  $k$  is large. Our definition of the  $k$ -Young lattice and its admissible chains, combined with the experimental Pieri rules (1.2) and (1.15), yield the following corollary of Theorems 4.9 and 6.6:

*On the validity of (1.15),  $K_{\lambda,1^n}^{(k)}$  equals the number of standard  $k$ -tableaux of shape  $\mathfrak{c}(\lambda)$ , or equivalently the number of reduced expressions for  $\sigma_\lambda$ , and the coefficient  $K_{\lambda\mu}^{(k)}$  equals the number of semi-standard  $k$ -tableaux of shape  $\mathfrak{c}(\lambda)$  and evaluation  $\mu$ .*

Since (1.13) reduces to (1.16) when  $q = t = 1$ , this suggests that the positivity of  $K_{\lambda\mu}^{(k)}(q, t)$  may be accounted for by  $q, t$ -counting standard  $k$ -tableaux of shape  $\mathfrak{c}(\lambda)$ , or reduced words of  $\sigma_\lambda$ , according to a suitable statistic depending on  $\mu$ . More precisely, for  $\mathcal{T}^k(\lambda)$  the set of  $k$ -tableaux of shape  $\mathfrak{c}(\lambda)$  and  $Red(\sigma)$  the reduced words for  $\sigma$ ,

$$(1.18) \quad \begin{aligned} \mathcal{H}_\mu[X; q, t] &= \sum_{\lambda: \lambda_1 \leq k} \left( \sum_{T \in \mathcal{T}^k(\lambda)} q^{a_\mu(T)} t^{b_\mu(T)} \right) s_\lambda^{(k)}[X; t] \end{aligned}$$

$$(1.19) \quad = \sum_{\sigma \in \tilde{S}_{k+1}/S_{k+1}} \left( \sum_{w \in Red(\sigma)} q^{a_{\sigma\mu}(w)} t^{b_{\sigma\mu}(w)} \right) s_{\phi^{-1}(\sigma)}^{(k)}[X; t].$$

We should also mention that the relation in (1.17) was proven to be unitriangular [LM1] with respect to the dominance partial order “ $\succeq$ ” as well as the  $t$ -analog of this relation, given by the Hall-Littlewood polynomials corresponding to the specialization  $q = 0$  of the Macdonald polynomials:

$$(1.20) \quad H_\mu[X; 0, t] = \sum_{\substack{\lambda \in Y^k \\ \lambda \succeq \mu}} K_{\lambda\mu}^{(k)}(t) s_\lambda^{(k)}[X; t].$$

The conjecture that  $K_{\lambda\mu}^{(k)}(q, t) \in \mathbb{N}[q, t]$  implies  $K_{\lambda\mu}^{(k)}(t)$  would also have positive integer coefficients. Our work here then suggests that this positivity may be accounted for by defining the coefficients in terms of a  $k$ -charge statistic on semi-standard  $k$ -tableaux.

## 2. Definitions

A partition  $\lambda = (\lambda_1, \dots, \lambda_m)$  is a non-increasing sequence of positive integers with “degree”  $|\lambda| = \lambda_1 + \dots + \lambda_m$  and “length”  $\ell(\lambda) = m$ . Each partition  $\lambda$  has an associated Ferrers diagram with  $\lambda_i$  lattice squares in the  $i^{th}$  row, from the bottom to top, and a “conjugate” diagram  $\lambda'$  obtained by reflecting  $\lambda$  about the diagonal.  $\lambda$  is “ $k$ -bounded” if  $\lambda_1 \leq k$ . Any lattice square  $(i, j)$  in the  $i$ th row and  $j$ th column of a Ferrers diagram is called a cell. We say that  $\lambda \subseteq \mu$  when  $\lambda_i \leq \mu_i$  for all  $i$ . The “dominance order”  $\succeq$  on partitions is defined by  $\lambda \succeq \mu$  when  $\lambda_1 + \dots + \lambda_i \geq \mu_1 + \dots + \mu_i$  for all  $i$ , and  $|\lambda| = |\mu|$ . A “removable” corner of partition  $\gamma$  is a cell  $(i, j) \in \gamma$  with  $(i, j + 1), (i + 1, j) \notin \gamma$  and an “addable” corner is a square  $(i, j) \notin \gamma$  with  $(i, j - 1), (i - 1, j) \in \gamma$ .

More generally, for  $\rho \subseteq \gamma$ , the skew shape  $\gamma/\rho$  is identified with its diagram  $\{(i, j) : \rho_i < j \leq \gamma_i\}$ . The degree of a skew shape is the number of cells in its diagram. Lattice squares that do not lie in  $\gamma/\rho$  will be

simply called “squares”. We shall say that any  $c \in \rho$  lies “below”  $\gamma/\rho$ . The “hook” of any lattice square  $s \in \gamma$  is defined as the collection of cells of  $\gamma/\rho$  that lie inside the  $L$  with  $s$  as its corner. This is intended to apply to all  $s \in \gamma$  including those below  $\gamma/\rho$ . In the example below the hook of  $s = (1, 3)$  is depicted by the framed cells

(2.1)

We let  $h_s(\gamma/\rho)$  denote the number of cells in the hook of  $s$  and say that the hook of a cell or a square is  $k$ -bounded if its length is not larger than  $k$ . We are particularly interested in “ $k + 1$ -cores, partition that have no  $k + 1$ -hooks (e.g. [JK]). The “ $k + 1$ -residue” of square  $(i, j)$  is  $j - i \pmod{k + 1}$ .

A “composition”  $\alpha$  of an integer  $m$  is a vector of positive integers that sum to  $m$ . A “tableau”  $T$  of shape  $\lambda$  is a filling of  $T$  with integers that is weakly increasing in rows and strictly increasing in columns. The “evaluation” of  $T$  is given by a composition  $\alpha$  where  $\alpha_i$  is the multiplicity of  $i$  in  $T$ .

The affine symmetric group  $\tilde{S}_{k+1}$  is generated by the  $k + 1$  elements  $\hat{s}_0, \dots, \hat{s}_k$  satisfying the affine Coxeter relations:

(2.2) 
$$\hat{s}_i^2 = id, \quad \hat{s}_i \hat{s}_j = \hat{s}_j \hat{s}_i \quad (i - j \not\equiv \pm 1 \pmod{k + 1}),$$
 and 
$$\hat{s}_i \hat{s}_{i+1} \hat{s}_i = \hat{s}_{i+1} \hat{s}_i \hat{s}_{i+1}.$$

Note that  $\hat{s}_i$  is understood as  $\hat{s}_{i \pmod{k+1}}$  if  $i \geq k + 1$ . Elements of  $\tilde{S}_{k+1}$  are called affine permutations. A word  $w = i_1 i_2 \dots i_m$  in the alphabet  $\{0, 1, \dots, k\}$  corresponds to the permutation  $\sigma \in \tilde{S}_{k+1}$  if  $\sigma = \hat{s}_{i_1} \dots \hat{s}_{i_m}$ . The “length” of  $\sigma$ , denoted  $\ell(\sigma)$ , is the length of the shortest word corresponding to  $\sigma$ . Any word for  $\sigma$  with  $\ell(\sigma)$  letters is said to be “reduced”. We denote by  $Red(\sigma)$  the set of all reduced words of  $\sigma$ .

The weak order on  $\tilde{S}_{k+1}$  is defined through the following covering relations:

(2.3) 
$$\sigma <_w \tau \iff \tau = \hat{s}_i \sigma \text{ for some } i \in \{0, \dots, k\}, \text{ and } \ell(\tau) > \ell(\sigma).$$

The subgroup of  $\tilde{S}_{k+1}$  generated by the subset  $\{\hat{s}_1, \dots, \hat{s}_k\}$  is a maximal parabolic subgroup denoted by  $S_{k+1}$ . We consider the set of minimal coset representatives of  $\tilde{S}_{k+1}/S_{k+1}$ .

### 3. The $k$ -Young lattice

Let  $\mathcal{C}_{k+1}$  and  $\mathcal{P}_k$  respectively denote the collections of  $k + 1$  cores and  $k$ -bounded partitions. We start with the map

$$\mathbf{p} : \gamma \tilde{\Omega}(\lambda_1, \dots, \lambda_\ell)$$

where  $\lambda_i$  is the number of cells with a  $k$ -bounded hook in row  $i$  of  $\gamma$ . If  $\rho(\gamma)$  is the partition consisting only of the cells in  $\gamma$  whose hook lengths exceed  $k$ , then  $\mathbf{p}(\gamma) = \lambda$  is equivalently defined by letting  $\lambda_i$  denote the length of row  $i$  in the skew diagram  $\gamma/\rho(\gamma)$ . For example, with  $k = 4$ :

(3.1)

We prove that  $\mathbf{p}$  is a bijection by showing that each diagram  $\gamma/\rho(\gamma)$  can be uniquely associated to a skew diagram constructed from some  $k$ -bounded partition  $\lambda$ .

**Definition 3.1.** For any  $\lambda \in \mathcal{P}_k$ , the “ $k$ -skew diagram of  $\lambda$ ” is the diagram  $\lambda/k$  where

- (i) row  $i$  has length  $\lambda_i$  for  $i = 1, \dots, \ell(\lambda)$
- (ii) no cell of  $\lambda/k$  has hook-length exceeding  $k$
- (iii) all squares below  $\lambda/k$  have hook-length exceeding  $k$ .

The inverse of  $\mathbf{p}$  can thus be defined on any  $k$ -bounded partition  $\lambda$ , with  $\lambda/k = \gamma/\rho$ , by  $\mathbf{c}(\lambda) = \gamma$ . Note, there is an algorithm for constructing  $\lambda/k$  by attaching the row of length  $\lambda_\ell$  to the bottom of  $(\lambda_1, \dots, \lambda_{\ell-1})/k$ ,

in the leftmost position so that no hooks-lengths exceeding  $k$  are created. In (3.1), we construct  $\lambda/k = \gamma/\rho$  from  $\lambda = \mathbf{p}(\gamma)$  according to this method and thus can easily find  $\mathbf{c}(\lambda) = \gamma$ .

**Theorem 3.2.**  $\mathbf{p}$  is a bijection from  $\mathcal{C}_{k+1}$  onto  $\mathcal{P}_k$  with inverse  $\mathbf{c}$ .

The notion of  $k$ -skew diagram gives rise to an involution on  $\mathcal{P}_k$ :

**Definition 3.3.** For any  $\lambda \in \mathcal{P}_k$ , the “ $k$ -conjugate” of  $\lambda$  denoted  $\lambda^{\omega_k}$  is the  $k$ -bounded partition given by the columns of  $\lambda/k$ . Equivalently,  $\lambda^{\omega_k} = \mathbf{p}(\mathbf{c}(\lambda)')$ .

Given the  $k$ -conjugate, a partial order “ $\preceq$ ” on the collection of  $k$ -bounded partitions arises:

**Definition 3.4.** The “ $k$ -Young lattice”  $\preceq$  on partitions in  $\mathcal{P}_k$  is defined by the covering relation

$$(3.2) \quad \lambda \tilde{\Omega}_k \mu \quad \text{when} \quad \lambda \subseteq \mu \quad \text{and} \quad \lambda^{\omega_k} \subseteq \mu^{\omega_k}$$

for  $\mu, \lambda \in \mathcal{P}_k$  where  $|\mu| - |\lambda| = 1$ . See Figure 1.

The  $k$ -Young lattice generalizes the Young lattice since  $\lambda \preceq \mu$  reduces to  $\lambda \leq \mu$  when  $\mu$  is such that  $h_{(1,1)}(\mu) \leq k$ . It is also important to note that although the definition of  $\preceq$  implies:

$$\lambda \preceq \mu \implies \lambda \subseteq \mu \quad \text{and} \quad \lambda^{\omega_k} \subseteq \mu^{\omega_k},$$

the converse of this statement does not hold. For example, with  $k = 3$ ,  $\lambda = (2, 2)$  and  $\mu = (3, 2, 1, 1, 1, 1)$ , we have  $\lambda \subseteq \mu$  and  $\lambda^{\omega_k} \subseteq \mu^{\omega_k}$ , but  $\lambda \not\preceq \mu$ . This can be verified by constructing all chains using Theorem 4.1, or follows immediately from [LM2, Th. 19].

While this poset on  $k$ -bounded partitions originally arose in connection to a rule for multiplying  $k$ -Schur functions, we show that it is isomorphic to the weak order on the quotient of the affine symmetric group by a maximal parabolic subgroup. Consequently, this poset is a lattice [W] ([UI] gives a proof by identifying the  $k$ -Young lattice as a cone in a permutahedron-tiling of  $\mathbb{R}^k$ ).

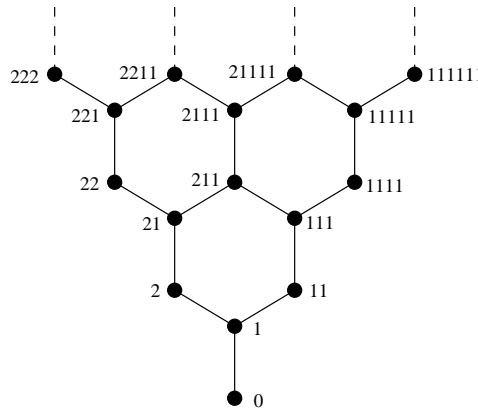

FIGURE 1. Hasse diagram of the  $k$ -Young lattice in the case  $k = 2$ .

#### 4. $k$ -Young lattice, $k + 1$ -cores, and $k$ -tableaux

Since the set of  $\mu$  such that  $\mu \supset \lambda$  and  $|\mu| = |\lambda| + 1$  consists of all partitions obtained by adding a corner to  $\lambda$ , a subset of these partitions will be the elements that cover  $\lambda$  with respect to  $\preceq$ .

**Theorem 4.1.** The order  $\preceq$  can be characterized by the covering relation

$$(4.1) \quad \lambda \tilde{\Omega}_k \mu \iff \lambda = \mu - e_r$$

where  $r$  is any row of  $\mathbf{c}(\mu)$  with a removable corner whose  $k + 1$ -residue  $i$  does not occur in a higher removable corner.



To compute the action of  $\Gamma$  on a path, we view the action of  $\mathbf{c}$  as a composition of maps on a partition – first skew the diagram and then add the squares below the skew to obtain a core.

**Theorem 4.9.**  $\Gamma$  is a bijection between  $\mathcal{D}^k(\lambda)$  and  $\mathcal{T}^k(\lambda)$  with  $\Gamma^{-1} = \bar{\Gamma}$ .

**5. The  $k$ -Young lattice and the weak order on  $\tilde{S}_{k+1}/S_{k+1}$**

The  $k + 1$ -core characterization of the  $k$ -Young lattice covering relations given in Corollary 4.4 leads to the identification of the  $k$ -Young lattice as the weak order on  $\tilde{S}_{k+1}/S_{k+1}$ . A by-product of this result is a simple bijection between reduced words and  $k$ -tableaux and one between  $k$ -bounded partitions and affine permutations in  $\tilde{S}_{k+1}/S_{k+1}$ .

**Definition 5.1.** For  $\sigma \in \tilde{S}_{k+1}$ , let  $\mathfrak{s}$  send  $\sigma$  to a  $k + 1$ -core by

$$(5.1) \quad \mathfrak{s} : \sigma = s_{i_1} \cdots s_{i_\ell} \cdot \emptyset,$$

where  $i_1 \cdots i_\ell$  is any reduced word for  $\sigma$  and  $\emptyset$  is the empty  $k + 1$ -core.

Following from the characterization of Bruhat order in terms of cores (see [L]), we are able to obtain from our  $k + 1$ -core characterization of the chains in the  $k$ -lattice that this lattice is isomorphic to the weak order on  $\tilde{S}_{k+1}/S_{k+1}$ :

**Proposition 5.2.** Let  $\sigma, \tau \in \tilde{S}_{k+1}/S_{k+1}$ , and let  $\lambda = \mathfrak{p}(\mathfrak{s}(\sigma))$  and  $\mu = \mathfrak{p}(\mathfrak{s}(\tau))$ . Then

$$(5.2) \quad \sigma \prec_w \tau \iff \lambda \tilde{\Omega}_k \mu.$$

We have seen in Theorem 4.9 that the saturated chains to shape  $\lambda$  in the  $k$ -lattice are in bijection with  $k$ -tableaux of shape  $\mathfrak{p}(\gamma)$ . On the other hand, the reduced words for  $\sigma \in \tilde{S}_{k+1}/S_{k+1}$  encode the chains to  $\sigma$ . Proposition 5.2 thus implies there is a bijection between  $k$ -tableaux of shape  $\gamma$  and the reduced words for  $\mathfrak{s}^{-1}(\gamma)$ .

**Definition 5.3.** For a  $k$ -tableau  $T$  with  $m$  letters where  $i_a$  is the  $k + 1$ -residue of the letter  $a$ , define

$$\mathfrak{w} : T \mapsto i_m \cdots i_1.$$

For  $w = i_m \cdots i_1 \in \text{Red}(\sigma)$ ,  $\mathfrak{w}^{-1}(w)$  is the tableau with letter  $\ell = 1, \dots, m$  occupying the cells of  $s_{i_\ell} \cdots s_{i_1} \cdot \emptyset / s_{i_{\ell-1}} \cdots s_{i_1} \cdot \emptyset$ .

**Example 5.4.** With  $k = 3$ :

$$T = \begin{array}{cccccc} \boxed{7} & & & & & \\ \boxed{6} & & & & & \\ \boxed{4} & \boxed{5} & \boxed{7} & & & \\ \boxed{1} & \boxed{2} & \boxed{3} & \boxed{4} & \boxed{5} & \boxed{7} \end{array} \quad \mathfrak{w} \quad \leftrightarrow \quad 1203210 \quad \text{since the 4-residues are} \quad \begin{array}{cccccc} \boxed{1} & & & & & \\ \boxed{2} & & & & & \\ \boxed{3} & \boxed{0} & \boxed{1} & & & \\ \boxed{0} & \boxed{1} & \boxed{2} & \boxed{3} & \boxed{0} & \boxed{1} \end{array}$$

**Proposition 5.5.** The map  $\mathfrak{w} : \mathcal{T}^k(\lambda) \longrightarrow \text{Red}(\sigma)$  is a bijection, where  $\sigma \in \tilde{S}_{k+1}/S_{k+1}$  is defined uniquely by  $\mathfrak{c}(\lambda) = \mathfrak{s}(\sigma)$ .

We now make use of canonical chains in the  $k$ -Young lattice to obtain a simple bijection between  $k$ -bounded partitions and permutations in  $\tilde{S}_{k+1}/S_{k+1}$ .

**Definition 5.6.** For any partition  $\lambda$ , let “ $w_\lambda$ ” be the word obtained by reading the  $k + 1$ -residues in each row of  $\lambda$ , from right to left, starting with the highest removable corner and ending in the first cell of the first row. Further, let “ $\sigma_\lambda$ ” be the affine permutation corresponding to  $w_\lambda$ .

**Example 5.7.** For  $\lambda = (3, 2, 2, 1)$  and  $k = 3$ ,  $w_\lambda = 13203210$  and  $\sigma_\lambda = \hat{s}_1 \hat{s}_3 \hat{s}_2 \hat{s}_0 \hat{s}_3 \hat{s}_2 \hat{s}_1 \hat{s}_0$  since:

$$(5.3) \quad \lambda = \begin{array}{cccc} \boxed{1} & & & \\ \boxed{2} & \boxed{3} & & \\ \boxed{3} & \boxed{0} & & \\ \boxed{0} & \boxed{1} & \boxed{2} & \end{array}$$

**Proposition 5.8.** The map  $\phi : \mathcal{P}_k \tilde{\Omega} \tilde{S}_{k+1}/S_{k+1}$  where  $\phi(\lambda) = \sigma_\lambda$  is a bijection whose inverse is  $\phi^{-1} = \mathfrak{p} \circ \mathfrak{s}$ .

### 6. Generalized $k$ -tableaux and the $k$ -Young lattice

We now introduce a set of tableaux that serve as a semi-standard version of  $k$ -tableaux.

**Definition 6.1.** Let  $\gamma$  be a  $k + 1$ -core,  $m$  be the number of  $k$ -bounded hooks of  $\gamma$ , and  $\alpha = (\alpha_1, \dots, \alpha_r)$  be a composition of  $m$ . A semi-standard  $k$ -tableau of shape  $\gamma$  and evaluation  $\alpha$  is a filling of  $\gamma$  with integers  $1, 2, \dots, r$  such that

- (i) rows are weakly increasing and columns are strictly increasing
- (ii) the collection of cells filled with letter  $i$  are labeled with exactly  $\alpha_i$  distinct  $k + 1$ -residues.

We denote the set of all semi-standard  $k$ -tableaux of shape  $\mathfrak{c}(\lambda)$  and evaluation  $\alpha$  by  $\mathcal{T}_\alpha^k(\lambda)$ . When  $\alpha = (1^m)$ , we call the  $k$ -tableaux “standard”. In this case,  $\mathcal{T}_{(1^m)}^k(\lambda) = \mathcal{T}^k(\lambda)$ .

**Example 6.2.** For  $k = 3$ ,  $\mathcal{T}_{(1,3,1,2,1,1)}^3(3, 3, 2, 1)$  of shape  $\mathfrak{c}((3, 3, 2, 1)) = (8, 5, 2, 1)$  is the set:

$$(6.1) \quad \begin{array}{|c|c|} \hline 5 \\ \hline 4 & 6 \\ \hline 2 & 3 & 4 & 4 & 6 \\ \hline 1 & 2 & 2 & 2 & 3 & 4 & 4 & 6 \\ \hline \end{array} \quad \begin{array}{|c|c|} \hline 6 \\ \hline 4 & 5 \\ \hline 2 & 3 & 4 & 4 & 5 \\ \hline 1 & 2 & 2 & 2 & 3 & 4 & 4 & 5 \\ \hline \end{array} \quad \begin{array}{|c|c|} \hline 4 \\ \hline 3 & 6 \\ \hline 2 & 4 & 4 & 5 & 6 \\ \hline 1 & 2 & 2 & 2 & 4 & 4 & 5 & 6 \\ \hline \end{array}$$

It is known that there are no semi-standard tableaux of shape  $\lambda$  and evaluation  $\mu$  when  $\lambda \not\geq \mu$  in dominance order. We have found that this is also true for the  $k$ -tableaux.

**Theorem 6.3.** *There are no semi-standard  $k$ -tableaux in  $\mathcal{T}_\mu^k(\lambda)$  when  $\lambda \not\geq \mu$ . Further, there is exactly one when  $\lambda = \mu$ .*

A rule for expanding the product of a  $k$ -Schur function with the homogeneous function  $h_\ell$  (for  $\ell \leq k$ ) in terms of  $k$ -Schur functions was conjectured in [LM1]. We introduce certain sequences of partitions based on this generalized Pieri rule and show their connection to the semi-standard  $k$ -tableaux. The connection with symmetric functions is then discussed in the next section.

A pair of  $k$ -bounded partitions  $\lambda, \mu$  is “ $r$ -admissible” if and only if  $\lambda/\mu$  and  $\lambda^{\omega_k}/\mu^{\omega_k}$  are respectively horizontal and vertical  $r$ -strips. For composition  $\alpha$ , a sequence of partitions  $(\lambda^{(0)}, \lambda^{(1)}, \dots, \lambda^{(r)})$  is “ $\alpha$ -admissible” if  $\lambda^{(j)}, \lambda^{(j-1)}$  is a  $\alpha_j$ -admissible pair for all  $j$ . It turns out that any  $\alpha$ -admissible sequence must be a chain in the  $k$ -Young lattice. We are interested in the set of chains:

**Definition 6.4.** For any composition  $\alpha$ , let

$$\mathcal{D}_\alpha^k(\lambda) = \left\{ (\emptyset = \lambda^{(0)}, \dots, \lambda^{(r)} = \lambda) \text{ that are } \alpha\text{-admissible} \right\}.$$

The following maps provide a bijection between the chains in  $\mathcal{D}_\alpha^k(\lambda)$  and the tableaux in  $\mathcal{T}_\alpha^k(\lambda)$ .

**Definition 6.5.** For any  $P = (\lambda^{(0)}, \lambda^{(1)}, \dots, \lambda^{(m)}) \in \mathcal{D}_\alpha^k(\lambda)$ , let  $\Gamma(P)$  be the tableau of shape  $\mathfrak{c}(\lambda)$  where letter  $j$  fills cells in positions  $\mathfrak{c}(\lambda^{(j)})/\mathfrak{c}(\lambda^{(j-1)})$ , for  $j = 1, \dots, m$ .

For a  $k$ -tableau  $T \in \mathcal{T}_\alpha^k(\lambda)$  with  $\alpha = (\alpha_1, \dots, \alpha_m)$ , let  $\bar{\Gamma}(T) = (\lambda^{(0)}, \dots, \lambda^{(m)})$ , where  $\mathfrak{c}(\lambda^{(i)})$  is the shape of the tableau obtained by deleting the letters  $i + 1, \dots, m$  from  $T$ .

**Theorem 6.6.**  $\Gamma$  is a bijection between  $\mathcal{T}_\alpha^k(\lambda)$  and  $\mathcal{D}_\alpha^k(\lambda)$ , with  $\Gamma^{-1} = \bar{\Gamma}$ .

### 7. Symmetric functions and $k$ -tableaux

Refer to [M] for details on Macdonald polynomials. Here, we are interested in the study of the  $q, t$ -Kostka polynomials  $K_{\mu\lambda}(q, t) \in \mathbb{N}[q, t]$ . These polynomials arise as expansion coefficients for the Macdonald polynomials  $J_\lambda[X; q, t]$  in terms of a basis dual to the monomial basis with respect to the Hall-Littlewood scalar product. As in the introduction, we use the modification of  $J_\lambda[X; q, t]$  whose expansion coefficients in

terms of Schur functions are the  $q, t$ -Kostka coefficients:

$$(7.1) \quad H_\lambda[X; q, t] = \sum_{\mu} K_{\mu\lambda}(q, t) s_\mu[X].$$

The  $q, t$ -Kostka coefficients also have a representation theoretic interpretation [GH, H], from which they were shown to lie in  $\mathbb{N}[q, t]$ . Since  $J_\lambda[X; q, t]$  reduces to the Hall-Littlewood polynomial  $Q_\lambda[X; t]$  when  $q = 0$ , we obtain a modification of the Hall-Littlewood polynomials by taking:

$$(7.2) \quad H_\lambda[X; t] = H_\lambda[X; 0, t] = \sum_{\mu \geq \lambda} K_{\mu\lambda}(t) s_\mu[X],$$

with the coefficients  $K_{\mu\lambda}(t) \in \mathbb{N}[t]$  known as Kostka-Foulkes polynomials. We can then obtain the homogeneous symmetric functions by letting  $t = 1$ :

$$(7.3) \quad h_\lambda[X] = H_\lambda[X; 1] = \sum_{\mu \geq \lambda} K_{\mu\lambda} s_\mu[X],$$

where  $K_{\mu\lambda} \in \mathbb{N}$  are the Kostka numbers.

Recent work in the theory of symmetric functions has led to a new approach in the study of the  $q, t$ -Kostka polynomials. The underlying mechanism for this approach relies on a family of polynomials that appear to have a remarkable kinship with the classical Schur functions [LLM, LM1]. More precisely, consider the filtration  $\Lambda_t^{(1)} \subseteq \Lambda_t^{(2)} \subseteq \dots \subseteq \Lambda_t^{(\infty)} = \Lambda$ , given by linear spans of Hall-Littlewood polynomials indexed by  $k$ -bounded partitions. That is,

$$\Lambda_t^{(k)} = \mathcal{L}\{H_\lambda[X; t]\}_{\lambda; \lambda_1 \leq k}, \quad k = 1, 2, 3, \dots$$

A family of symmetric functions called the  $k$ -Schur functions,  $s_\lambda^{(k)}[X; t]$ , was introduced in [LM1] (these functions are conjectured to be precisely the polynomials defined using tableaux in [LLM]). It was shown that the  $k$ -Schur functions form a basis for  $\Lambda_t^{(k)}$  and that, for  $\lambda$  a  $k$ -bounded partition,

$$(7.4) \quad H_\lambda[X; q, t] = \sum_{\mu; \mu_1 \leq k} K_{\mu\lambda}^{(k)}(q, t) s_\mu^{(k)}[X; t], \quad K_{\mu\lambda}^{(k)}(q, t) \in \mathbb{Z}[q, t],$$

and

$$(7.5) \quad H_\lambda[X; t] = s_\lambda^{(k)}[X; t] + \sum_{\substack{\mu; \mu_1 \leq k \\ \mu >_D \lambda}} K_{\mu\lambda}^{(k)}(0, t) s_\mu^{(k)}[X; t], \quad K_{\mu\lambda}^{(k)}(0, t) \in \mathbb{Z}[t].$$

The study of the  $k$ -Schur functions is motivated in part by the conjecture that the expansion coefficients actually lie in  $\mathbb{N}[q, t]$ . That is,

$$(7.6) \quad K_{\mu\lambda}^{(k)}(q, t) \in \mathbb{N}[q, t].$$

Since it was shown that  $s_\lambda^{(k)}[X; t] = s_\lambda[X]$  for  $k$  larger than the hook-length of  $\lambda$ , this conjecture generalizes Eq. (7.1). Also, there is evidence to support that  $K_{\mu\lambda}(q, t) - K_{\mu\lambda}^{(k)}(q, t) \in \mathbb{N}[q, t]$ , suggesting that the  $k$ -Schur expansion coefficients are simpler than the  $q, t$ -Kostka polynomials.

The preceding developments on the  $k$ -lattice can be applied to the study of the generalized  $q, t$ -Kostka coefficients as follows: the  $k$ -Schur functions appear to obey a generalization of the Pieri rule on Schur functions. It was conjectured in [LLM, LM1] that for the complete symmetric function  $h_\ell[X]$ ,

$$(7.7) \quad h_\ell[X] s_\lambda^{(k)}[X; 1] = \sum_{\mu \in E_{\lambda, \ell}^{(k)}} s_\mu^{(k)}[X; 1],$$

where

$$(7.8) \quad E_{\lambda, \ell}^{(k)} = \{\mu \mid \mu/\lambda \text{ is a horizontal } \ell\text{-strip and } \mu^{\omega_k}/\lambda^{\omega_k} \text{ is a vertical } \ell\text{-strip}\}.$$

Iteration, from  $s_{\emptyset}^{(k)}[X; 1] = 1$ , then yields that the expansion of  $h_{\lambda_1}[X]h_{\lambda_2}[X] \cdots$  satisfies

$$(7.9) \quad h_{\lambda}[X] = \sum_{\mu} K_{\mu\lambda}^{(k)} s_{\mu}^{(k)}[X; 1],$$

where  $K_{\mu\lambda}^{(k)}$  is a nonnegative integer reducing to the usual Kostka number  $K_{\mu\lambda}$  when  $k$  is large since  $s_{\lambda}^{(k)}[X; t] = s_{\lambda}[X]$  in this case. The definition of  $E_{\lambda,\ell}^{(k)}$  in the  $k$ -Pieri expansion thus reveals the motivation behind the set of chains given in Definition 6.4. This connection implies that

$$K_{\mu\lambda}^{(k)} = \text{the number of chains of the } k\text{-lattice in } \mathcal{D}_{\lambda}^k(\mu).$$

Equivalently, using the bijection between paths in  $\mathcal{D}_{\lambda}^k(\mu)$  and  $\mathcal{T}_{\lambda}^k(\mu)$  given in Theorem 6.6, we have

$$K_{\mu\lambda}^{(k)} = \text{the number of } k\text{-tableaux of shape } \mathfrak{c}(\mu) \text{ and evaluation } \lambda.$$

Although this combinatorial interpretation relies on the conjectured Pieri rule (7.7), it was proven in [LM1] that the  $k$ -Schur functions are unitriangularly related to the homogeneous symmetric functions. That is,  $K_{\lambda\mu}^{(k)} = 0$  when  $\mu \not\triangleright \lambda$  and  $K_{\lambda\lambda}^{(k)} = 1$ . Therefore, Theorem 6.3 implies that the number of  $k$ -tableaux does correspond to  $K_{\lambda\mu}^{(k)}$  in these cases.

More generally, note that letting  $q = 0$  in Eq. (7.6) gives that the coefficients in Hall-Littlewood expansion Eq. (7.5) satisfy  $K_{\mu\lambda}^{(k)}(0, t) \in \mathbb{N}[t]$ . However, since  $H_{\lambda}[X; 1] = h_{\lambda}[X]$ , we have that  $K_{\mu\lambda}^{(k)}(0, 1) = K_{\mu\lambda}^{(k)}$  from Eq. (7.9). Therefore, since it appears that  $K_{\mu\lambda}^{(k)}$  counts the number of semi-standard  $k$ -tableaux in  $\mathcal{T}_{\lambda}^k(\mu)$ , it is suggested that there exists a  $t$ -statistic on such  $k$ -tableaux giving a combinatorial interpretation for the generalized Kostka-Foulkes  $K_{\mu\lambda}^{(k)}(0, t)$ .

Alternatively,  $H_{\lambda}[X; 1, 1] = h_{1^n}[X]$  for  $\lambda \vdash n$  implies that  $K_{\mu\lambda}^{(k)}(1, 1) = K_{\mu 1^n}^{(k)}$  by Eq. (7.9). This lends support to the idea that a  $q, t$ -statistic on the standard  $k$ -tableaux that would account for the apparently positive coefficients  $K_{\mu\lambda}^{(k)}(q, t)$  in Eq. (7.6). That is,

$$K_{\mu\lambda}^{(k)}(1, 1) = \text{the number of standard } k\text{-tableaux of shape } \mathfrak{c}(\mu).$$

Equivalently, our bijection between affine permutations and standard  $k$ -tableaux suggests there may be a  $q, t$ -statistic on reduced words that would account for the positivity:

$$K_{\mu\lambda}^{(k)}(1, 1) = \text{the number of reduced words of } \sigma_{\mu} \in \tilde{S}_{k+1}/S_{k+1}.$$

**Acknowledgments.** *We would like to thank Michelle Wachs for helpful and revealing correspondence, and Ira Gessel for his tableaux macros.*

### References

- [BB] A. Björner and F. Brenti, *Affine permutations of type A*, Electron. J. Combinat. **3** (2), #R18 (1996).
- [DJKMO] E. Date, M. Jimbo, A. Kuniba, T. Miwa and M. Okado, *Paths, Maya diagrams, and representations of  $\widehat{\mathfrak{sl}}(r, C)$* , Adv. Stud. Pure Math. **19** (1989), 149-191.
- [GH] A. M. Garsia and M. Haiman, *A graded representation module for Macdonald's polynomials*, Proc. Natl. Acad. Sci. USA **90** (1993), 3607-3610.
- [H] M. Haiman, *Hilbert schemes, polygraphs, and the Macdonald positivity conjecture*, J. Am. Math. Soc. **14** (2001), 941-1006.
- [JK] G. D. James, and A. Kerber, *The Representation Theory of the Symmetric Group*, Addison-Wesley, Reading, 1981.
- [L] A. Lascoux, *Ordering the affine symmetric group*, in Algebraic Combinatorics and Applications (Gossweinstein, 1999), 219-231, Springer, Berlin, 2001.
- [LLM] L. Lapointe, A. Lascoux, and J. Morse, *Tableau atoms and a new Macdonald positivity conjecture*, Duke Math. J. **116** (2003), 103-146.



- [LM0] L. Lapointe, and J. Morse, *Tableaux statistics for 2 part Macdonald polynomials*, in Algebraic Combinatorics and Quantum Groups, N. Jing, Ed., World Scientific, Singapour, 2003.
- [LM1] L. Lapointe, and J. Morse, *Schur function analogs for a filtration of the symmetric function space*, J. Comb. Th. A **101/2** (2003), 191–22 .
- [LM2] L. Lapointe, and J. Morse, *Weak subposets of Young’s lattice, their order ideals  $L^k(m, n)$ , and unimodality conjectures*, to be published in Annals of Combinatorics.
- [LMW] L. Lapointe, J. Morse, and M. Wachs, *Type-A affine Weyl group and the  $k$ -Schur functions*, in preparation.
- [M] I. G. Macdonald, *Symmetric Functions and Hall Polynomials*, 2nd edition, Clarendon Press, Oxford, 1995.
- [MM] K.C. Misra and T. Miwa, *Crystal base of the basic representation of  $U_q(\widehat{sl}_n)$* , Commun. Math. Phys., **134** (1990), 79–88.
- [Ro] G. DE B. ROBINSON, *Representation theory of the symmetric group*, Edimburgh, 1961.
- [U] A. Ulyanov, *Partitions with bounded part size and permutahedral tilings*, unpublished article.
- [W] D. Waugh, *Upper bounds in affine Weyl groups under the weak order*, Order **16** (1999), 77–87.

INSTITUTO DE MATEMÁTICA Y FÍSICA, UNIVERSIDAD DE TALCA, CASILLA 747, TALCA, CHILE  
*E-mail address:* lapointe@inst-mat.otalca.cl

DEPARTMENT OF MATHEMATICS, UNIVERSITY OF MIAMI, CORAL GABLES, FL 33124  
*E-mail address:* morsej@math.miami.edu





## Affine Weyl groups in $K$ -theory and representation theory

Cristian Lenart and Alexander Postnikov

**Abstract.** We present a simple combinatorial model for the characters of the irreducible representations of complex semisimple Lie groups and, more generally, for Demazure characters. On the other hand, we give an explicit combinatorial Chevalley-type formula for the  $T$ -equivariant  $K$ -theory of generalized flag manifolds  $G/B$ . The construction is given in terms of alcove paths, which correspond to decompositions of affine Weyl group elements, and saturated chains in the Bruhat order on the (nonaffine) Weyl group. A key ingredient is a certain  $R$ -matrix, that is, a collection of operators satisfying the Yang-Baxter equation. Our model has several advantages over the Littelmann path model and the LS-galleries of Gaussent and Littelmann. The relationship between our model and the latter ones is yet to be explored.

**Résumé.** Nous présentons un modèle combinatoire simple pour les caractères des représentations d'un groupe de Lie complexe semisimple et, en général, pour les caractères de Demazure. D'autre part, nous présentons une généralisation combinatoire de la formule de Chevalley pour la  $K$ -théorie équivariante des variétés de drapeaux  $G/B$ . Notre construction est en termes de chemins sur les alcôves déterminées par le groupe de Weyl affine (qui correspondent aux décompositions réduites dans ce groupe) et de chemins saturés sur le groupe de Weyl (nonaffine). Un ingrédient important est une certaine  $R$ -matrice, c'est-à-dire une collection des opérateurs qui vérifient l'équation de Yang-Baxter. Notre modèle a plusieurs avantages par comparaison avec le modèle de chemins de Littelmann et les galeries LS de Gaussent et Littelmann. La relation entre notre modèle et les deux autres n'a pas encore été étudiée.

### 1. Introduction

*Littelmann paths* give a model for characters of irreducible representations  $V_\lambda$  of a semisimple Lie group  $G$ , and, more generally, for a complex symmetrizable Kac-Moody algebra. The theory extends to the characters of *Demazure modules*  $V_{\lambda,w}$ , which are  $B$ -modules. Littelmann [Li1, Li2] showed that the mentioned characters can be described by counting certain continuous paths in  $\mathfrak{h}_\mathbb{R}^*$ . These paths are constructed recursively, using certain operators acting on them, known as *root operators*. A special case of Littelmann

---

*Key words and phrases.* semisimple Lie group, irreducible representations, generalized flag variety, Demazure characters, Chevalley formula, equivariant  $K$ -theory, affine Weyl group, alcoves, Littelmann path model, Bruhat order, Yang-Baxter equation.

C. L. was supported by a SUNY Albany Faculty Research Award.

A. P. was supported in part by the NSF and by the Sloan Foundation.

A full-size version of the paper is available as e-print [arXiv:math.RT/0309207](https://arxiv.org/abs/math.RT/0309207).

paths are the *Lakshmibai-Seshadri paths* (L-S paths), which have been introduced before, in the context of *standard monomial theory* [LS1]. L-S paths also have a nonrecursive characterization.

A geometric application of Littelmann paths was given by Pittie and Ram [PR], who used them to derive a Chevalley-type multiplication formula in the  $T$ -equivariant  $K$ -theory of the generalized flag variety  $G/B$ . Let  $K_T(G/B)$  be the Grothendieck ring of  $T$ -equivariant coherent sheaves on  $G/B$ . According to Kostant and Kumar [KK], the ring  $K_T(G/B)$  is a free module over the representation ring  $R(T)$  of the maximal torus, with basis given by the classes  $[\mathcal{O}_w]$  of structure sheaves of Schubert varieties. Pittie and Ram showed that the basis expansion of the product of  $[\mathcal{O}_w]$  with the class  $[\mathcal{L}_\lambda]$  of a line bundle can be expressed as a sum over certain L-S paths. The Pittie-Ram formula extends the classical *Chevalley formula* [Chev] for the cohomology ring  $H^*(G/B)$ , and its special case for the cohomology of the classical flag variety  $SL_n/B$ , known as *Monk's rule*.

Let us also mention some important results related to the Pittie-Ram formula. The fact that the product in this formula expands as a nonnegative combination was also explained by Brion [Bri] and Mathieu [Mat]. Brion [Bri] noted that the special case of the Pittie-Ram formula corresponding to a fundamental weight is closely related to the multiplication of  $[\mathcal{O}_w]$  with the class of the structure sheaf of a codimension 1 Schubert variety (that is, to the hyperplane section of a Schubert variety in equivariant  $K$ -theory). The coefficients in the Pittie-Ram formula were identified as certain characters by Lakshmibai and Littelmann [LL] using geometry. Finally, Littelmann and Seshadri [LS2] showed that the Pittie-Ram formula is a consequence of standard monomial theory [LS1, Li3], and, furthermore, that it is almost equivalent to standard monomial theory.

When it comes to explicit calculations, it is often quite difficult to use the Littelmann path model, for the following reasons.

- The recursive process of constructing Littelmann paths via root operators is quite complex. On the other hand, there is no nonrecursive characterization of Littelmann paths in general, with the exception of L-S paths (see the next remark).
- L-S paths are not purely combinatorial objects, since their characterization involves rational numbers. Furthermore, their complexity is reflected in the fact that some applications (the Pittie-Ram formula, standard monomial theory [LLM]) require, in the case of nonregular weights  $\lambda$ , Deodhar's lift operators  $W/W_\lambda \tilde{\Omega} W$  from cosets modulo parabolic subgroups; these operators are defined by a nontrivial recursive procedure. The picture becomes even more complicated when, beside  $W_\lambda$ , there is another parabolic subgroup involved; this situation appears, for instance, in standard monomial theory [LLM].
- The recently defined *LS-galleries* [GL], which are closely related to the path model, are given by complicated conditions.
- L-S paths did not seem to allow an extension of the Pittie-Ram formula to the case of arbitrary weights  $\lambda$ .
- It is difficult to use L-S paths to compute hyperplane sections of Schubert varieties via Brion's result mentioned above, because the Pittie-Ram formula would have to be applied a large number of times. Essentially, this means that the Pittie-Ram formula is hard to "invert".

In this paper, we present an alternative model for both Demazure characters and Chevalley-type formulas in  $K_T(G/B)$ . This model has the following nice features.

- It is simple, nonrecursive, and purely combinatorial (no rational numbers are involved). The related computations are very explicit and straightforward, since they only involve enumerating certain saturated chains in Bruhat order.
- Deodhar's lifts from cosets modulo parabolic subgroups are not needed.
- The corresponding Chevalley-type formula is equally simple for any weight, regular or nonregular, dominant or nondominant.

- This formula is straightforward to “invert”, in order to compute hyperplane sections of Schubert varieties in  $T$ -equivariant  $K$ -theory.

Our model is based on enumerating certain *saturated chains* in the Bruhat order on the corresponding Weyl group. This enumeration is determined by an *alcove path*, which is a sequence of adjacent alcoves for the affine Weyl group of the Langland’s dual group  $G^\vee$ . Alcove paths correspond to representations of elements in the affine Weyl group as products of generators.

Our Chevalley-type formula in  $K_T(G/B)$  can be conveniently formulated in terms of a certain  $R$ -matrix, that is, in terms of a collection of operators satisfying the *Yang-Baxter equation*. We express the operator  $E^\lambda$  of multiplication by the class of a line bundle  $[\mathcal{L}_\lambda] \in K_T(G/B)$  as a composition  $R^{[\lambda]}$  of elements of the  $R$ -matrix given by an alcove path. In order to prove the formula, we simply verify that the operators  $R^{[\lambda]}$  satisfy the same commutation relations with the elementary Demazure operators  $T_i$  as the operators  $E^\lambda$ .

Currently, we are working on clarifying the relationship between the Littelmann path model and LS-galleries on the one hand, and our construction on the other hand. We are planning to describe root operators and give an explicit Littlewood-Richardson rule in terms of our model in forthcoming publications. Generalizing our construction to Kac-Moody groups is also a joint project.

We are grateful to Shrawan Kumar, V. Lakshmibai, and Andrei Zelevinsky for helpful comments.

## 2. Notation

Let  $G$  be a connected, simply connected, simple complex Lie group. Fix a Borel subgroup  $B$  and a maximal torus  $T$  such that  $G \supset B \supset T$ . Let  $\mathfrak{h}$  be the corresponding Cartan subalgebra of the Lie algebra  $\mathfrak{g}$  of  $G$ . Let  $r$  be the rank of Cartan subalgebra  $\mathfrak{h}$ . Let  $\Phi \subset \mathfrak{h}^*$  be the corresponding irreducible *root system*. Let  $\mathfrak{h}_{\mathbb{R}}^* \subset \mathfrak{h}^*$  be the real span of the roots. Let  $\Phi^+ \subset \Phi$  be the set of positive roots corresponding to our choice of  $B$ . Then  $\Phi$  is the disjoint union of  $\Phi^+$  and  $\Phi^- = -\Phi^+$ . Let  $\alpha_1, \dots, \alpha_r \in \Phi^+$  be the corresponding set of *simple roots*, which form a basis of  $\mathfrak{h}_{\mathbb{R}}^*$ . Let  $(\lambda, \mu)$  denote the scalar product on  $\mathfrak{h}_{\mathbb{R}}^*$  induced by the Killing form. Given a root  $\alpha$ , the corresponding *coroot* is  $\alpha^\vee := 2\alpha/(\alpha, \alpha)$ . The collection of coroots  $\Phi^\vee := \{\alpha^\vee : \alpha \in \Phi\}$  forms the *dual root system*.

The *Weyl group*  $W \subset \text{Aut}(\mathfrak{h}_{\mathbb{R}}^*)$  of the Lie group  $G$  is generated by the reflections  $s_\alpha : \mathfrak{h}_{\mathbb{R}}^* \rightarrow \mathfrak{h}_{\mathbb{R}}^*$ , for  $\alpha \in \Phi$ , given by  $s_\alpha : \lambda \mapsto \lambda - (\lambda, \alpha^\vee)\alpha$ . In fact, the Weyl group  $W$  is generated by *simple reflections*  $s_1, \dots, s_r$  corresponding to the simple roots  $s_i := s_{\alpha_i}$ . An expression of a Weyl group element  $w$  as a product of generators  $w = s_{i_1} \cdots s_{i_l}$  which has minimal length is called a *reduced decomposition* for  $w$ ; its length  $\ell(w) = l$  is called the

*length* of  $w$ . The Weyl group contains a unique *longest element*  $w_\circ$  with maximal length  $\ell(w_\circ) = |\Phi^+|$ . For  $u, w \in W$ , we say that  $u$  *covers*  $w$ , and write  $u \succ w$ , if  $w = us_\beta$ , for some  $\beta \in \Phi^+$ , and  $\ell(u) = \ell(w) + 1$ . The transitive closure of the relation  $\succ$  is called the *Bruhat order* on  $W$ .

The *weight lattice*  $\Lambda$  is given by  $\Lambda := \{\lambda \in \mathfrak{h}_{\mathbb{R}}^* : (\lambda, \alpha^\vee) \in \mathbb{Z} \text{ for any } \alpha \in \Phi\}$ . The weight lattice  $\Lambda$  is generated by the *fundamental weights*  $\omega_1, \dots, \omega_r$ , which are defined as the elements of the dual basis to the basis of simple coroots, i.e.,  $(\omega_i, \alpha_j^\vee) = \delta_{ij}$ . The set  $\Lambda^+$  of *dominant weights* is given by  $\Lambda^+ := \{\lambda \in \Lambda : (\lambda, \alpha^\vee) \geq 0 \text{ for any } \alpha \in \Phi^+\}$ .

Let  $\rho := \omega_1 + \cdots + \omega_r = \frac{1}{2} \sum_{\beta \in \Phi^+} \beta$ . The *height* of a coroot  $\alpha^\vee \in \Phi^\vee$  is  $(\rho, \alpha^\vee) = c_1 + \cdots + c_r$  if  $\alpha^\vee = c_1\alpha_1^\vee + \cdots + c_r\alpha_r^\vee$ . Since we assumed that  $\Phi$  is irreducible, there is a unique *highest coroot*  $\theta^\vee \in \Phi^\vee$  that has maximal height. The *dual Coxeter number* is  $h^\vee := (\rho, \theta^\vee) + 1$ .

## 3. The $K$ -theory of Generalized Flag Varieties

The *generalized flag variety*  $G/B$  is a smooth projective variety. It decomposes into a disjoint union of *Schubert cells*  $X_w^\circ := BwB/B$  indexed by elements  $w \in W$  of the Weyl group. The closures of Schubert cells  $X_w := \overline{X_w^\circ}$  are called *Schubert varieties*. Let  $\mathcal{O}_w := \mathcal{O}_{X_w}$  be the structure sheaves of Schubert varieties  $X_w$ .

The group of characters  $X = X(T)$  of the maximal torus  $T$  is isomorphic to the weight lattice  $\Lambda$ . Its group algebra  $\mathbb{Z}[X] = R(T)$  is the representation ring of  $T$ . This is generated by formal exponents  $\{x^\lambda : \lambda \in \Lambda\}$  with multiplication  $x^\lambda \cdot x^\mu := x^{\lambda+\mu}$ , i.e.,  $\mathbb{Z}[X] = \mathbb{Z}[x^{\pm\omega_1}, \dots, x^{\pm\omega_r}]$  is the algebra of Laurent polynomials in  $r$  variables. Let  $\mathcal{L}_\lambda := G \times_B \mathbb{C}_\lambda$  be the line bundle over  $G/B$  associated with the weight  $\lambda$ .

Denote by  $K_T(G/B)$  the Grothendieck ring of coherent  $T$ -equivariant sheaves on  $G/B$ . According to Kostant and Kumar [KK], the Grothendieck ring  $K_T(G/B)$  is a free  $\mathbb{Z}[X]$ -module. The classes  $[\mathcal{O}_w] \in K_T(G/B)$  of the structure sheaves  $\mathcal{O}_w$  form a  $\mathbb{Z}[X]$ -basis of  $K_T(G/B)$ . The classes  $[\mathcal{L}_\lambda] \in K_T(G/B)$  of the line bundles  $\mathcal{L}_\lambda$  span the Grothendieck ring (as a  $\mathbb{Z}[X]$ -module). The product  $[\mathcal{L}_\lambda] \cdot [\mathcal{O}_u]$  in the Grothendieck ring  $K_T(G/B)$  can be written as a finite sum

$$(3.1) \quad [\mathcal{L}_\lambda] \cdot [\mathcal{O}_u] = \sum_{w \in W, \mu \in \Lambda} c_{u,w}^{\lambda,\mu} x^\mu [\mathcal{O}_w],$$

where  $c_{u,w}^{\lambda,\mu}$  are some integer coefficients. It makes sense to call these coefficients  *$K_T$ -Chevalley coefficients*; indeed, they are related to the coefficients in Chevalley’s formula via applying the *Chern character* map to both sides of (3.1). In this paper, we present an explicit combinatorial formula for  $c_{u,w}^{\lambda,\mu}$ , see Theorems 5.1 and 6.2. We will see that  $c_{u,w}^{\lambda,\mu} = 0$  unless  $w \leq u$  in the Bruhat order, and that  $c_{u,u}^{\lambda,\mu} = \delta_{\lambda,\mu}$ .

If  $\lambda$  is a dominant weight, then we will see that all coefficients  $c_{u,w}^{\lambda,\mu}$  are nonnegative. In this case, Pittie and Ram [PR] showed that  $c_{u,w}^{\lambda,\mu}$  count certain L-S paths, cf. also Lakshmibai-Littelmann [LL] and Littelmann-Seshadri [LS2].

#### 4. Affine Weyl Groups

Let  $W_{\text{aff}}$  be the *affine Weyl group* for the Langland’s dual group  $G^\vee$ . The affine Weyl group  $W_{\text{aff}}$  is generated by the affine reflections  $s_{\alpha,k} : \mathfrak{h}_{\mathbb{R}}^* \rightarrow \mathfrak{h}_{\mathbb{R}}^*$ , for  $\alpha \in \Phi$  and  $k \in \mathbb{Z}$ , that reflect the space  $\mathfrak{h}_{\mathbb{R}}^*$  with respect to the affine hyperplanes

$$(4.1) \quad H_{\alpha,k} := \{\lambda \in \mathfrak{h}_{\mathbb{R}}^* : (\lambda, \alpha^\vee) = k\}.$$

The hyperplanes  $H_{\alpha,k}$  divide the real vector space  $\mathfrak{h}_{\mathbb{R}}^*$  into open regions, called *alcoves*. The following important property can be found, e.g., in [Hum, Chapter 4].

**Lemma 4.1.** *The affine Weyl group  $W_{\text{aff}}$  acts simply transitively on the collection of all alcoves.*

The *fundamental alcove*  $A_\circ$  is given by

$$A_\circ := \{\lambda \in \mathfrak{h}_{\mathbb{R}}^* : 0 < (\lambda, \alpha^\vee) < 1 \text{ for all } \alpha \in \Phi^+\}.$$

Lemma 4.1 implies that, for any alcove  $A$ , there exists a unique element  $v_A$  of the affine Weyl group  $W_{\text{aff}}$  such that  $v_A(A_\circ) = A$ . Hence the map  $A \mapsto v_A$  is a one-to-one correspondence between alcoves and elements of the affine Weyl group.

Recall that  $\theta^\vee \in \Phi^\vee$  is the highest coroot. Let  $\theta \in \Phi^+$  be the corresponding root, and let  $\alpha_\circ := -\theta$ . The fundamental alcove  $A_\circ$  is, in fact, the simplex given by

$$(4.2) \quad A_\circ = \{\lambda \in \mathfrak{h}_{\mathbb{R}}^* : 0 < (\lambda, \alpha_i^\vee) \text{ for } i = 1, \dots, r, \text{ and } (\lambda, \theta^\vee) < 1\},$$

Lemma 4.1 also implies that the affine Weyl group is generated by the set of reflections  $s_0, s_1, \dots, s_r$  with respect to the walls of the fundamental alcove  $A_\circ$ , where  $s_0 := s_{\alpha_\circ, -1}$  and  $s_1, \dots, s_r \in W$  are the simple reflections  $s_i = s_{\alpha_i, 0}$ . As before, a decomposition  $v = s_{i_1} \cdots s_{i_l} \in W_{\text{aff}}$  is called *reduced* if it has minimal length; its length  $\ell(v) = l$  is called the length of  $v$ .

We say that two alcoves  $A$  and  $B$  are *adjacent* if  $B$  is obtained by an affine reflection of  $A$  with respect to one of its walls. In other words, two alcoves are adjacent if they are distinct and have a common wall.

For a pair of adjacent alcoves, let us write  $A \xrightarrow{\beta} B$  if the common wall of  $A$  and  $B$  is of the form  $H_{\beta,k}$

and the root  $\beta \in \Phi$  points in the direction from  $A$  to  $B$ . By definition, all alcoves that are adjacent to the fundamental alcove  $A_o$  are obtained from  $A_o$  by the reflections  $s_0, \dots, s_r$ , and  $A_o \xrightarrow{-\alpha_i} s_i(A_o)$ .

**Definition 4.2.** An *alcove path* is a sequence of alcoves  $(A_0, A_1, \dots, A_l)$  such that  $A_{j-1}$  and  $A_j$  are adjacent, for  $j = 1, \dots, l$ . Let us say that an alcove path is *reduced* if it has minimal length  $l$  among all alcove paths from  $A_0$  to  $A_l$ .

Let  $v \mapsto \bar{v}$  be the homomorphism  $W_{\text{aff}} \tilde{\Omega} W$  defined by ignoring the affine translation. In other words,  $\bar{s}_{\alpha,k} = s_\alpha \in W$ .

The following Lemma, which is essentially well-known, summarizes some properties of decompositions in affine Weyl groups, cf. [Hum].

**Lemma 4.3.** *Let  $v$  be any element of  $W_{\text{aff}}$ , and let  $A = v(A_o)$  be the corresponding alcove. Then the decompositions  $v = s_{i_1} \cdots s_{i_l}$  of  $v$  (reduced or not) as a product of generators in  $W_{\text{aff}}$  are in one-to-one correspondence with alcove paths  $A_0 \xrightarrow{-\beta_1} A_1 \xrightarrow{-\beta_2} \cdots \xrightarrow{-\beta_l} A_l$  from the fundamental alcove  $A_0 = A_o$  to  $A_l = A$ . This correspondence is explicitly given by  $A_j = s_{i_1} \cdots s_{i_j}(A_o)$ , for  $j = 0, \dots, l$ ; and the roots  $\beta_1, \dots, \beta_l$  are given by*

$$(4.3) \quad \beta_1 = \alpha_{i_1}, \beta_2 = \bar{s}_{i_1}(\alpha_{i_2}), \beta_3 = \bar{s}_{i_1} \bar{s}_{i_2}(\alpha_{i_3}), \dots, \beta_l = \bar{s}_{i_1} \cdots \bar{s}_{i_{l-1}}(\alpha_{i_l}).$$

Let  $r_j \in W_{\text{aff}}$  denote the affine reflection with respect to the common wall of the alcoves  $A_{j-1}$  and  $A_j$ , for  $j = 1, \dots, l$ . Then the affine reflections  $r_1, \dots, r_l$  are given by

$$(4.4) \quad r_1 = s_{i_1}, r_2 = s_{i_1} s_{i_2} s_{i_1}, r_3 = s_{i_1} s_{i_2} s_{i_3} s_{i_2} s_{i_1}, \dots, r_l = s_{i_1} \cdots s_{i_r} \cdots s_{i_1}.$$

We have  $\bar{r}_i = s_{\beta_i}$  and  $v = s_{i_1} \cdots s_{i_l} = r_l \cdots r_1$ .

The affine translations by weights preserve the set of affine hyperplanes  $H_{\alpha,k}$ , and map alcoves to alcoves. For  $\lambda \in \Lambda$ , let  $A_\lambda = A_o + \lambda$  be the alcove obtained by the affine translation of the fundamental alcove  $A_o$  by the vector  $\lambda$ . Let  $v_\lambda = v_{A_\lambda}$  be the corresponding element of  $W_{\text{aff}}$ , i.e.,  $v_\lambda$  is defined by  $v_\lambda(A_o) = A_\lambda$ . Note that  $v_\lambda$  may not be an affine translation, although it translates the alcove  $A_o$ .

**Definition 4.4.** Let  $\lambda$  be a weight, and let  $v_{-\lambda} = s_{i_1} \cdots s_{i_l}$  be any decomposition, reduced or not, of  $v_{-\lambda}$  as a product of generators of  $W_{\text{aff}}$ . Let  $r_1, \dots, r_l \in W_{\text{aff}}$  be the affine reflections given by (4.4), and let  $\beta_1, \dots, \beta_l$  be the roots given by (4.3). Thus  $\bar{r}_i = s_{\beta_i}$ . We say that the sequence  $(r_1, \dots, r_l)$  is the  $\lambda$ -chain of reflections and the sequence  $(\beta_1, \dots, \beta_l)$  is the  $\lambda$ -chain of roots associated with the decomposition  $v_{-\lambda} = s_{i_1} \cdots s_{i_l}$ .

Equivalently, a sequence of roots  $(\beta_1, \dots, \beta_l)$  is a  $\lambda$ -chain of roots if there is an alcove path  $A_0 \xrightarrow{-\beta_1} \cdots \xrightarrow{-\beta_l} A_l$ . By Lemma 4.3, the elements of the corresponding  $\lambda$ -chain of reflections are the affine reflections  $r_j$  with respect to the common walls of the alcoves  $A_{j-1}$  and  $A_j$ , for  $j = 1, \dots, l$ .

Finally, we say that a  $\lambda$ -chain is *reduced* if it is associated with a reduced decomposition of  $v_{-\lambda}$ .

### 5. The $K_T$ -Chevalley Formula

We can formulate our main result as follows.

**Theorem 5.1.** *Fix any weight  $\lambda$ . Let  $(r_1, \dots, r_l)$  and  $(\beta_1, \dots, \beta_l)$  be the  $\lambda$ -chain of reflections and the  $\lambda$ -chain of roots associated with a decomposition  $v_{-\lambda} = s_{i_1} \cdots s_{i_l} \in W_{\text{aff}}$ , which may or may not be reduced. Let  $u, w \in W$ , and  $\mu \in \Lambda$ . Then the  $K_T$ -Chevalley coefficient  $c_{u,w}^{\lambda,\mu}$ , i.e., the coefficient of  $x^\mu [\mathcal{O}_w]$  in the expansion of the product  $[\mathcal{L}_\lambda] \cdot [\mathcal{O}_u]$ , can be expressed as follows:*

$$(5.1) \quad c_{u,w}^{\lambda,\mu} = \sum_J (-1)^{n(J)};$$

the summation ranges over all subsets  $J = \{j_1 < \cdots < j_s\}$  of  $\{1, \dots, l\}$  satisfying the following conditions:

- (a)  $u \succ u \bar{r}_{j_1} \succ u \bar{r}_{j_1} \bar{r}_{j_2} \succ \cdots \succ u \bar{r}_{j_1} \bar{r}_{j_2} \cdots \bar{r}_{j_s} = w$  is a saturated decreasing chain from  $u$  to  $w$  in the Bruhat order on the Weyl group  $W$ ;
- (b)  $-\mu = u r_{j_1} \cdots r_{j_s}(-\lambda)$ ,

where  $n(J)$  is the number of negative roots in  $\{\beta_{j_1}, \dots, \beta_{j_s}\}$ .

If  $\lambda$  is a dominant weight, then  $c_{u,w}^{\lambda,\mu}$  equals the number of subsets  $J \subseteq \{1, \dots, l\}$  that satisfy conditions (a) and (b) in Theorem 5.1.

If  $\lambda$  is an anti-dominant weight, then  $(-1)^{\ell(u)-\ell(w)} c_{u,w}^{\lambda,\mu}$  equals the number of subsets  $J \subseteq \{1, \dots, l\}$  that satisfy conditions (a) and (b) in Theorem 5.1.

In the next section, we reformulate this Theorem in a compact form and then prove it, using a certain  $R$ -matrix. In Sections 7 and 8, we give several examples that illustrate this Theorem.

Given a dominant weight  $\lambda$ , let  $V_\lambda$  denote the finite dimensional irreducible representation of the Lie group  $G$  with highest weight  $\lambda$ . For  $\lambda \in \Lambda^+$  and  $w \in W$ , the Demazure module  $V_{\lambda,w}$  is the  $B$ -module that is dual to the space of global sections of the line bundle  $\mathcal{L}_\lambda$  on the Schubert variety  $X_w$ , i.e.,  $V_{\lambda,w} = H^0(X_w, \mathcal{L}_\lambda)^*$ . The formal characters of these modules, called Demazure characters, are given by  $ch(V_{\lambda,w}) := \sum_{\mu \in \Lambda} m_{\lambda,w}(\mu) e^\mu \in \mathbb{Z}[\Lambda]$ , where  $m_{\lambda,w}(\mu)$  is the multiplicity of the weight  $\mu$  in  $V_{\lambda,w}$ . The characters of irreducible representations of  $G$  are special cases, namely  $ch(V_\lambda) = ch(V_{\lambda,w_\circ})$ . The Demazure characters are given by Demazure's character formula [Dem].

**Lemma 5.2.** (cf. Lakshmibai-Littelmann [LL], Littelmann-Seshadri [LS2].) For any  $\lambda \in \Lambda^+$  and  $u \in W$ , the Demazure character  $ch(V_{\lambda,u})$  can be expressed in terms of the  $K_T$ -Chevalley coefficients as follows:  $ch(V_{\lambda,u}) = \sum_{w \in W, \mu \in \Lambda} c_{u,w}^{\lambda,\mu} e^\mu$ .

Theorem 5.1 implies the following combinatorial model for the Demazure characters  $ch(V_{\lambda,u})$  and, in particular, for the characters  $ch(V_\lambda)$  of the irreducible representations  $V_\lambda$  of the Lie group  $G$ .

**Corollary 5.3.** Let  $\lambda$  be a dominant weight, let  $u \in W$ , and let  $v_{-\lambda} = s_{i_1} \cdots s_{i_l} \in W_{\text{aff}}$  be a reduced decomposition of  $v_{-\lambda}$ . Let  $(r_1, \dots, r_l)$  be the corresponding  $\lambda$ -chain of reflections. Then the Demazure character  $ch(V_{\lambda,u})$  is equal to the sum

$$ch(V_{\lambda,u}) = \sum_J e^{-u r_{j_1} \cdots r_{j_s}(-\lambda)}$$

over all subsets  $J = \{j_1 < \cdots < j_s\} \subset \{1, \dots, l\}$  such that

$$u \succ u \bar{r}_{j_1} \succ u \bar{r}_{j_1} \bar{r}_{j_2} \succ \cdots \succ u \bar{r}_{j_1} \bar{r}_{j_2} \cdots \bar{r}_{j_s}$$

is a saturated decreasing chain in the Bruhat order on the Weyl group  $W$ .

We can slightly simplify the formula for the characters  $ch(V_\lambda) = ch(V_{\lambda,w_\circ})$  of the irreducible representations of  $G$ , as follows.

**Corollary 5.4.** Consider the setup in Corollary 5.3. We have

$$ch(V_\lambda) = \sum_J e^{-r_{j_1} \cdots r_{j_s}(-\lambda)},$$

where the summation is over all subsets  $J = \{j_1 < \cdots < j_s\} \subset \{1, \dots, l\}$  such that

$$1 \leq \bar{r}_{j_1} \leq \bar{r}_{j_1} \bar{r}_{j_2} \leq \cdots \leq \bar{r}_{j_1} \bar{r}_{j_2} \cdots \bar{r}_{j_s}$$

is a saturated increasing chain in the Bruhat order on the Weyl group  $W$ .

In order to make our formula completely combinatorial, we present one particular choice for the  $\lambda$ -chain of reflections, which is illustrated by Example 8.1. The construction depends on the choice of a total order on the simple roots in  $\Phi$ . For simplicity, assume that  $\lambda$  is dominant. The set  $\mathcal{R} = \mathcal{R}_\lambda \subset W_{\text{aff}}$  of affine



reflections with respect to the affine hyperplanes  $H_{\alpha,k}$  that separate the alcoves  $A_\circ$  and  $A_{-\lambda}$  is given by

$$\mathcal{R} = \mathcal{R}_\lambda = \bigcup_{\alpha \in \Phi^+} \{s_{\alpha,k} : 0 \geq k > -(\lambda, \alpha^\vee)\}.$$

Let us choose a path  $\pi : [0, 1] \tilde{\Omega} \mathfrak{h}_\mathbb{R}^*$  that connects the alcoves  $A_\circ$  and  $A_{-\lambda}$ ; then let us totally order the set  $\mathcal{R}$  according to the order in which the path  $\pi$  crosses the hyperplanes  $H_{\alpha,k}$ . If the path is given by  $\pi = \pi_\varepsilon : t \mapsto -t\lambda + \varepsilon\omega_1 + \varepsilon^2\omega_2 + \dots + \varepsilon^r\omega_r$ , where  $\varepsilon$  is a sufficiently small positive constant, then the corresponding total order on  $\mathcal{R}$  can be described as follows. Let  $h : \mathcal{R} \tilde{\Omega} \mathbb{R}^{r+1}$  be the map given by

$$(5.2) \quad h : s_{\alpha,k} \mapsto (\lambda, \alpha^\vee)^{-1} (-k, (\omega_1, \alpha^\vee), \dots, (\omega_r, \alpha^\vee)),$$

for any  $s_{\alpha,k} \in \mathcal{R}$  with  $\alpha \in \Phi^+$ . The map  $h$  is injective.

**Proposition 5.5.** *Let  $\mathcal{R} = \{r_1 < r_2 < \dots < r_l\}$  be the total order on the set  $\mathcal{R}$  such that  $h(r_1) < h(r_2) < \dots < h(r_l)$  in the lexicographic order on  $\mathbb{R}^{r+1}$ . Then  $(r_1, \dots, r_l)$  is a reduced  $\lambda$ -chain of reflections.*

### 6. $K_T$ -Chevalley Formula: Operator Notation

Let us extend the ring of coefficients in  $K_T(G/B)$ , as follows. Let  $\Lambda/h^\vee := \{\lambda/h^\vee : \lambda \in \Lambda\}$ , where  $h^\vee = (\rho, \theta^\vee) + 1$  is the dual Coxeter number. Let  $\mathbb{Z}[\tilde{X}]$  be the group algebra of  $\Lambda/h^\vee$  with formal exponents  $x^{\lambda/h^\vee}$ , for  $\lambda \in \Lambda$ . And let  $\tilde{K}_T(G/B) := K_T(G/B) \otimes_{\mathbb{Z}[X]} \mathbb{Z}[\tilde{X}]$ . For  $\alpha \in \Phi^+$ , define the  $\mathbb{Z}[\tilde{X}]$ -linear Bruhat operators  $B_\alpha$  acting on  $\tilde{K}_T(G/B)$  by

$$(6.1) \quad B_\alpha : [\mathcal{O}_w] \mapsto \begin{cases} [\mathcal{O}_{ws_\alpha}] & \text{if } \ell(ws_\alpha) = \ell(w) - 1, \\ 0 & \text{otherwise.} \end{cases}$$

Also define  $B_\alpha := -B_{-\alpha}$ , for negative roots  $\alpha$ . The operators  $B_\alpha$  move Weyl group elements one step down in the Bruhat order. For a weight  $\lambda$ , define the  $\mathbb{Z}[\tilde{X}]$ -linear operators  $X^\lambda$  acting on  $\tilde{K}_T(G/B)$  by

$$(6.2) \quad X^\lambda : [\mathcal{O}_w] \mapsto x^{w(\lambda/h^\vee)}[\mathcal{O}_w].$$

Let us define operators  $R_\alpha$  by

$$(6.3) \quad R_\alpha := X^\alpha + X^{(\rho, \alpha^\vee)\alpha} B_\alpha = X^\rho (X^\alpha + B_\alpha) X^{-\rho}, \quad \text{for } \alpha \in \Phi.$$

The operators  $R_\alpha$  generalize the operators considered in [BFP]. The following claim can be proved along the lines of [BFP].

**Theorem 6.1.** *The family of operators  $R_\alpha$ ,  $\alpha \in \Phi$ , satisfies the Yang-Baxter equation (in the sense of Cherednik [Cher, Definition 2.1a]). In other words,  $R_{-\alpha} = (R_\alpha)^{-1}$ ; the operators  $R_\alpha$  and  $R_\beta$  commute whenever  $(\alpha, \beta) = 0$ ; if  $\alpha$  and  $\beta$  generate a root subsystem of type  $A_2$ , then*

$$R_\alpha R_{\alpha+\beta} R_\beta = R_\beta R_{\alpha+\beta} R_\alpha;$$

finally, there are similar relations for the other rank 2 root subsystems.

For  $\lambda \in \Lambda$ , let us define the operator  $R^{[\lambda]}$  acting on  $\tilde{K}_T(G/B)$  as

$$(6.4) \quad R^{[\lambda]} = R_{\beta_l} R_{\beta_{l-1}} \dots R_{\beta_2} R_{\beta_1},$$

where  $(\beta_1, \dots, \beta_l)$  is a  $\lambda$ -chain of roots and the  $R_\alpha$  are given by (6.3). Theorem 6.1 implies that the operator  $R^{[\lambda]}$  depends only on the weight  $\lambda$  and not on the choice of a  $\lambda$ -chain. The operator  $R^{[\lambda]}$  preserves the space  $K_T(G/B)$ .

We can formulate the equivariant  $K$ -theory Chevalley formula using the operator notation, as follows.

**Theorem 6.2.** *For any weight  $\lambda$  and any  $u \in W$ , we have*

$$[\mathcal{L}_\lambda] \cdot [\mathcal{O}_u] = R^{[\lambda]}([\mathcal{O}_u]),$$

*i.e., the operator  $R^{[\lambda]}$  acts on the space  $K_T(G/B)$  as the operator of multiplication by the class  $[\mathcal{L}_\lambda]$  of a line bundle.*

If  $\lambda$  is a dominant weight, then all roots in a reduced  $\lambda$ -chain are positive; thus the operator  $R^{[\lambda]}$  expands as a positive expression in the Bruhat operators  $B_\alpha$ ,  $\alpha \in \Phi^+$ , and the operators  $X^\mu$ . In this case, Theorem 6.2 gives a positive formula for  $[\mathcal{L}_\lambda] \cdot [\mathcal{O}_u]$ .

### 7. Examples for Type A

Suppose that  $G = SL_n$ . Then the root system  $\Phi$  is of type  $A_{n-1}$  and the Weyl group  $W$  is the symmetric group  $S_n$ . We can identify the space  $\mathfrak{h}_{\mathbb{R}}^*$  with the quotient space  $V := \mathbb{R}^n / \mathbb{R}(1, \dots, 1)$ , where  $\mathbb{R}(1, \dots, 1)$  denotes the subspace in  $\mathbb{R}^n$  spanned by the vector  $(1, \dots, 1)$ . The action of the symmetric group  $S_n$  on  $V$  is obtained from the (left)  $S_n$ -action on  $\mathbb{R}^n$  by permutation of coordinates. Let  $\varepsilon_1, \dots, \varepsilon_n \in V$  be the images of the coordinate vectors in  $\mathbb{R}^n$ . The root system  $\Phi$  can be represented as  $\Phi = \{\alpha_{ij} := \varepsilon_i - \varepsilon_j : i \neq j, 1 \leq i, j \leq n\}$ . The simple roots are  $\alpha_i = \alpha_{i, i+1}$ , for  $i = 1, \dots, n-1$ . The longest coroot is  $\theta^\vee = \alpha_{1n}^\vee$ . The fundamental weights are  $\omega_i = \varepsilon_1 + \dots + \varepsilon_i$ , for  $i = 1, \dots, n-1$ . We have  $\rho = n\varepsilon_1 + (n-1)\varepsilon_2 + \dots + 2\varepsilon_{n-1} + \varepsilon_n$ . The dual Coxeter number is  $h^\vee = (\rho, \theta^\vee) + 1 = n$ . The weight lattice is  $\Lambda = \mathbb{Z}^n / \mathbb{Z}(1, \dots, 1)$ . We use the notation  $[\lambda_1, \dots, \lambda_n]$  for a weight, as the coset of  $(\lambda_1, \dots, \lambda_n)$  in  $\mathbb{Z}^n$ .

Let  $Z \subset \Lambda$  be the set  $Z$  of central points of alcoves scaled by the factor  $h^\vee = n$ . The fundamental alcove corresponds to the point  $\rho$  in  $Z$ . Two alcoves are adjacent  $A \xrightarrow{\alpha} B$ ,  $\alpha \in \Phi$ , if and only if the corresponding elements of  $Z$  are related by  $\zeta_B - \zeta_A = \alpha$ . In this case, we write  $\zeta_A \xrightarrow{\alpha} \zeta_B$ . Thus, we have the structure of a directed graph with labeled edges on the set  $Z$ . Alcove paths correspond to paths in this graph. The set  $Z$  can be explicitly described as

$$Z = \{[\mu_1, \dots, \mu_n] \in \Lambda : \mu_1, \dots, \mu_n \text{ have distinct residues modulo } n\}.$$

For an element  $\mu = [\mu_1, \dots, \mu_n] \in Z$ , there exists an edge  $\mu \xrightarrow{\alpha_{ij}} (\mu + \alpha_{ij})$  if and only if  $\mu_i + 1 \equiv \mu_j \pmod n$ . Given a weight  $\lambda$ , the corresponding  $\lambda$ -chains are in one-to-one correspondence with directed paths in the graph  $Z$  from  $\rho$  to  $\rho - n\lambda$ .

**Example 7.1.** Suppose that  $n = 4$  and  $\lambda = \omega_2 = [1, 1, 0, 0]$ . The directed path

$$[4, 3, 2, 1] \xrightarrow{-\alpha_{23}} [4, 2, 3, 1] \xrightarrow{-\alpha_{13}} [3, 2, 4, 1] \xrightarrow{-\alpha_{24}} [3, 1, 4, 2] \xrightarrow{-\alpha_{14}} [2, 1, 4, 3].$$

from  $\rho = [4, 3, 2, 1]$  to  $\rho - n\omega_2 = [0, -1, 2, 1] = [2, 1, 4, 3]$  produces the  $\omega_2$ -chain  $(\alpha_{23}, \alpha_{13}, \alpha_{24}, \alpha_{14})$ .

**Example 7.2.** For an arbitrary  $n$ , we have  $\omega_1 = \varepsilon_1 = [1, 0, \dots, 0]$ . The path

$$\begin{aligned} & [n, n-1, \dots, 1] \xrightarrow{-\alpha_{12}} [n-1, n, n-2, \dots, 1] \xrightarrow{-\alpha_{13}} [n-2, n, n-1, n-3, \dots, 1] \\ & \text{quad} \xrightarrow{-\alpha_{14}} [n-3, n, n-1, n-2, n-4, \dots, 1] \xrightarrow{-\alpha_{15}} \dots \xrightarrow{-\alpha_{1n}} [1, n, n-1, \dots, 2]. \end{aligned}$$

from  $\rho$  to  $\rho - n\omega_1$  gives the  $\omega_1$ -chain  $(\alpha_{12}, \alpha_{13}, \alpha_{14}, \dots, \alpha_{1n})$ . In general, for any  $k = 1, \dots, n$ , we have the  $\varepsilon_k$ -chain

$$(7.1) \quad (\alpha_{k, k+1}, \alpha_{k, k+2}, \dots, \alpha_{k, n}, \alpha_{k, 1}, \alpha_{k, 2}, \dots, \alpha_{k, k-1})$$

given by the corresponding path from  $\rho$  to  $\rho - n\varepsilon_k$ .

Recall that  $v_{-\lambda}$  is the unique element of  $W_{\text{aff}}$  such that  $v_{-\lambda}(A_o) = A_{-\lambda}$ . Equivalently, we can define  $v_{-\lambda}$  in terms of central points of alcoves by the condition  $v_{-\lambda}(\rho/h^\vee) = \rho/h^\vee - \lambda$ .

**Lemma 7.3.** *Suppose that  $\Phi$  is of type  $A_{n-1}$ . Then, for  $k = 1, \dots, n-1$ , the affine Weyl group element  $v_{-\omega_k}$  belongs, in fact, to  $S_n \subset W_{\text{aff}}$ . This permutation is given by*

$$v_{-\omega_k} = \begin{pmatrix} 1 & 2 & \cdots & n-k & n-k+1 & \cdots & n \\ k+1 & k+2 & \cdots & n & 1 & \cdots & k \end{pmatrix} \in S_n \subset W_{\text{aff}}.$$

Let  $R_{ij} := R_{\alpha_{ij}}$ . Theorem 6.2 implies the following statement.

**Corollary 7.4.** *For  $k = 1, \dots, n$ , the operator of multiplication by  $[\mathcal{L}_{\varepsilon_k}]$  in the Grothendieck ring  $K_T(SL_n/B)$  is given by*

$$R^{[\varepsilon_k]} = R_{k\ k-1} R_{k\ k-2} \cdots R_{k\ 1} R_{k\ n} R_{k\ n-1} \cdots R_{k\ k+1}.$$

For  $k = 1, \dots, n-1$ , the operator of multiplication by the line bundle  $[\mathcal{L}_{\omega_k}]$  corresponding to the  $k$ -th fundamental weight  $\omega_k$  is given by

$$(7.2) \quad R^{[\omega_k]} = R^{[\varepsilon_1]} \cdots R^{[\varepsilon_k]} = \prod_{i=1, \dots, k}^{\rightarrow} \prod_{j=k+1, \dots, n}^{\leftarrow} R_{ij}.$$

The combinatorial formula for multiplication by  $[\mathcal{L}_{\omega_k}]_{x=1}$  in the Grothendieck ring  $K(SL_n/B)$  that follows from formula (7.2) was originally found in [Len].

**Example 7.5.** For  $n = 3$ , Corollary 7.4 says that

$$R^{[\omega_1]} = R_{13} R_{12} \quad \text{and} \quad R^{[\omega_2]} = R_{13} R_{23}.$$

**Example 7.6.** Suppose that  $n = 3$ ,  $\lambda = \omega_1$ , and  $u = w_o = s_1 s_2 s_1 \in W$ . Let us calculate the product  $[\mathcal{L}_\lambda] \cdot [\mathcal{O}_u]$  in  $K_T(SL_n/B)$  using Theorem 5.1. The  $\omega_1$ -chain  $(\beta_1, \beta_2) = (\alpha_{12}, \alpha_{13})$  is associated with the reduced decomposition  $s_1 s_2 = v_{-\omega_1}$ . The corresponding  $\omega_1$ -chain of reflections is  $(r_1, r_2) = (s_1, s_1 s_2 s_1) = (s_{\alpha_{12}, 0}, s_{\alpha_{13}, 0})$ . Three out of four subsequences in  $(\beta_1, \beta_2)$  correspond to decreasing chains from  $w_o$ : (empty subsequence),  $(\alpha_{12})$ , and  $(\alpha_{12}, \alpha_{13})$ . Thus we have

$$[\mathcal{L}_{\omega_1}] \cdot [\mathcal{O}_{w_o}] = x^{-w_o(-\omega_1)}[\mathcal{O}_{w_o}] + x^{-w_o r_1(-\omega_1)}[\mathcal{O}_{s_1 s_2}] + x^{-w_o r_1 r_2(-\omega_1)}[\mathcal{O}_{s_2}].$$

We can write this expression as

$$[\mathcal{L}_{[1,0,0]}] \cdot [\mathcal{O}_{w_o}] = x^{[0,0,1]}[\mathcal{O}_{w_o}] + x^{[0,1,0]}[\mathcal{O}_{s_1 s_2}] + x^{[1,0,0]}[\mathcal{O}_{s_2}].$$

This gives the character of the irreducible representation  $V_{\omega_1}$ :

$$\text{ch}(V_{\omega_1}) = e^{[0,0,1]} + e^{[0,1,0]} + e^{[1,0,0]}.$$

Let us give a less trivial example.

**Example 7.7.** Suppose  $n = 3$  and  $\lambda = 2\omega_1 + \omega_2 = [3, 1, 0]$ . The path

$$\begin{aligned} [3, 2, 1] \xrightarrow{-\alpha_{12}} [2, 3, 1] \xrightarrow{-\alpha_{13}} [1, 3, 2] \xrightarrow{-\alpha_{23}} [1, 2, 3] \\ \xrightarrow{-\alpha_{13}} [0, 2, 4] \xrightarrow{-\alpha_{12}} [-1, 3, 4] \xrightarrow{-\alpha_{13}} [-2, 3, 5] \end{aligned}$$

from  $\rho = [3, 2, 1]$  to  $\rho - n\lambda = [-2, 3, 5]$  gives the  $\lambda$ -chain

$$(\beta_1, \dots, \beta_6) = (\alpha_{12}, \alpha_{13}, \alpha_{23}, \alpha_{13}, \alpha_{12}, \alpha_{13}),$$

which is associated with the reduced decomposition  $v_{-\lambda} = s_1 s_2 s_1 s_0 s_1 s_2$  in the affine Weyl group. We have

$$R^{[\lambda]} = R_{\beta_6} \cdots R_{\beta_1} = R_{13} R_{12} R_{13} R_{23} R_{13} R_{12} = R^{[\omega_1]} R^{[\omega_2]} R^{[\omega_1]}.$$

The corresponding  $\lambda$ -chain of reflections is

$$(r_1, \dots, r_6) = (s_{\alpha_{12}, 0}, s_{\alpha_{13}, 0}, s_{\alpha_{23}, 0}, s_{\alpha_{13}, -1}, s_{\alpha_{12}, -1}, s_{\alpha_{13}, -2}).$$

Theorem 5.1 says that the coefficient of  $[\mathcal{O}_w]$  in the product  $[\mathcal{L}_\lambda] \cdot [\mathcal{O}_u]$  in  $K_T(SL_n/B)$  is given by the sum over subsequences in the  $\lambda$ -chain  $(\beta_1, \dots, \beta_6)$  that correspond to saturated decreasing chains  $u \succ \dots \succ w$  in the Bruhat order on  $W = S_3$ .

Suppose that  $u = s_2s_1$ . There are five saturated chains in Bruhat order descending from  $u$ : (empty chain),  $(u \succ us_{\alpha_{12}} = s_2)$ ,  $(u \succ us_{\alpha_{13}} = s_1)$ ,  $(u \succ us_{\alpha_{12}} \succ us_{\alpha_{12}}s_{\alpha_{23}} = 1)$ ,  $(u \succ us_{\alpha_{13}} \succ us_{\alpha_{13}}s_{\alpha_{12}} = 1)$ . Thus the expansion of  $[\mathcal{L}_\lambda] \cdot [\mathcal{O}_u]$  is given by the sum over the following subsequences in the  $\lambda$ -chain  $(\beta_1, \dots, \beta_6)$ :

$$(\text{empty subsequence}), (\alpha_{12}), (\alpha_{13}), (\alpha_{12}, \alpha_{23}), (\alpha_{13}, \alpha_{12}).$$

The sequence  $(\beta_1, \dots, \beta_6)$  contains one empty subsequence, two subsequences of the form  $(\alpha_{12})$ , three subsequences of the form  $(\alpha_{13})$ , one subsequence of the form  $(\alpha_{12}, \alpha_{23})$ , and two subsequence of the form  $(\alpha_{13}, \alpha_{12})$ . Hence, we have

$$\begin{aligned} [\mathcal{L}_\lambda] \cdot [\mathcal{O}_{s_2s_1}] &= x^{-u(-\lambda)} [\mathcal{O}_{s_2s_1}] + (x^{-ur_1(-\lambda)} + x^{-ur_5(-\lambda)}) [\mathcal{O}_{s_2}] + \\ &+ (x^{-ur_2(-\lambda)} + x^{-ur_4(-\lambda)} + x^{-ur_6(-\lambda)}) [\mathcal{O}_{s_1}] + \\ &+ x^{-ur_1r_3(-\lambda)} [\mathcal{O}_1] + (x^{-ur_2r_5(-\lambda)} + x^{-ur_4r_5(-\lambda)}) [\mathcal{O}_1]. \end{aligned}$$

We can explicitly write this expression as

$$\begin{aligned} [\mathcal{L}_{[3,1,0]}] \cdot [\mathcal{O}_{s_2s_1}] &= x^{[1,0,3]} [\mathcal{O}_{s_2s_1}] + (x^{[3,0,1]} + x^{[2,0,2]}) [\mathcal{O}_{s_2}] + \\ &+ (x^{[1,3,0]} + x^{[1,2,1]} + x^{[1,1,2]}) [\mathcal{O}_{s_1}] \\ &+ x^{[3,1,0]} [\mathcal{O}_1] + (x^{[2,2,0]} + x^{[2,1,1]}) [\mathcal{O}_1]. \end{aligned}$$

The Demazure character  $ch(V_{\lambda,u})$  is obtained from the right-hand side of this expression by replacing each term  $x^\mu[\mathcal{O}_w]$  with  $e^\mu$ :

$$\begin{aligned} ch(V_{[3,1,0],s_2s_1}) &= e^{[1,0,3]} + e^{[3,0,1]} + e^{[2,0,2]} \\ &+ e^{[1,3,0]} + e^{[1,2,1]} + e^{[1,1,2]} \\ &+ e^{[3,1,0]} + e^{[2,2,0]} + e^{[2,1,1]}. \end{aligned}$$

## 8. Examples for Other Types

For root systems of other types, we can use the explicit construction of the  $\lambda$ -chain of reflections  $(r_1, \dots, r_l)$  given by Proposition 5.5.

**Example 8.1.** Suppose that the root system  $\Phi$  is of type  $G_2$ . Let us find  $\lambda$ -chains for  $\lambda = \omega_1$  and  $\lambda = \omega_2$  using Proposition 5.5. The positive roots are  $\gamma_1 = \alpha_1$ ,  $\gamma_2 = 3\alpha_1 + \alpha_2$ ,  $\gamma_3 = 2\alpha_1 + \alpha_2$ ,  $\gamma_4 = 3\alpha_1 + 2\alpha_2$ ,  $\gamma_5 = \alpha_1 + \alpha_2$ ,  $\gamma_6 = \alpha_2$ . The corresponding coroots are  $\gamma_1^\vee = \alpha_1^\vee$ ,  $\gamma_2^\vee = \alpha_1^\vee + \alpha_2^\vee$ ,  $\gamma_3^\vee = 2\alpha_1^\vee + 3\alpha_2^\vee$ ,  $\gamma_4^\vee = \alpha_1^\vee + 2\alpha_2^\vee$ ,  $\gamma_5^\vee = \alpha_1^\vee + 3\alpha_2^\vee$ ,  $\gamma_6^\vee = \alpha_2^\vee$ .

Suppose that  $\lambda = \omega_1$ . The set  $\mathcal{R}_{\omega_1}$  of affine reflections with respect to the hyperplanes separating the alcoves  $A_o$  and  $A_{-\omega_1}$  is

$$\mathcal{R}_{\omega_1} = \{s_{\gamma_1,0}, s_{\gamma_2,0}, s_{\gamma_3,0}, s_{\gamma_3,-1}, s_{\gamma_4,0}, s_{\gamma_5,0}\}.$$

The map  $h : \mathcal{R}_{\omega_1} \tilde{\Omega} \mathbb{R}^{r+1}$  given by (5.2) sends these affine reflections to the vectors

$$(0, 1, 0), (0, 1, 1), (0, 1, \frac{3}{2}), (\frac{1}{2}, 1, \frac{3}{2}), (0, 1, 2), (0, 1, 3),$$

respectively. The lexicographic order on vectors in  $\mathbb{R}^3$  induces the following total order on the set  $\mathcal{R}_{\omega_1}$ :

$$s_{\gamma_1,0} < s_{\gamma_2,0} < s_{\gamma_3,0} < s_{\gamma_4,0} < s_{\gamma_5,0} < s_{\gamma_3,-1}.$$

Suppose now that  $\lambda = \omega_2$ . The set  $\mathcal{R}_{\omega_2}$  of affine reflections with respect to the hyperplanes separating  $A_\circ$  and  $A_{-\omega_2}$  is

$$\mathcal{R}_{\omega_2} = \{s_{\gamma_2,0}, s_{\gamma_3,0}, s_{\gamma_3,-1}, s_{\gamma_3,-2}, s_{\gamma_4,0}, s_{\gamma_4,-1}, s_{\gamma_5,0}, s_{\gamma_5,-1}, s_{\gamma_5,-2}, s_{\gamma_6,0}\}.$$

The map  $h : \mathcal{R}_{\omega_2} \tilde{\Omega} \mathbb{R}^{r+1}$  sends these affine reflections to the vectors

$$(0, 1, 1), (0, \frac{2}{3}, 1), (\frac{1}{3}, \frac{2}{3}, 1), (\frac{2}{3}, \frac{2}{3}, 1), (0, \frac{1}{2}, 1), (\frac{1}{2}, \frac{1}{2}, 1), \\ (0, \frac{1}{3}, 1), (\frac{1}{3}, \frac{1}{3}, 1), (\frac{2}{3}, \frac{1}{3}, 1), (0, 0, 1),$$

respectively. The lexicographic order on vectors in  $\mathbb{R}^3$  induces the following total order on  $\mathcal{R}_{\omega_2}$ :

$$s_{\gamma_6,0} < s_{\gamma_5,0} < s_{\gamma_4,0} < s_{\gamma_3,0} < s_{\gamma_2,0} \\ < s_{\gamma_5,-1} < s_{\gamma_3,-1} < s_{\gamma_4,-1} < s_{\gamma_5,-2} < s_{\gamma_3,-2}.$$

The total orders on  $\mathcal{R}_{\omega_1}$  and  $\mathcal{R}_{\omega_2}$  correspond to the  $\omega_1$ -chain  $(\gamma_1, \gamma_2, \gamma_3, \gamma_4, \gamma_5, \gamma_3)$  and the  $\omega_2$ -chain  $(\gamma_6, \gamma_5, \gamma_4, \gamma_3, \gamma_2, \gamma_5, \gamma_3, \gamma_4, \gamma_5, \gamma_3)$ . Thus the operators of multiplication by the classes  $[\mathcal{L}_{\omega_1}]$  and  $[\mathcal{L}_{\omega_2}]$  in  $K_T(G/B)$  are given by

$$R^{[\omega_1]} = R_{\gamma_3} R_{\gamma_5} R_{\gamma_4} R_{\gamma_3} R_{\gamma_2} R_{\gamma_1}, \\ R^{[\omega_2]} = R_{\gamma_3} R_{\gamma_5} R_{\gamma_4} R_{\gamma_3} R_{\gamma_5} R_{\gamma_2} R_{\gamma_3} R_{\gamma_4} R_{\gamma_5} R_{\gamma_6}.$$

By Lemma 7.3, we have  $v_{-\omega_k} \in W$  for all fundamental weights  $\omega_k$  in type  $A$ . In fact, similar a phenomenon occurs for minuscule fundamental weights in other types as well. The last two examples concern minuscule weights in types  $B$  and  $C$ . Recall that the element  $v_{-\lambda}$  is defined by the condition  $v_{-\lambda}(\rho/h^\vee) = \rho/h^\vee - \lambda$ .

**Example 8.2.** Suppose that  $\Phi$  is a root system of type  $C_r$ . This can be embedded into  $\mathbb{R}^r$  as follows:  $\Phi = \{\pm \varepsilon_i \pm \varepsilon_j, \pm 2\varepsilon_i : i \neq j\}$ , where  $\varepsilon_1, \dots, \varepsilon_r$  are the coordinate vectors in  $\mathbb{R}^r$ . The simple roots are  $\alpha_1 = \varepsilon_1 - \varepsilon_2, \alpha_2 = \varepsilon_2 - \varepsilon_3, \dots, \alpha_{r-1} = \varepsilon_{r-1} - \varepsilon_r, \alpha_r = 2\varepsilon_r$ . The Weyl group  $W$  is the semidirect product of  $S_r$  and  $(\mathbb{Z}/2\mathbb{Z})^r$ . It acts on  $\mathbb{R}^r$  by permuting the coordinates and changing their signs. The fundamental weights are  $\omega_k = \varepsilon_1 + \dots + \varepsilon_k, k = 1, \dots, r$ ; and  $\rho = (r, \dots, 1) \in \mathbb{R}^r$ . The dual Coxeter number is  $h^\vee = (\rho, \theta^\vee) + 1 = 2r$ .

Suppose that  $\lambda = \omega_1$ . Then  $\rho - h^\vee \omega_1 = (-r, r-1, r-2, \dots, 1) \in \mathbb{R}^r$ . This weight is obtained from  $\rho$  by applying the Weyl group element  $s_{2\varepsilon_1}$  that changes the sign of the first coordinate. Thus  $v_{-\omega_1} = s_{2\varepsilon_1} \in W \subset W_{\text{aff}}$ . The only reduced decomposition of this element is  $v_{-\omega_1} = s_1 \cdots s_{r-1} s_r s_{r-1} \cdots s_1$ , so  $\ell(v_{-\omega_1}) = 2r-1$ . This reduced decomposition corresponds to the  $\omega_1$ -chain

$$(\alpha_1, s_1(\alpha_2), s_1 s_2(\alpha_3), \dots, s_1 \cdots s_{r-1}(\alpha_r), \dots, s_1 \cdots s_r \cdots s_2(\alpha_1)) = \\ (\varepsilon_1 - \varepsilon_2, \varepsilon_1 - \varepsilon_3, \dots, \varepsilon_1 - \varepsilon_r, 2\varepsilon_1, \varepsilon_1 + \varepsilon_r, \dots, \varepsilon_1 + \varepsilon_3, \varepsilon_1 + \varepsilon_2),$$

cf. Definition 4.4. The operator  $R^{[\omega_1]}$  is given by

$$R^{[\omega_1]} = R_{\varepsilon_1 + \varepsilon_2} R_{\varepsilon_1 + \varepsilon_3} \cdots R_{\varepsilon_1 + \varepsilon_r} R_{2\varepsilon_1} R_{\varepsilon_1 - \varepsilon_r} \cdots R_{\varepsilon_1 - \varepsilon_3} R_{\varepsilon_1 - \varepsilon_2}.$$

**Example 8.3.** Suppose that the root system  $\Phi$  is of type  $B_r$ . This can be embedded into  $\mathbb{R}^r$  as follows:  $\Phi = \{\pm \varepsilon_i \pm \varepsilon_j, \pm \varepsilon_i : i \neq j\}$ , where  $\varepsilon_1, \dots, \varepsilon_r$  are the coordinate vectors in  $\mathbb{R}^r$ . The simple roots are  $\alpha_1 = \varepsilon_1 - \varepsilon_2, \alpha_2 = \varepsilon_2 - \varepsilon_3, \dots, \alpha_{r-1} = \varepsilon_{r-1} - \varepsilon_r, \alpha_r = \varepsilon_r$ . The Weyl group  $W$  and its action on  $\mathbb{R}^r$  are the same as in type  $C_r$ . The fundamental weights are  $\omega_k = \varepsilon_1 + \dots + \varepsilon_k, k = 1, \dots, r-1$ , and  $\omega_r = \frac{1}{2}(\varepsilon_1 + \dots + \varepsilon_r)$ ; on the other hand,  $\rho = (r - \frac{1}{2}, \dots, 1 - \frac{1}{2}) \in \mathbb{R}^r$ . The dual Coxeter number is  $h^\vee = (\rho, \theta^\vee) + 1 = 2r$ .

Suppose that  $\lambda = \omega_r$  is the last fundamental weight. Then  $\rho - h^\vee \omega_r = (-\frac{1}{2}, -1 - \frac{1}{2}, -2 - \frac{1}{2}, \dots, -r + \frac{1}{2}) \in \mathbb{R}^r$ . This weight is obtained from  $\rho$  by applying the Weyl group element  $v_{-\omega_r} \in W \subset W_{\text{aff}}$  that reverses the

order of all coordinates and changes their signs. The element  $v_{-\omega_r} \in W$  has length  $\ell(v_{-\omega_r}) = r(r+1)/2$ . One of the reduced decompositions for this element is given by

$$v_{-\omega_r} = (s_r)(s_{r-1} s_r)(s_{r-2} s_{r-1} s_r) \cdots (s_2 \cdots s_r)(s_1 \cdots s_r).$$

The associated  $\omega_r$ -chain is  $(\alpha_r, s_r(\alpha_{r-1}), s_r s_{r-1}(\alpha_r), s_r s_{r-1} s_r(\alpha_{r-2}), \dots)$ . We can explicitly find the roots in this  $\omega_r$ -chain and write the operator  $R^{[\omega_r]}$  as

$$R^{[\omega_r]} = (R_{\varepsilon_1} R_{\varepsilon_1+\varepsilon_2} R_{\varepsilon_1+\varepsilon_3} \cdots R_{\varepsilon_1+\varepsilon_r})(R_{\varepsilon_2} R_{\varepsilon_2+\varepsilon_3} R_{\varepsilon_2+\varepsilon_4} \cdots R_{\varepsilon_2+\varepsilon_r}) \cdots \\ \cdots (R_{\varepsilon_{r-2}} R_{\varepsilon_{r-2}+\varepsilon_{r-1}} R_{\varepsilon_{r-2}+\varepsilon_r})(R_{\varepsilon_{r-1}} R_{\varepsilon_{r-1}+\varepsilon_r})(R_{\varepsilon_r}).$$

### References

- [BFP] F. Brenti, S. Fomin, and A. Postnikov. Mixed Bruhat operators and Yang-Baxter equations for Weyl groups. *Internat. Math. Res. Notices*, 8:419–441, 1999.
- [Bri] M. Brion. Positivity in the Grothendieck group of complex flag varieties. *J. Algebra*, 258:137–159, 2002.
- [Cher] I. Cherednik. Quantum Knizhnik-Zamolodchikov equations and affine root systems. *Comm. Math. Phys.*, 150:109–136, 1992.
- [Chev] C. Chevalley. Sur les décompositions cellulaires des espaces  $G/B$ . In *Algebraic Groups and Generalizations: Classical Methods*, volume 56 Part 1 of *Proceedings and Symposia in Pure Mathematics*, pages 1–23. Amer. Math. Soc., 1994.
- [Dem] M. Demazure. Désingularization des variétés de Schubert. *Annales E.N.S.*, 6:53–88, 1974.
- [GL] S. Gaussent and P. Littelmann. LS-galleries, the path model and MV-cycles. [arXiv:math.RT/0307122](https://arxiv.org/abs/math/0307122).
- [Hum] J. E. Humphreys. *Reflection groups and Coxeter groups*, volume 29 of *Cambridge Studies in Advanced Mathematics*. Cambridge University Press, Cambridge, 1990.
- [KK] B. Kostant and S. Kumar.  $T$ -equivariant  $K$ -theory of generalized flag varieties. *J. Diff. Geom.*, 32:549–603, 1990.
- [LL] V. Lakshmibai and P. Littelmann. Richardson varieties and equivariant  $K$ -theory. *J. Algebra*, 260:230–260, 2003.
- [LLM] V. Lakshmibai, P. Littelmann, and P. Magyar. Standard monomial theory and applications. In *Representation theories and algebraic geometry (Montreal, PQ, 1997)*, volume 514 of *NATO Adv. Sci. Inst. Ser. C Math. Phys. Sci.*, pages 319–364. Kluwer Acad. Publ., Dordrecht, 1998.
- [LS1] V. Lakshmibai and C. S. Seshadri. Standard monomial theory. In *Proceedings of the Hyderabad Conference on Algebraic Groups (Hyderabad, 1989)*, pages 279–322, Madras, 1991. Manoj Prakashan.
- [Len] C. Lenart. A  $K$ -theory version of Monk’s formula and some related multiplication formulas. *J. Pure Appl. Algebra*, 179:137–158, 2003.
- [Li1] P. Littelmann. A Littlewood-Richardson rule for symmetrizable Kac-Moody algebras. *Invent. Math.*, 116:329–346, 1994.
- [Li2] P. Littelmann. Paths and root operators in representation theory. *Ann. of Math. (2)*, 142:499–525, 1995.
- [Li3] P. Littelmann. Contracting modules and standard monomial theory for symmetrizable Kac-Moody algebras. *J. Amer. Math. Soc.*, 11:551–567, 1998.
- [LS2] P. Littelmann and C. S. Seshadri. A Pieri-Chevalley type formula for  $K(G/B)$  and standard monomial theory. In *Studies in memory of Issai Schur (Chevaleret/Rehovot, 2000)*, volume 210 of *Progr. Math.*, pages 155–176. Birkhäuser Boston, Boston, MA, 2003.
- [Mat] O. Mathieu. Positivity of some intersections in  $K_0(G/B)$ . *J. Pure Appl. Algebra*, 152:231–243, 2000.
- [PR] H. Pittie and A. Ram. A Pieri-Chevalley formula in the  $K$ -theory of a  $G/B$ -bundle. *Electron. Res. Announc. Amer. Math. Soc.*, 5:102–107, 1999.

DEPARTMENT OF MATHEMATICS AND STATISTICS, SUNY ALBANY, NY 12222, USA  
*E-mail address:* [lenart@csc.albany.edu](mailto:lenart@csc.albany.edu)  
*URL:* <http://math.albany.edu:8000/math/pers/lenart/>

DEPARTMENT OF MATHEMATICS, M.I.T., CAMBRIDGE, MA 02139, USA  
*E-mail address:* [apost@math.mit.edu](mailto:apost@math.mit.edu)  
*URL:* <http://www-math.mit.edu/~apost/>



## Littelmann Paths for Affine Lie Algebras

Peter Magyar

**Abstract.** We give a new combinatorial model for the crystal graphs of an affine Lie algebra  $\widehat{\mathfrak{g}}$ , unifying Littelmann's path model with the Kyoto path model. The vertices of the crystal graph are represented by certain infinitely looping paths which we call skeins.

We apply this model to the case when the corresponding finite-dimensional algebra  $\mathfrak{g}$  has a minuscule representation (classical type and  $E_6, E_7$ ). We prove that the basic level-one representation of  $\widehat{\mathfrak{g}}$ , when considered as a representation of  $\mathfrak{g}$ , is an infinite tensor product of fundamental representations of  $\mathfrak{g}$ .

This is the infinite limit of a finer result: that the finite-dimensional Demazure submodules of the basic representation are finite tensor products. The corresponding Demazure characters give generalizations of the Hall-Littlewood polynomials.

This paper is an extended abstract of [Mag].

### 1. Littelmann's path model

Littelmann's combinatorial model [Lit1],[Lit2],[LLM2] for the representations of a Kac-Moody algebra  $\mathfrak{g}$  is a vast generalization of Young tableaux. Littelmann's paths and path operators give a flexible construction of the crystal graphs associated to quantum  $\mathfrak{g}$ -modules by Kashiwara [K1] and Lusztig [Lus] (see also [Jos],[HK]). We briefly sketch Littelmann's theory.

For concreteness, let  $\mathfrak{g}$  be a complex simple Lie algebra. For our purposes, we define a  $\mathfrak{g}$ -crystal as a set  $\mathcal{B}$  with a weight function,  $\text{wt} : \mathcal{B} \rightarrow \mathbb{Z}\varpi_1 \oplus \dots \oplus \mathbb{Z}\varpi_r$ , as well as partially defined crystal operators  $e_1, \dots, e_r, f_1, \dots, f_r : \mathcal{B} \rightarrow \mathcal{B}$  satisfying:

$$\text{wt}(f_i(b)) = \text{wt}(b) - \alpha_i \quad \text{and} \quad e_i(b) = b' \iff f_i(b') = b.$$

Here  $\varpi_1, \dots, \varpi_r$  are the fundamental weights and  $\alpha_1, \dots, \alpha_r$  are the roots of  $\mathfrak{g}$ . A dominant element is a  $b \in \mathcal{B}$  such that  $e_i(b)$  is not defined for any  $i$ . We say that a crystal  $\mathcal{B}$  is a model for a  $\mathfrak{g}$ -module  $V$  if the formal character of  $\mathcal{B}$  is equal to the character of  $V$ , and the dominant elements of  $\mathcal{B}$  correspond to the highest-weight vectors of  $V$ . That is:

$$\text{char}(V) = \sum_{b \in \mathcal{B}} e^{\text{wt}(b)} \quad \text{and} \quad V \cong \bigoplus_{b \in \text{dom}} V(\text{wt}(b)),$$

where the second sum is over the dominant elements of  $\mathcal{B}$ . Clearly, a  $\mathfrak{g}$ -module  $V$  is determined up to isomorphism by any model  $\mathcal{B}$ .

---

1991 *Mathematics Subject Classification.* Primary 17B10; Secondary 05E10 .

*Key words and phrases.* minuscule representation, basic representation, Demazure module, crystal graph.

This paper grew out of a joint project with V. Kreiman, V. Lakshmibai, and J. Weyman.

We construct such  $\mathfrak{g}$ -crystals  $\mathcal{B}$  consisting of polygonal paths in the vector space of weights,  $\mathfrak{h}_{\mathbb{R}}^* := \bigoplus_{i=1}^r \mathbb{R}\varpi_i$ . Specifically:

- The *elements* of  $\mathcal{B}$  are certain continuous piecewise-linear mappings  $\pi : [0, 1] \rightarrow \tilde{\Omega}\mathfrak{h}_{\mathbb{R}}^*$ , up to reparametrization, with initial point  $\pi(0) = 0$ . We use the notation  $\pi = (v_1 \star v_2 \star \cdots \star v_k)$ , where  $v_1, \dots, v_k \in \mathfrak{h}_{\mathbb{R}}^*$  are vectors, to denote the polygonal path starting at 0 and moving linearly to  $v_1$ , then to  $v_1 + v_2$ , etc.
- The *weight* of a path is its endpoint:

$$\text{wt}(\pi) := \pi(1) = v_1 + \cdots + v_k.$$

- The *crystal lowering operator*  $f_i$  is defined as follows (and there is a similar definition of the raising operator  $e_i$ ). Let  $\star$  denote the natural associative operation of concatenation of paths, and let any linear map  $w : \mathfrak{h}_{\mathbb{R}}^* \rightarrow \tilde{\Omega}\mathfrak{h}_{\mathbb{R}}^*$  act pointwise on paths:  $w(\pi) := (w(v_1) \star \cdots \star w(v_k))$ . We will divide a path  $\pi$  into three well-defined sub-paths,  $\pi = \pi_1 \star \pi_2 \star \pi_3$ , and reflect the middle piece by the simple reflection  $s_i$ :

$$f_i \pi := \pi_1 \star s_i \pi_2 \star \pi_3.$$

The pieces  $\pi_1, \pi_2, \pi_3$  are determined according to the behavior of the  $i$ -height function  $h_i(t) = h_i^\pi(t) := \langle \pi(t), \alpha_i^\vee \rangle$ . As the point  $\pi(t)$  moves along the path from  $\pi(0) = 0$  to  $\pi(1) = \text{wt}(\pi)$ , this function may attain its minimum value  $h_i(t) = M$  several times. If, after the *last* minimum point,  $h_i(t)$  never rises to the value  $M+1$ , then  $f_i \pi$  is *undefined*. Otherwise, we define  $\pi_2$  as the last sub-path of  $\pi$  on which  $M \leq h_i(t) \leq M+1$ , and  $\pi_1, \pi_3$  as the remaining initial and final pieces of  $\pi$ .

A key advantage of the path model is that the crystal operators, while complicated, are universally defined for all paths. Hence a path crystal is completely specified by giving its set of paths  $\mathcal{B}$ .

Also, the dominant elements have a neat pictorial characterization, as the paths  $\pi$  which never leave the fundamental Weyl chamber: that is,  $h_i^\pi(t) \geq 0$  for all  $t \in [0, 1]$  and all  $i = 1, \dots, r$ . For simplicity we restrict ourselves to *integral* dominant paths, meaning that all the steps are integral weights:  $v_1, \dots, v_k \in \bigoplus_{i=1}^r \mathbb{Z}\varpi_i$ . (For arbitrary dominant paths, see [Lit2].)

Littelmann's Character Theorem [Lit2] states that if  $\pi$  is any integral dominant path with weight  $\lambda$ , then the set of paths  $\mathcal{B}(\pi)$  generated from  $\pi$  by  $f_1, \dots, f_r$  is a model for the irreducible  $\mathfrak{g}$ -module  $V(\lambda)$ . (This  $\mathcal{B}(\pi)$  is also closed under  $e_1, \dots, e_r$ .) Note that we can choose *any* integral path  $\pi$  which stays within the Weyl chamber and ends at  $\lambda$ , and each such choice gives a different (but isomorphic) path crystal modelling  $V(\lambda)$ . In principle, any reasonable indexing set for a basis of  $V(\lambda)$  should be in natural bijection with  $\mathcal{B}(\pi)$  for some choice of  $\pi$ . For example, classical Young tableaux correspond to choosing the steps  $v_j$  to be coordinate vectors in  $\mathfrak{h}_{\mathbb{R}}^* \cong \mathbb{R}^n$ .

Furthermore, we have Littelmann's Product Theorem [Lit2]: if  $\pi_1, \dots, \pi_m$  are dominant integral paths of respective weight  $\lambda_1, \dots, \lambda_m$ , then  $\mathcal{B}(\pi_1) \star \cdots \star \mathcal{B}(\pi_m)$ , the set of all concatenations, is a model for the tensor product  $V(\lambda_1) \otimes \cdots \otimes V(\lambda_m)$ .

Everything we have said also holds for the corresponding affine algebra [Kac, Ch. 6 and 7]:

$$\widehat{\mathfrak{g}} = \mathfrak{g} \otimes \mathbb{C}[t, t^{-1}] \oplus \mathbb{C}K \oplus \mathbb{C}d,$$

provided we replace the roots  $\alpha_1, \dots, \alpha_r$  of  $\mathfrak{g}$  by the roots  $\alpha_0, \alpha_1, \dots, \alpha_r$  of  $\widehat{\mathfrak{g}}$ ; and the weights  $\varpi_1, \dots, \varpi_r$  of  $\mathfrak{g}$  by the weights  $\Lambda_0, \Lambda_1, \dots, \Lambda_r$  of  $\widehat{\mathfrak{g}}$ . We also replace the vector space  $\mathfrak{h}_{\mathbb{R}}^*$  by  $\widehat{\mathfrak{h}}_{\mathbb{R}}^* := \bigoplus_{i=0}^r \mathbb{R}\Lambda_i \oplus \mathbb{R}\delta$ , where  $\delta$  is the non-divisible positive imaginary root of  $\widehat{\mathfrak{g}}$ . (Indeed, Littelmann's theory works uniformly for all symmetrizable Kac-Moody algebras.) We denote representations and path crystals of  $\mathfrak{g}$  as  $V(\lambda)$  and  $\mathcal{B}$ , and the corresponding objects for  $\widehat{\mathfrak{g}}$  as  $\widehat{V}(\Lambda)$  and  $\widehat{\mathcal{B}}$ .

We can also model the affine Demazure module  $\widehat{V}_z(\Lambda) := U(\widehat{\mathfrak{n}}_+) \cdot v_{z\Lambda}$ , where  $\widehat{\mathfrak{n}}_+$  is the algebra spanned by the positive weight-spaces of  $\widehat{\mathfrak{g}}$ ,  $z \in \widehat{W}$  is a Weyl group element, and  $v_{z\Lambda}$  is a non-zero vector of extremal



weight  $z\Lambda$  in  $\widehat{V}(\Lambda)$ . Demazure modules are always finite-dimensional vector spaces. If  $z = s_{i_1} \cdots s_{i_m}$  is a reduced decomposition and  $\pi$  is an integral dominant path of weight  $\Lambda$ , we define the *Demazure path crystal*:

$$\widehat{\mathcal{B}}_z(\pi) := \{f_{i_1}^{k_1} \cdots f_{i_m}^{k_m} \pi \mid k_1, \dots, k_m \geq 0\}.$$

Because of the local nilpotence of the lowering operators, this is always a finite set.

Then the formal character of  $\widehat{\mathcal{B}}_z(\pi)$  is equal to the character of  $\widehat{V}_z(\Lambda)$ , and  $\pi$  is the unique dominant path [Lit1]. Now suppose  $z = t_{-\lambda^\vee}$ , an anti-dominant translation in  $\widehat{W}$ , so that  $\widehat{V}_{\lambda^\vee}(\Lambda) := \widehat{V}_z(\Lambda)$  is a  $\mathfrak{g}$ -submodule of  $\widehat{V}(\Lambda)$ ; and consider  $\widehat{\mathcal{B}}_{\lambda^\vee}(\pi) := \widehat{\mathcal{B}}_z(\pi)$  as a  $\mathfrak{g}$ -crystal by forgetting the action of  $f_0, e_0$  and projecting the affine weight function to  $\mathfrak{h}_{\mathbb{R}}^*$ . Then Littelmann’s Restriction Theorem [Lit2] implies that the  $\mathfrak{g}$ -crystal  $\widehat{\mathcal{B}}_{\lambda^\vee}(\pi)$  is a model for the  $\mathfrak{g}$ -module  $\widehat{V}_{\lambda^\vee}(\Lambda)$ .

### 2. The Skein model

For the case of an affine algebra  $\widehat{\mathfrak{g}}$ , we introduce a generalization of Littelmann’s model by allowing certain infinite paths.

Let us introduce a notation for a path  $\pi$  which emphasizes the vector steps going toward the endpoint  $\Lambda = \text{wt}(\pi)$  rather than away from the starting point 0. Define

$$\pi = (\star v_k \star \cdots \star v_1 \vdash \Lambda) := (v' \star v_k \star \cdots \star v_1),$$

the path with endpoint  $\Lambda$ , last step  $v_1$ , etc, and first step  $v' := \Lambda - (v_k + \cdots + v_1)$ , a makeweight to assure that the steps add up to  $\Lambda$ .

A *skein* is an infinite list:

$$\pi = (\cdots \star v_2 \star v_1 \vdash \Lambda),$$

where  $\Lambda \in \oplus_{i=0}^r \mathbb{Z}\Lambda_i$  and  $v_j \in \mathfrak{h}_{\mathbb{R}}^*$  (not  $\widehat{\mathfrak{h}}_{\mathbb{R}}^*$ ), subject to conditions (i) and (ii) below. For  $i = 0, \dots, r$  and  $k > 0$ , define:

$$h_i[k] := \langle \Lambda - (v_1 + \cdots + v_k), \alpha_i^\vee \rangle.$$

We require:

- (i) For each  $i$  and all  $k \geq 0$ , we have  $h_i[k] \geq 0$ .
- (ii) For each  $i$ , there are infinitely many  $k$  such that  $h_i[k] = 0$ .

We think of the skein  $\pi$  as a “projective limit” of the paths

$$\pi[k] := (\star v_k \star \cdots \star v_1 \vdash \Lambda) \quad \text{as } k \rightarrow \infty.$$

The conditions on  $\pi$  assure that only a finite number of steps of  $\pi$  lie outside the fundamental chamber  $\widehat{C}$ , and that  $\pi$  touches each wall of  $\widehat{C}$  infinitely many times. Note that  $\pi$  stays always at the level  $\ell = \langle \Lambda, K \rangle$ .

**Lemma 2.1.** *For a skein  $\pi$  and  $i = 0, \dots, r$ , one of the following is true:*

- (i)  $f_i(\pi[k])$  is undefined for all  $k \geq 0$ ;
- (ii) there is a unique skein  $\pi'$  such that  $\pi'[k] = f_i(\pi[k])$  for all  $k \geq 0$ .

In the second case, we define  $f_i \pi := \pi'$ .

PROOF. Recall that a path  $\pi$  is  $i$ -neutral if  $h_i^\pi(t) \geq 0$  for all  $t$  and  $h_i^\pi(1) = 0$ . For a fixed  $i$ , divide  $\pi$  into a concatenation:  $\pi = (\cdots \star \pi_2 \star \pi_1 \star \pi_0 \vdash \Lambda)$ , where each  $\pi_j$  is an  $i$ -neutral finite path except for  $\pi_0$ , which is an arbitrary finite path. Now it is clear that if  $f_i(\pi_0)$  is undefined, then (i) holds. Otherwise (ii) holds and

$$f_i \pi = (\cdots \star \pi_2 \star \pi_1 \star f_i(\pi_0) \vdash \Lambda - \alpha_i).$$

□

We can immediately carry over the definitions of the path model to skeins, including that of (Demazure) path crystals. For example, we say that  $\pi$  is an integral dominant skein if  $\pi[k]$  is integral dominant for  $k\gamma_0$ , and hence for all  $k$ . There exist integral dominant skeins of level  $\ell = 1$  only when  $\mathfrak{g}$  has a minuscule coweight. We cannot concatenate two skeins, but we can concatenate a skein  $\pi_1$  and a path  $\pi_0$ : that is,  $\pi_1 \star \pi_0 := (\pi_1 \star \pi_0 \vdash \text{wt}(\pi_1) + \text{wt}(\pi_0))$ .

**Proposition 2.2.** *For an integral dominant skein  $\pi$  of weight  $\Lambda$ , the crystal  $\hat{\mathcal{B}}(\pi)$  is a model for  $\hat{V}(\Lambda)$ , and  $\hat{\mathcal{B}}_z(\pi)$  is a model for the Demazure module  $\hat{V}_z(\Lambda)$ .*

PROOF. Given an integral dominant skein  $\pi$  and a Weyl group element  $z \in \widetilde{W}$ , we can divide  $\pi = \pi_1 \star \pi_0$  in such a way that the Demazure operator  $\hat{\mathcal{B}}_z$  acts on  $\pi$  by reflecting intervals in  $\pi_0$  rather than  $\pi_1$ . This gives an isomorphism between the Demazure crystals generated by the path  $\text{wt}(\pi_1) \star \pi_0$  and by the skein  $\pi$ :

$$\hat{\mathcal{B}}_z(\text{wt}(\pi_1) \star \pi_0) \xrightarrow{\sim} \hat{\mathcal{B}}_z(\pi_1 \star \pi_0) = \hat{\mathcal{B}}_z(\pi)$$

$$\text{wt}(\pi_1) \star \pi' \mapsto \pi_1 \star \pi'$$

This proves the assertion about Demazure modules.

Now, given an infinite chain of Weyl group elements  $z_1 < z_2 < \dots$ , we have the morphisms of  $\hat{\mathfrak{g}}$ -crystals:

$$\begin{array}{ccc} \hat{\mathcal{B}}_{z_1}(\Lambda) & \xleftarrow{\sim} & \hat{\mathcal{B}}_{z_1}(\text{wt}(\pi_1) \star \pi_0) \xrightarrow{\sim} \hat{\mathcal{B}}_{z_1}(\pi) \\ \cap & & \cap \\ \hat{\mathcal{B}}_{z_2}(\Lambda) & \xleftarrow{\sim} & \hat{\mathcal{B}}_{z_2}(\text{wt}(\pi'_1) \star \pi'_0) \xrightarrow{\sim} \hat{\mathcal{B}}_{z_2}(\pi) \\ \cap & & \cap \\ \vdots & & \vdots \\ \hat{\mathcal{B}}(\Lambda) & & \hat{\mathcal{B}}(\pi) \end{array}$$

Here  $\hat{\mathcal{B}}_z(\Lambda)$  denotes the canonical path crystal of Lakshmibai-Seshadri paths, generated from the straight-line path  $(\Lambda)$ . Since the  $\hat{\mathfrak{g}}$  crystals at the bottom are the unions of their Demazure crystals, they are isomorphic:  $\hat{\mathcal{B}}(\Lambda) \cong \hat{\mathcal{B}}(\pi)$ . □

### 3. Product theorems

As before, we let  $\hat{\mathfrak{g}}$  be the untwisted affine Kac-Moody algebra corresponding to the complex simple algebra  $\mathfrak{g}$ . The basic representation  $\hat{V}(\Lambda_0)$ , the fundamental representation corresponding to the distinguished node of the extended Dynkin diagram, is the simplest and most important  $\hat{\mathfrak{g}}$ -module (cf. [Kac, Ch. 14],[PS, Ch. 10]).

One of its remarkable properties is the Tensor Product Phenomenon. In many cases, the Demazure modules  $\hat{V}_z(\Lambda_0) \subset \hat{V}(\Lambda_0)$  are representations of the finite-dimensional algebra  $\mathfrak{g}$ , and they factor into a tensor product of many small  $\mathfrak{g}$ -modules. Hence the full  $\hat{V}(\Lambda_0)$  could be constructed by extending the  $\mathfrak{g}$ -structure on the semi-infinite tensor power  $V \otimes V \otimes \dots$  of a small  $\mathfrak{g}$ -module  $V$ .

The Kyoto school of Jimbo, Kashiwara, et al. has established this phenomenon in many cases (and for a large class of  $\hat{\mathfrak{g}}$ -modules  $\hat{V}(\Lambda)$ ) via the theory of perfect crystals [KKMMNN], [KMOTU1], [KMOTU2], [HK], [K2] a development of their earlier theory of semi-infinite paths [DJKMO]. See especially [HKKOT]. Pappas and Rapoport [PR] have given a geometric version of the phenomenon for type  $A$ : they construct a flat deformation of Schubert varieties of the affine Grassmannian into a product of finite Grassmannians.

We extend the Tensor Product Phenomenon for  $\hat{V}(\Lambda_0)$  to the non-classical types  $E_6$  and  $E_7$  by a uniform method which applies whenever  $\mathfrak{g}$  possesses a minuscule representation, or more precisely a minuscule coweight. We shall rely on a key property of such coweights which may be taken as the definition. Let  $\hat{X}$  be the extended Dynkin diagram (the diagram of  $\hat{\mathfrak{g}}$ ). A coweight  $\varpi^\vee$  of  $\mathfrak{g}$  is *minuscule* if and only if it

is a fundamental coweight  $\varpi^\vee = \varpi_i^\vee$  and there exists an automorphism  $\sigma$  of  $\hat{X}$  taking the node  $i$  to the distinguished node 0. Such automorphisms exist in types  $A, B, C, D, E_6, E_7$ .

We let  $V(\lambda)$  denote the irreducible  $\mathfrak{g}$ -module with highest weight  $\lambda$ , and  $V(\lambda)^*$  its dual module. Our main representation-theoretic result is:

**Theorem 3.1.** *Let  $\lambda^\vee$  be an element of the coroot lattice of  $\mathfrak{g}$  which is a sum:*

$$\lambda^\vee = \lambda_1^\vee + \cdots + \lambda_m^\vee,$$

where  $\lambda_1^\vee, \dots, \lambda_m^\vee$  are minuscule fundamental coweights (not necessarily distinct), with corresponding fundamental weights  $\lambda_1, \dots, \lambda_m$ .

Let  $\hat{V}_{\lambda^\vee}(\Lambda_0) \subset \hat{V}(\Lambda_0)$  be the Demazure module corresponding to the anti-dominant translation  $t_{-\lambda^\vee}$  in the affine Weyl group.

Then there is an isomorphism of  $\mathfrak{g}$ -modules:

$$\hat{V}_{\lambda^\vee}(\Lambda_0) \cong V(\lambda_1)^* \otimes \cdots \otimes V(\lambda_m)^*.$$

Now fix a minuscule coweight  $\varpi^\vee$  and its corresponding fundamental weight  $\varpi$ . Let  $N$  be the smallest positive integer such that  $N\varpi^\vee$  lies in the coroot lattice of  $\mathfrak{g}$ . Then we have the following characterization of the basic irreducible  $\hat{\mathfrak{g}}$ -module:

**Theorem 3.2.** *The tensor power  $V_N := V(\varpi)^{\otimes N}$  possesses non-zero  $\mathfrak{g}$ -invariant vectors. Fix such a vector  $v_N$ , and define the  $\mathfrak{g}$ -module  $V^{\otimes \infty}$  as the direct limit of the sequence:*

$$V_N \hookrightarrow V_N^{\otimes 2} \hookrightarrow V_N^{\otimes 3} \hookrightarrow \dots$$

where each inclusion is defined by:  $v \mapsto v_N \otimes v$ .

Then  $\hat{V}(\Lambda_0)$  is isomorphic as a  $\mathfrak{g}$ -module to  $V^{\otimes \infty}$ .

It would be interesting to define the action of the full algebra  $\hat{\mathfrak{g}}$  on  $V^{\otimes \infty}$ , and thus give a uniform “path construction” of the basic representation (cf. [DJKMO]): that is, to define the raising and lowering operators  $E_0, F_0$ , as well as the energy operator  $d$ . Combinatorial definitions of the energy for  $\mathfrak{g}$  of classical type produce generalizations of the Hall-Littlewood and Kostka-Foulkes polynomials (c.f. [Oka]), with connections to Macdonald polynomials [San], [Ion].

### 4. Crystal theorems

We prove Theorem 3 by reducing it to an identity of paths: we construct a path crystal for the affine Demazure module which is at the same time a path crystal for the tensor product.

For  $\lambda$  a dominant weight, define its dual weight  $\lambda^*$  by the dual  $\mathfrak{g}$ -module:  $V(\lambda^*) = V(\lambda)^*$ .

**Theorem 4.1.** *Let  $\lambda^\vee$  be as in Theorem 3, and let  $\mathcal{B}(\lambda)$  denote the path crystal generated by the straight-line path  $(\lambda)$ . Then the set of concatenated paths  $\Lambda_0 \star \mathcal{B}(\lambda_1^*) \star \cdots \star \mathcal{B}(\lambda_m^*)$  is a path crystal for the Demazure module  $\hat{V}_{\lambda^\vee}(\Lambda_0)$ . In fact, there is a unique  $\hat{\mathfrak{g}}$ -dominant path  $\pi$  with weight  $\Lambda_0$  such that:*

$$\hat{\mathcal{B}}_{\lambda^\vee}(\pi) = \Lambda_0 \star \mathcal{B}(\lambda_1^*) \star \cdots \star \mathcal{B}(\lambda_m^*) \text{ mod } \mathbb{R}\delta.$$

This is to be understood as an equality of sets of paths in  $\hat{\mathfrak{h}}_{\mathbb{R}}^* \text{ mod } \mathbb{R}\delta$ , and hence an isomorphism of  $\hat{\mathfrak{g}}$ -crystals.

PROOF. Let  $\sigma_j$  be the automorphism of the diagram  $\hat{X}$  corresponding to the minuscule coweight  $\lambda_j^\vee$  for  $j = 1, \dots, m$ . This also defines an automorphism of  $\hat{\mathfrak{h}}^*$  by  $\sigma(\Lambda_i) = \Lambda_{\sigma(i)}$ . We define  $\pi_m$  inductively as the last of a sequence of paths  $\pi_0, \pi_1, \dots, \pi_m$ :

$$\pi_0 := \Lambda_0, \quad \pi_j := \sigma_j^{-1}(\pi_{j-1} \star \lambda_j^*).$$

We may picture the path  $\pi_m$  as jumping from 0 up to level  $\Lambda_0$ , winding horizontally around the fundamental alcove  $A \subset \hat{\mathfrak{h}}_{\mathbb{R}}^* + \Lambda_0$ , and ending at  $\Lambda_0$ .

We prove the Theorem by showing that the Demazure operator  $\hat{\mathcal{B}}_{\lambda'} = \hat{\mathcal{B}}_{\lambda'_1} \hat{\mathcal{B}}_{\lambda'_2} \cdots \hat{\mathcal{B}}_{\lambda'_m}$  “unwinds”  $\pi_m$  starting from its endpoint. The dual weights enter because  $\lambda_j^* = -\sigma_j(\lambda_j)$ .

The key fact is that the linear mapping  $\sigma_i$  preserves the set of paths  $\mathcal{B}(\lambda_j^*)$  for all  $i, j$ . This is obvious if  $V(\lambda_j^*)$  is a minuscule representation, but the general case requires some work using results of Stembridge [Ste]. □

Theorem 3 now follows immediately. Indeed,  $s_i \Lambda_0 = \Lambda_0$  for  $i = 1, \dots, r$ , so  $f_i(\Lambda_0 \star \pi') = \Lambda_0 \star f_i(\pi')$  for any path  $\pi'$ . Thus the right-hand side of the equation in the Theorem is isomorphic as a  $\mathfrak{g}$ -crystal to  $\mathcal{B}(\lambda_1^*) \star \cdots \star \mathcal{B}(\lambda_m^*)$ , which models  $V(\lambda_1^*) \otimes \cdots \otimes V(\lambda_r^*)$ . See [GM] for methods of enumerating the paths in this crystal (and hence computing the dimension of the corresponding representation).

Theorem 4 follows as a corollary. We describe the crystal graph of the semi-infinite tensor product by the appropriate skein-crystal. We thus recover the Kyoto path model for classical  $\mathfrak{g}$ , and our results are equally valid for  $E_6, E_7$ .

**Theorem 4.2.** *Let  $\varpi^\vee, N$  be as in Theorem 4. Define the  $m$ -fold concatenation  $\mathcal{B}_m = \mathcal{B}(\varpi^*) \star \cdots \star \mathcal{B}(\varpi^*)$ . Then  $\Lambda_0 \star \mathcal{B}_N$  contains a unique  $\hat{\mathfrak{g}}$ -dominant path  $\Lambda_0 \star \pi_N$ .*

*Define the skein  $\pi := (\cdots \star \pi_N \star \pi_N \star \pi_N \vdash \Lambda_0)$ , which satisfies  $\pi \star \pi_N = \pi$ . Then the  $\hat{\mathfrak{g}}$ -crystal of  $\hat{V}(\Lambda_0)$  is given by the skein-crystal:*

$$\hat{\mathcal{B}}(\pi) = \bigcup_{m \geq 1} \pi \star \mathcal{B}_m.$$

That is,  $\hat{\mathcal{B}}(\pi)$  is the set of all semi-infinite paths which are equal to  $\pi$  except for a finite length near the end, and all of whose vector steps lie in  $\mathcal{B}(\varpi^*)$ .

### 5. Example: $E_6$

Referring to Bourbaki [Bour], we write the extended Dynkin diagram  $\hat{X} = \hat{E}_6$ :

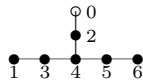

The simple roots are defined inside  $\mathbb{R}^6$  with standard basis  $\epsilon_1, \dots, \epsilon_6$ . (Our  $\epsilon_6$  is  $\frac{1}{\sqrt{3}}(-\epsilon_6 - \epsilon_7 + \epsilon_8)$  in Bourbaki’s notation.) They are:

$$\begin{aligned} \alpha_1 &= \frac{1}{2}(\epsilon_1 + \epsilon_2 + \epsilon_3 + \epsilon_4 + \epsilon_5) + \frac{\sqrt{3}}{2}\epsilon_6, & \alpha_2 &= \epsilon_1 + \epsilon_2, \\ \alpha_3 &= \epsilon_2 - \epsilon_1, & \alpha_4 &= \epsilon_3 - \epsilon_2, & \alpha_5 &= \epsilon_4 - \epsilon_3, & \alpha_6 &= \epsilon_5 - \epsilon_4. \end{aligned}$$

Since  $E_6$  is simply laced, the coroots and coweights may be identified with the roots and weights, with the natural pairing given by the standard dot product on  $\mathbb{R}^6$ .

We focus on the minuscule coweight  $\varpi_1^\vee$  corresponding to the diagram automorphism  $\sigma$  with  $\sigma(1) = 0$  and  $\sigma(0) = 6$ . In this case, the corresponding fundamental representation  $V(\varpi_1)$  is also minuscule, meaning that all of its weights are extremal weights  $\lambda \in W(E_6) \cdot \varpi_1$ . The roots  $\alpha_2, \dots, \alpha_6$  generate the root subsystem  $D_5 \subset E_6$ , and the reflection subgroup  $W(D_5) = \text{Stab}_{W(E_6)}(\varpi_1)$  acts by permuting  $\epsilon_1, \dots, \epsilon_5$  (the subgroup  $W(A_4) = S_5$ ) and by changing an even number of signs  $\pm\epsilon_1, \dots, \pm\epsilon_5$ . We have  $\dim V(\varpi_1) = |W(E_6)/W(D_5)| = 27$ . The weights are:

$$\begin{aligned} \varpi_1 &= \frac{2\sqrt{3}}{3}\epsilon_6, \\ S_5 \cdot \frac{1}{2}(-\epsilon_1 + \epsilon_2 + \epsilon_3 + \epsilon_4 + \epsilon_5) + \frac{\sqrt{3}}{6}\epsilon_6, \\ S_5 \cdot \frac{1}{2}(-\epsilon_1 - \epsilon_2 - \epsilon_3 + \epsilon_4 + \epsilon_5) + \frac{\sqrt{3}}{6}\epsilon_6, \\ &-\frac{1}{2}(\epsilon_1 + \epsilon_2 + \epsilon_3 + \epsilon_4 + \epsilon_5) + \frac{\sqrt{3}}{6}\epsilon_6, \\ &\pm S_5 \cdot \epsilon_1 - \frac{\sqrt{3}}{3}\epsilon_6. \end{aligned}$$

The lowest weight is  $-\varpi_6 = -\epsilon_5 - \frac{\sqrt{3}}{3}\epsilon_6$ , so that  $V(\varpi_1)^* = V(\varpi_6)$  and  $\varpi_1^* = \varpi_6$ .

The simplest path crystal for  $V(\varpi_1^*)$  is the set of 27 straight-line paths from 0 to the negatives of the above extremal weights:

$$\mathcal{B}(\varpi_1^*) = \{ (v) \mid v \in -W(E_6) \cdot \varpi_1 \}$$

We have  $3\varpi_1^\vee \in \oplus_{i=1}^6 \mathbb{R}\alpha_i^\vee$  the coroot lattice, so that  $N = 3$  in Theorem 4, and this  $N$  is also the order of the automorphism  $\sigma$ . The path crystal  $\mathcal{B}_3 := \mathcal{B}(\varpi_1^*) \star \mathcal{B}(\varpi_1^*) \star \mathcal{B}(\varpi_1^*)$ , the set of all 3-step walks with steps chosen from the 27 weights of  $V(\varpi_1^*)$ , is a model for  $V(\varpi_1^*)^{\otimes 3}$ .

By Theorem 5,  $\Lambda_0 \star \mathcal{B}_3$  contains a unique  $\widehat{\mathfrak{g}}$ -dominant path  $\Lambda_0 \star \pi_3$ , where

$$\pi_3 := (\varpi_6) \star (\varpi_1 - \varpi_6) \star (-\varpi_1).$$

In this case,  $\pi_3$  has the even stronger property that it is the unique  $\mathfrak{g}$ -dominant path of weight 0, so that it corresponds to the one-dimensional space of  $\mathfrak{g}$ -invariant vectors in  $V(\varpi_1^*)^{\otimes 3}$ .

Now Theorem 5 states that the affine Demazure module  $\widehat{V}_{3m\varpi_1^\vee}(\Lambda_0)$  is modelled by the  $\widehat{\mathfrak{g}}$ -path crystal:

$$\mathcal{B}_{3m} = \{ (\Lambda_0 \star v_1 \star \cdots \star v_{3m}) \mid v_j \in -W(E_6) \cdot \varpi_1 \},$$

the set of all  $3m$ -step walks in  $\Lambda_0 \oplus \mathbb{R}^6$  starting at  $\Lambda_0$ , with steps chosen from the 27 weights of  $V(\varpi_1^*)$ . This path crystal is generated from its unique  $\widehat{\mathfrak{g}}$ -dominant path  $\Lambda_0 \star \pi_3 \star \cdots \star \pi_3$ . Considering it as a  $\mathfrak{g}$ -crystal, we have  $\mathcal{B}_{3m} \cong \mathcal{B}_3^{\star m}$ , which shows that  $\widehat{V}_{3m\varpi_1^\vee}(\Lambda_0) \cong V(\varpi_1^*)^{\otimes 3m}$  as  $\mathfrak{g}$ -modules.

By Theorem 6, the  $\widehat{\mathfrak{g}}$ -crystal of the basic  $\widehat{\mathfrak{g}}$ -module  $\widehat{V}(\Lambda_0)$  is given by the set of all infinite walks (skeins) of the form:

$$\pi = \Lambda_0 \star \underbrace{\pi_3 \star \cdots \star \pi_3}_{\text{infinite}} \star v_1 \star \cdots \star v_{3m},$$

with  $m > 0$  and  $v_j \in -W(E_6) \cdot \varpi_1$ . The endpoint of such a skein is  $\text{wt}(\pi) := \Lambda_0 + v_1 + \cdots + v_{3m}$ . The crystal operators  $f_i$  are defined just as for finite paths. Acting near the end of the skein, they unwind the coils  $\pi_3$  one at a time, right-to-left. As a  $\mathfrak{g}$ -module,  $\widehat{V}(\Lambda_0)$  is an infinite tensor power of  $V(\varpi_1^*)$ .

## References

- [Bour] N. Bourbaki, *Groupes et Algèbres de Lie*, Chapitres 4, 5 et 6, Hermann, Paris (1968).
- [DJKMO] E. Date, M. Jimbo, A. Kuniba, T. Miwa and M. Okado, *A Path space realization of the basic representation of  $A_n^{(1)}$* , in *Infinite-Dimensional Lie Algebras and Groups*, Adv. Ser. in Math. Phys. **7**, World Sci. (1989), 108–123.
- [GM] D. Grabiner, P. Magyar, *Random walks in Weyl chambers and the decomposition of tensor powers*, *J. Algebraic Combin.* **2** (1993), 239–260.
- [HKKOT] G. Hatayama, Y. Koga, A. Kuniba, M. Okado, T. Takagi, *Finite Crystals and Paths*, in *Combinatorial methods in representation theory* (Kyoto, 1998), Adv. Stud. Pure Math. **28** (2000), 113–132. arXiv.org/math.QA/9901082
- [HK] J. Hong and S-J. Kang, *Introduction to Quantum Groups and Crystal Bases*, Grad. Stud. in Math. **42**, Amer. Math. Soc. (2002).
- [Ion] B. Ion, *Nonsymmetric Macdonald polynomials and Demazure characters*. *Duke Math. J.* **116** (2003), 299–318.
- [Jos] A. Joseph, *Quantum Groups and Their Primitive Ideals*, Springer Verlag, New York (1994).
- [Kac] V.G. Kac, *Infinite Dimensional Lie Algebras*, 3rd ed., Cambridge University Press (1990).
- [KKMMNN] S-J. Kang, M. Kashiwara, K.C. Misra, T. Miwa, T. Nakashima and A. Nakayashiki, *Perfect crystals of quantum affine Lie algebras*, *Duke Math. J.* **68** (1992), 499–607.
- [K1] M. Kashiwara, *On crystal bases of  $q$ -analog of universal enveloping algebras*, *Duke Math. J.* **63** (1991), 465–516.
- [K2] M. Kashiwara, *On level-zero representation of quantized affine algebras*, *Duke Math. J.* **112** (2002), 117–195.
- [KMOTU1] A. Kuniba, K. Misra, M. Okado, T. Takagi, J. Uchiyama, *Demazure modules and perfect crystals*, *Comm. Math. Phys.* **192** (1998), 555–567.
- [KMOTU2] A. Kuniba, K. Misra, M. Okado, T. Takagi, J. Uchiyama, *Paths, Demazure crystals, and symmetric functions*, *J. Math. Phys.* **41** (2000), 6477–6486.
- [LS] V. Lakshmibai and C.S. Seshadri, *Standard monomial theory*, *Proceedings of the Hyderabad Conference on Algebraic Groups*, ed. S. Ramanan, Manoj Prakashan Madras (1991), 279–323.

- [LLM1] V. Lakshmibai, P. Littelmann and P. Magyar, Standard monomial theory for Bott-Samelson varieties, *Compositio Math.* **130** (2002), 293–318.
- [LLM2] V. Lakshmibai, P. Littelmann, P. Magyar, Standard monomial theory and applications, in Representation Theories and Geometry, ed. A. Broer, Kluwer Academic Publishers (1998), 319–364.
- [Lit1] P. Littelmann, A Littlewood-Richardson formula for symmetrizable Kac-Moody algebras, *Invent. Math.* **116** (1994), 329–346.
- [Lit2] P. Littelmann, Paths and root operators in representation theory, *Ann. Math.* **142** (1995), 499–525.
- [Lus] G. Lusztig, Introduction to Quantum groups, Progress in Mathematics **110**, Birkhäuser Verlag (1993).
- [Macd] I.G. Macdonald, *Affine Hecke algebras and orthogonal polynomials*, Cambridge Tracts in Mathematics **157**, Cambridge University Press (2003).
- [Mag] P. Magyar, *Littelmann paths for the basic representation of an affine Lie algebra*, <http://arxiv.org/math.RT/0308156>.
- [Oka] M. Okado, A. Schilling, M. Shimozono, Crystal bases and  $q$ -identities, in  $q$ -series with applications to combinatorics, number theory, and physics, Contemp. Math. **291**, Amer. Math. Soc. (2001), 29–53.
- [PR] G. Pappas and M. Rapoport, Local models in the ramified case I: the EL-case, *J. Alg. Geom.* **12** (2003), 107–145.
- [PS] A. Pressley and G. Segal, Loop Groups, Oxford Univ. Press (1986).
- [San] Y.B. Sanderson, On the connection between Macdonald polynomials and Demazure characters, *J. Alg. Combin.* **11** (2000), 269–275.
- [Ste] J. Stembridge, Minuscule elements of Weyl groups, *J. Algebra* **235** (2001), 722–743

DEPARTMENT OF MATHEMATICS, MICHIGAN STATE UNIVERSITY, EAST LANSING, MI, 48824  
E-mail address: [magyar@math.msu.edu](mailto:magyar@math.msu.edu)



## Tutte Meets Poincaré

Jeremy L. Martin

**Abstract.** Let  $G$  be a graph and  $\mathcal{X}^d(G)$  the space of all “pictures” of  $G$  in complex projective  $d$ -space. We prove that  $\mathcal{X}^d(G)$  has no torsion or odd-dimensional integral homology, and that its Poincaré series is a specialization of the Tutte polynomial of  $G$ . As an application to combinatorial rigidity theory, we give a criterion for  $d$ -parallel independence in terms of the Tutte polynomial. In the case that  $\mathcal{X}^d(G)$  is smooth (which is equivalent to the condition that  $G$  is an orchard), we give a presentation of its cohomology ring, and relate the intersection theory on  $\mathcal{X}^d(G)$  to the Schubert calculus on flag varieties.

**Résumé.** Soient  $G$  un graphe et  $\mathcal{X}^d(G)$  l’espace de toutes les “figures” de  $G$  dans l’espace complexe projectif  $d$ -dimensionnel. Nous prouvons que  $\mathcal{X}^d(G)$  ne présente ni de torsion, ni d’homologie entière en dimension impaire, et que sa série de Poincaré est une spécialisation du polynôme de Tutte de  $G$ . Comme application à la théorie combinatoire de la rigidité, nous développons un critère pour l’indépendance  $d$ -parallel en termes du polynôme de Tutte. Dans le cas où  $\mathcal{X}^d(G)$  est lisse (ce qui est équivalent à la condition que  $G$  soit un verger), nous donnons une présentation de son anneau de cohomologie, et relient la théorie d’intersection de  $\mathcal{X}^d(G)$  au calcul de Schubert sur les variétés de drapeaux.

### 1. Introduction

Let  $G$  be a graph with vertices  $V$  and edges  $E$ , and let  $d \geq 2$  be an integer. A *picture* of  $G$  in complex projective  $d$ -space  $\mathbb{P}^d = \mathbb{P}_{\mathbb{C}}^d$  consists of a point in  $\mathbb{P}^d$  for each vertex of  $G$  and a line for each edge, subject to containment conditions inherited from incidence in  $G$ . The set of all pictures of  $G$  is a projective algebraic set, the *picture space*  $\mathcal{X}^d(G)$ . In Section 2, we state our main result (Theorem 2.3) which expresses the Poincaré series of  $\mathcal{X}^d(G)$  as a specialization of the Tutte polynomial of  $G$ .

In Section 3, we apply this result to the theory of combinatorial rigidity. Briefly, a graph  $G$  is  *$d$ -parallel independent* if there are no constraints on the direction vectors of the lines in a generic picture of  $G$  in  $d$ -space. In fact, this is a *matroid* independence condition; see [11]. Generalizing a result of [8], we show that  $G$  is  $d$ -parallel independent if and only if  $\mathcal{X}^d(G)$  is irreducible and  $\dim \mathcal{X}^d(G) = d|V|$ , where  $\mathbf{v}(G)$  is the number of vertices of  $G$ . Whether these conditions hold can be determined from the Poincaré series of  $\mathcal{X}^d(G)$ , which implies that  $d$ -parallel independence is a function of the Tutte polynomial.

In section 4, we study the cohomology ring  $H^*(\mathcal{X}^d(G); \mathbb{Z})$  in the case that  $\mathcal{X}^d(G)$  is smooth. It turns out that smoothness is equivalent to the property that  $G$  is an “orchard”; that is, every edge is either a loop

---

2000 *Mathematics Subject Classification.* Primary 05C10; Secondary 05B35, 14N20, 52C35.

*Key words and phrases.* Picture space, Poincaré series, Tutte polynomial, parallel matroid, Schubert calculus.

Supported by an NSF Postdoctoral Fellowship.

or an isthmus (an edge whose deletion increases the number of connected components). In this case,  $\mathcal{X}^d(G)$  is an iterated projectivized vector bundle, so its cohomology ring may be presented in terms of Chern classes of line bundles, just as for Grassmannians and flag varieties (see, e.g., [2] or [4]). Using this presentation (Theorem 4.3), we apply the classical Schubert calculus of partial flag varieties to solve enumerative geometry problems in the picture space of an orchard.

The author wishes to thank his colleagues Wojciech Chachólski, Sandra Di Rocco, and Victor Reiner for numerous helpful discussions, and two anonymous reviewers at FPSAC 2004 for their thoughtful comments. This abstract is an abridged version of a longer paper [9] which is presently under review.

## 2. The Main Theorem

We assume familiarity with elementary graph theory (see, e.g., [10]) but will briefly mention a few key terms and notations. A *graph* is a pair  $G = (V, E)$ , where  $V = V(G)$  is a finite nonempty set of vertices and  $E = E(G)$  is a finite set of edges. An edge whose endpoints are equal is called a *loop*. A graph is *simple* if it has no loops or multiple edges; that is, an edge may be specified by its pair of endpoints. The numbers of vertices, edges and connected components of  $G$  will be denoted  $\mathbf{v}(G)$ ,  $\mathbf{e}(G)$ ,  $\mathbf{c}(G)$  respectively.

For  $e \in E$ , the *deletion*  $G - e$  is the graph  $(V, E \setminus \{e\})$ . In general, either  $\mathbf{c}(G - e) = \mathbf{c}(G)$  or  $\mathbf{c}(G - e) = \mathbf{c}(G) + 1$ ; in the latter case,  $e$  is called an *isthmus* (or *bridge* or *coloop*). If  $e$  is not a loop, the *contraction*  $G/e$  is obtained by removing  $e$  from  $G$  and identifying its endpoints with each other. An *isthmus* (or *bridge*) is an edge  $e$  such that  $\mathbf{c}(G - e) = \mathbf{c}(G) + 1$ ; otherwise,  $\mathbf{c}(G - e) = \mathbf{c}(G)$ .

**Definition 2.1.** Let  $G = (V, E)$  be a graph. The *Tutte polynomial*  $\mathbf{T}_G(x, y)$  is defined as follows. If  $\mathbf{e}(G) = 0$ , then  $\mathbf{T}_G(x, y) = 1$ . Otherwise,  $\mathbf{T}_G(x, y)$  is defined recursively as

$$(2.1) \quad \mathbf{T}_G(x, y) = \begin{cases} x \cdot \mathbf{T}_{G/e}(x, y) & \text{if } e \text{ is an isthmus,} \\ y \cdot \mathbf{T}_{G-e}(x, y) & \text{if } e \text{ is a loop,} \\ \mathbf{T}_{G-e}(x, y) + \mathbf{T}_{G/e}(x, y) & \text{otherwise.} \end{cases}$$

for any  $e \in E(G)$ . (It is a standard fact, albeit not immediate from the definition, that the choice of  $e$  does not matter.)

Many isomorphism invariants of graphs, such as the number of acyclic orientations and the chromatic polynomial, satisfy deletion-contraction recurrences akin to (2.1). The Tutte polynomial may thus be regarded as the most general deletion-contraction invariant. For a comprehensive treatment of many aspects of the Tutte polynomial, see [3].

There is an equivalent (and non-recursive) definition of the Tutte polynomial as a certain generating function for the edge subsets  $F \subset E(G)$ . Define the *rank* of  $F$ , denoted  $r(F)$ , as the cardinality of a maximal acyclic subset of  $F$ . Equivalently,  $r(F) = \mathbf{v}(G|_F) - \mathbf{c}(G|_F)$ , where  $G|_F$  is the subgraph with edges  $F$  and vertices

$$\{v \in V(G) : v \text{ is an endpoint of at least one edge of } F\}.$$

Then the Tutte polynomial may be defined in closed form as the *corank-nullity generating function*

$$(2.2) \quad \mathbf{T}_G(x, y) = \sum_{F \subset E(G)} (x - 1)^{r(E) - r(F)} (y - 1)^{|F| - r(F)}$$

[3, eq. 6.13]; this formula will be useful in the study the  $d$ -parallel matroid in Section 3.

The main objects of our study are projective algebraic sets which parametrize “pictures” of graphs. (For more details, see [8].)

**Definition 2.2.** Let  $G = (V, E)$  be a graph and  $d \geq 2$  a positive integer. Denote complex projective  $d$ -space by  $\mathbb{P}^d$ . A *picture*  $\mathbf{P}$  of  $G$  consists of a point  $\mathbf{P}(v) \in \mathbb{P}^d$  for each  $v \in V$  and a line  $\mathbf{P}(e)$  in  $\mathbb{P}^d$  for each  $e \in E$ ,



such that  $\mathbf{P}(v) \in \mathbf{P}(e)$  whenever  $v$  is an endpoint of  $e$ . The set of all pictures is called the  $d$ -dimensional picture space of  $G$ , denoted  $\mathcal{X}^d(G)$ .

Our main theorem concerns the enumeration of the (non-reduced) integral homology groups  $H_i(\mathcal{X}^d(G)) = H_i(\mathcal{X}^d(G); \mathbb{Z})$ .

**Theorem 2.3.** *Let  $G$  be a graph and  $d \geq 2$  an integer. Then*

- (1) *The picture space  $\mathcal{X}^d(G)$  is path-connected and simply connected.*
- (2)  *$H_i(\mathcal{X}^d(G))$  is free abelian for  $i$  even and zero for  $i$  odd.*
- (3) *The “compressed Poincaré series” defined by*

$$(2.3) \quad P_G^d(q) := \sum_i q^i \operatorname{rank}_{\mathbb{Z}} H_{2i}(\mathcal{X}^d(G))$$

(that is, the generating function for the even Betti numbers) is given by the formula

$$P_G^d(q) = ([d]_q - 1)^{\mathbf{v}(G) - \mathbf{c}(G)} [d + 1]_q^{\mathbf{c}(G)} \mathbf{T}_G \left( \frac{[2]_q [d]_q}{[d]_q - 1}, [d]_q \right)$$

where  $[d]_q = (1 - q^d)/(1 - q)$ .

In the remainder of this section, we sketch the proof of Theorem 2.3. We begin with a few elementary observations about picture spaces.

First,  $\mathcal{X}^d(G)$  is easily seen to be path-connected: any picture can be deformed continuously to a “maximally degenerate” picture in which all points (resp. lines) coincide, and the set of maximally degenerate pictures is isomorphic to a partial flag variety.

Second,  $\mathcal{X}^d(G)$  is the product of the picture spaces of the connected components of  $G$ . In particular, if  $\mathbf{e}(G) = 0$ , then  $\mathcal{X}^d(G) \cong (\mathbb{P}^d)^{\mathbf{v}(G)}$ . Moreover, if  $e$  is a loop, then  $\mathcal{X}^d(G)$  is a  $\mathbb{P}^{d-1}$ -bundle over  $\mathcal{X}^d(G - e)$ .

At the heart of our methods are two canonical morphisms between picture spaces that correspond to the graph operations of deletion and contraction. First, for every  $e \in E(G)$ , there is a natural epimorphism

$$(2.4) \quad \mathcal{X}^d(G) \twoheadrightarrow \mathcal{X}^d(G - e)$$

given by forgetting the data for the line  $\mathbf{P}(e)$ . (In fact, there is a canonical epimorphism  $\mathcal{X}^d(G) \xrightarrow{\tilde{\Omega}} \mathcal{X}^d(G')$  for any subgraph  $G'$  of  $G$ , but this is the most important case for our present purposes.)

Let  $e$  be a nonloop edge with endpoints  $v, w$ . The *coincidence locus* of  $e$  in  $\mathcal{X}^d(G)$  is defined as

$$(2.5) \quad Z_e(G) = Z_{vw}(G) := \{ \mathbf{P} \in \mathcal{X}^d(G) \mid \mathbf{P}(v) = \mathbf{P}(w) \}.$$

The second canonical map is the natural monomorphism

$$(2.6) \quad \mathcal{X}^d(G/e) \hookrightarrow \mathcal{X}^d(G - e)$$

whose image is the coincidence locus  $Z_e(G - e)$ .

We remark briefly that in light of (2.4) and (2.6), one may regard  $\mathcal{X}^d$  as a contravariant functor from the category of graphs to that of projective algebraic sets.

The maps (2.4) and (2.6) form part of a commutative diagram

$$(2.7) \quad \begin{array}{ccc} Z_e(G) & \hookrightarrow & \mathcal{X}^d(G) \\ \downarrow & & \downarrow \\ \mathcal{X}^d(G/e) & \hookrightarrow & \mathcal{X}^d(G - e) \end{array}$$

By a technical but not difficult argument, one can show that the map  $Z_e(G) \xrightarrow{\tilde{\Omega}} \mathcal{X}^d(G/e)$  is a  $\mathbb{P}^{d-1}$ -fibration, and that the diagram (2.7) is a homotopy pushout square. Consequently, there is a Mayer-Vietoris long exact

sequence

$$(2.8) \quad \dots \tilde{\Omega} H_i(Z_e(G)) \tilde{\Omega} H_i(\mathcal{X}^d(G/e)) \oplus H_i(\mathcal{X}^d(G)) \tilde{\Omega} H_i(\mathcal{X}^d(G-e)) \\ \tilde{\Omega} H_{i-1}(Z_e(G)) \tilde{\Omega} \dots$$

We first consider two simple cases. If  $\mathbf{e}(G) = 0$ , then  $\mathcal{X}^d(G) \cong (\mathbb{P}^d)^{\mathbf{v}(G)}$ , while if  $\mathbf{v}(G) = 1$ , then  $\mathcal{X}^d(G)$  is a  $(\mathbb{P}^{d-1})^{\mathbf{e}(G)}$ -bundle over  $\mathbb{P}^d$ , whose Poincaré series is the same as that of  $\mathbb{P}^d \times (\mathbb{P}^{d-1})^{\mathbf{e}(G)}$  (see, e.g., Proposition 2.3 of [5]). In both cases,  $\mathcal{X}^d(G)$  is a simply connected complex manifold with no torsion or odd-dimensional integral homology. Since the compressed Poincaré series of  $\mathbb{P}^d_{\mathbb{C}}$  is  $[d+1]_q$ , we have

$$(2.9) \quad P_G^d(q) = \begin{cases} [d+1]_q^{\mathbf{v}(G)} & \text{if } \mathbf{e}(G) = 0, \\ [d]_q^{\mathbf{e}(G)} [d+1]_q & \text{if } \mathbf{v}(G) = 1. \end{cases}$$

We now consider the general case. To show that  $\mathcal{X}^d(G)$  is simply connected and has no torsion or odd-dimensional homology, we proceed inductively, choosing an edge  $e$  and assuming these properties for  $\mathcal{X}^d(G-e)$  and  $\mathcal{X}^d(G/e)$ . Since  $Z_e(G)$  is a  $\mathbb{P}^{d-1}$ -bundle over  $\mathcal{X}^d(G/e)$ , it follows from Proposition 2.3 of [5] that  $Z_e(G)$  has no torsion or odd-dimensional homology (essentially because the Leray-Serre spectral sequence degenerates quickly), so that (2.8) splits into short exact sequences

$$(2.10) \quad 0 \tilde{\Omega} H_i(Z) \tilde{\Omega} H_i(\mathcal{X}^d(G/e)) \oplus H_i(\mathcal{X}^d(G)) \tilde{\Omega} H_i(\mathcal{X}^d(G-e)) \tilde{\Omega} 0,$$

from which we obtain the desired properties for  $\mathcal{X}^d(G)$ . Furthermore, the short exact sequences (2.10) lead to recurrences expressing the compressed Poincaré series  $P_G^d(q)$  in terms of  $P_{G-e}^d(q)$  and  $P_{G/e}^d(q)$ . By suitable normalizations, these recurrences can be transformed into the Tutte recurrence (2.2).

### 3. Parallel Independence

Let  $\mathbf{P}$  be a  $d$ -dimensional picture of a simple graph  $G = (V, E)$  (that is, with no loops or multiple edges). Consider a physical model of  $\mathbf{P}$  consisting of a “bar” for each edge  $e$  and a “joint” for each vertex  $v$ . If  $e$  has  $v$  as an endpoint, then the corresponding bar is attached to the corresponding joint. The bars may cross, and their lengths are allowed to vary, but we fix the angles at which the bars are attached to the joints. Thus, for example, a square framework may be deformed to produce an arbitrary rectangle, but not any other rhombus. Under what conditions on  $G$  is such a model rigid? That is, when is the model determined up to congruence by specifying the attaching angles? These and similar questions are the focus of *combinatorial rigidity theory*; for more details, see, e.g., [6] and [11].

The graph  $G$  (or, more properly, its edge set) is said to be  *$d$ -parallel independent* if for a generic picture in  $\mathcal{X}^d(G)$ , the directions of the lines representing edges are mutually unconstrained. This is in fact a *matroid* independence condition on edge sets; for the reader not familiar with matroids, we remark here only that it satisfies certain axioms which abstract the idea of linear independence in a vector space. In particular, loops and multiple edges are dependent sets in  $t$

The Poincaré series formula of Theorem 2.3 can be applied to give the following criterion for independence in the  $d$ -parallel matroid:

**Theorem 3.1.** *Let  $d$  be a positive integer and  $G$  a simple graph (with no loops or multiple edges). Then  $E(G)$  is independent in the generic  $d$ -parallel matroid if and only if the polynomial*

$$([d]_q - 1)^{\mathbf{v}(G) - \mathbf{c}(G)} \mathbf{T}_G \left( \frac{[2]_q [d]_q}{[d]_q - 1}, [d]_q \right)$$

*is monic of degree  $d(\mathbf{v}(G) - \mathbf{c}(G))$ .*

We briefly sketch the proof of Theorem 3.1. The first fact we need is that the leading term of  $\text{Poin}(X; q)$  is  $cq^{2d}$ , where  $d = \dim_{\mathbb{C}} X$  and  $c$  is the number of irreducible components of  $X$  of dimension  $d$ ; see [4, Appendix A, Lemmas 2 and 4].

Call a picture  $\mathbf{P}$  of  $G$  *generic* if the points  $\mathbf{P}(v)$ , for  $v \in V(G)$ , are all distinct. The *picture variety*  $\mathcal{V}^d(G)$  is the closure of the set of generic pictures; in general,  $\mathcal{V}^d(G)$  is an irreducible component of  $\mathcal{X}^d(G)$  of dimension  $2\mathbf{v}(G)$ , and all other components have equal or greater dimension (for details, see [8]). Furthermore, Theorem 4.5 of [8] admits the following generalization: For  $G$  a simple graph and  $d \geq 2$ ,  $E(G)$  is  $d$ -parallel independent if and only if  $\mathcal{X}^d(G) = \mathcal{V}^d(G)$ .

Combining these observations with Theorem 2.3, one sees that  $d$ -parallel independence is equivalent to the condition that the compressed Poincaré series

$$([d]_q - 1)^{\mathbf{v}(G) - \mathbf{c}(G)} [d + 1]_q^{\mathbf{c}(G)} \mathbf{T}_G \left( \frac{[2]_q [d]_q}{[d]_q - 1}, [d]_q \right)$$

be monic of degree  $d \cdot \mathbf{v}(G)$ . On the other hand, the corank-nullity generating function (2.2) says that

$$\mathbf{T}_G \left( \frac{[2]_q [d]_q}{[d]_q - 1}, [d]_q \right) = \frac{f(q)}{([d]_q - 1)^{r(E)}} = \frac{f(q)}{([d]_q - 1)^{\mathbf{v}(G) - \mathbf{c}(G)}}$$

where  $f(q)$  is a polynomial in  $q$ , and  $r$  is the rank function on subsets of  $E$  (see Section 2). Therefore, we may divide the compressed Poincaré series by  $[d + 1]_q^{\mathbf{c}(G)}$  yields a polynomial in  $q$  to obtain the statement of Theorem 3.1.

#### 4. Orchard Schubert Calculus

**4.1. The cohomology ring of an orchard.** An edge  $e$  in a graph  $G$  is an *isthmus* if  $\mathbf{c}(G - e) = \mathbf{c}(G) + 1$  (otherwise  $\mathbf{c}(G - e) = \mathbf{c}(G)$ ). We denote the number of isthmuses and loops by  $\mathbf{i}(G)$  and  $\ell(G)$  respectively. In addition, if  $v$  is an endpoint of  $e$ , we will write  $e \in E(v)$  or say that  $v, e$  is an *incident pair*.

An *orchard* is a graph  $G$  such that every edge is either an isthmus or a loop; that is,  $\mathbf{e}(G) = \mathbf{i}(G) + \ell(G)$ . In this case, the Tutte polynomial of  $G$  is

$$\mathbf{T}_G(x, y) = x^{\mathbf{i}(G)} y^{\ell(G)},$$

so by Theorem 2.3 the compressed Poincaré series of  $\mathcal{X}^d(G)$  is

$$(4.1) \quad P_G^d(q) = [d + 1]_q^{\mathbf{c}(G)} [2]_q^{\mathbf{i}(G)} [d]_q^{\ell(G)}.$$

This polynomial is palindromic, suggesting that the picture space of an orchard is smooth (by Poincaré duality). In fact, more is true.

**Proposition 4.1.** *Let  $G = (V, E)$  be a graph and  $d \geq 2$ . The picture space  $\mathcal{X}^d(G)$  is smooth if and only if  $G$  is an orchard.*

Proposition 4.1 is proved as follows. When  $G$  is an orchard,  $\mathcal{X}^d(G)$  may be realized explicitly as an iterated projective bundle over  $\mathbb{P}^d$  with smooth fibers. If  $G$  is not an orchard, let  $\mathbf{P}$  be a generic picture (where no points coincide) and let  $\mathbf{Q}$  be a picture that is “maximally degenerate”—that is, all points  $\mathbf{Q}(v)$  coincide, as do all lines  $\mathbf{Q}(e)$ . Then one can show directly that the tangent space to  $\mathcal{X}^d(G)$  at  $\mathbf{P}$  has dimension exactly  $d \cdot \mathbf{v}(G)$ , while the tangent space at  $\mathbf{Q}$  has strictly greater dimension; it follows that  $\mathbf{Q}$  is a singular point.

**Remark 4.2.** If  $G$  is an orchard then  $P_G^d(q)$  is palindromic, by Proposition 4.1 and Poincaré duality. The converse is not true. For instance, let  $G$  have two vertices and three nonloop edges. Then  $\mathcal{X}^2(G)$  is not smooth, but by Theorem 2.3 its compressed Poincaré series is  $1 + 5q + 9q^2 + 9q^3 + 5q^4 + q^5$ .

We will need several facts about vector bundles over complex manifolds. For more details, see chapter IV of [2], especially pp. 269–271. The main fact is as follows. Let  $M$  be a complex manifold and  $\mathcal{E}$  a complex vector bundle on  $M$  of rank  $d$ . The *projectivization* of  $\mathcal{E}$  is the fiber bundle  $\mathbb{P}(\mathcal{E}) \xrightarrow{\pi} M$  whose fiber at a point  $m \in M$  is  $\mathbb{P}(\mathcal{E})_m = \mathbb{P}(\mathcal{E}_m)$ , that is, the space of lines through the origin in the fiber of  $\mathcal{E}$  at  $m$ . Thus  $\pi^{-1}\mathcal{E}$  is

a rank- $d$  vector bundle over  $\mathbb{P}(\mathcal{E})$ . The *tautological subbundle*  $\mathcal{L}$  is the line bundle on  $\mathbb{P}(\mathcal{E})$  defined fiberwise by  $\mathcal{L}_p = p$  (regarding  $p$  as a line in  $\mathcal{E}_{\pi(p)}$ ). With this setup,

$$(4.2) \quad H^*(\mathbb{P}(\mathcal{E})) \cong H^*(M)[x] / (x^d + c_1(\mathcal{E})x^{d-1} + \cdots + c_d(\mathcal{E}))$$

where  $c_i(\mathcal{E})$  denotes the  $i$ th Chern class of  $\mathcal{E}$ , and  $x = c_1(\mathcal{L}^*)$ , the first Chern class of the dual line bundle  $\mathcal{L}^*$ .

The idea of the presentation of  $H^*(\mathcal{X}^d(G))$  (to follow in Theorem 4.3) is that we can say precisely how the graph-theoretic operations of deletion and contraction correspond to projectivizations of certain vector bundles. Every nontrivial orchard can be “pruned”; that is, we can identify a simpler orchard  $G'$  and a vector bundle  $\mathcal{E}$  on  $\mathcal{X}^d(G')$  such that  $\mathcal{X}^d(G) = \mathbb{P}(\mathcal{E})$ . Moreover, the fiber of  $\mathcal{E}$  has an elementary description in terms of the data for a picture  $\mathbf{P}$  of  $G'$ . By the aforementioned machinery of Chern classes, in particular (4.2), we can express  $H^*(\mathcal{X}^d(G))$  as an algebra over  $\mathcal{X}^d(G')$ .

Let  $e \in E(G)$ . We have already seen that if  $e$  is a loop and  $G' = G - e$ , then  $\mathcal{X}^d(G)$  is a  $\mathbb{P}^{d-1}$ -bundle over  $\mathcal{X}^d(G')$ . More precisely, if  $v$  is the unique endpoint of  $e$ , then  $\mathcal{X}^d(G) = \mathbb{P}(\mathcal{W}/\mathcal{L}_v)$ , where  $\mathcal{W}$  is the trivial bundle of rank  $d + 1$  and  $\mathcal{L}_v$  is the line bundle whose fiber is  $\mathbf{P}(v)$ .

Now suppose that  $e$  is an isthmus. It suffices to consider the case that  $e$  is the “stem of a leaf  $v$ ”; that is,  $v \in V(G)$  and  $E(v) = \{e\}$ . Let  $w$  be the other endpoint of  $e$ , and let  $G'$  be the graph obtained from  $G$  by deleting  $e$  and  $v$  and attaching a loop  $e'$  at the other endpoint of  $e$ . Then  $\mathcal{X}^d(G) = \mathbb{P}(\mathcal{F}_e)$ , where  $\mathcal{F}_e$  is the plane bundle on  $\mathcal{X}^d(G')$  with fiber  $\mathbf{P}(e)$ .

**Theorem 4.3.** *Let  $G = (V, E)$  be an orchard, with vector bundles  $\mathcal{L}_v$  and  $\mathcal{F}_e$  as above. For each  $v \in V$ , let  $x_v = c_1(\mathcal{L}_v^*)$ , and for each incident pair  $v, e$ , let  $y_{v,e} = c_1((\mathcal{F}_e/\mathcal{L}_v)^*)$ . Then*

$$H^*(\mathcal{X}^d(G); \mathbb{Z}) \cong \mathbb{Z}[x_v, y_{v,e} : v \in V, e \in E(v)] / I_G,$$

where  $I_G$  is the ideal

$$I_G = \left\langle \begin{array}{ll} x_v^{d+1} & \text{for } v \in V, \\ h_d(x_v, y_{v,e}) & \text{for } v \in V, e \in E(v), \\ x_v - x_w + y_{v,e} - y_{w,e}, \quad x_v y_{v,e} - x_w y_{w,e} & \text{for } e = vw \end{array} \right\rangle.$$

Here  $h_d(x, y) = x^d + x^{d-1}y + \cdots + xy^{d-1} + y^d$  is the  $d$ th complete homogeneous symmetric function in  $x$  and  $y$ , and  $e = vw$  means that  $e$  is an isthmus with endpoints  $v, w$ .

Setting  $z_e := c_1(\mathcal{F}_e)$ , the Whitney product formula for vector bundles gives the relations  $z_e = x_v + y_{v,e} = x_w + y_{w,e}$  whenever  $e$  is an edge with endpoints  $v, w$ . This yields an equivalent and somewhat more concise presentation of the cohomology ring.

**Corollary 4.4.** *Let  $G$  be an orchard and  $x_v, z_e$  as above.*

*Then  $H^*(\mathcal{X}^d(G)) = \mathbb{Z}[x_v, z_e : v \in V, e \in E] / J_G$ , where*

$$J_G = \left\langle \begin{array}{ll} x_v^{d+1} & \text{for } v \in V, \\ h_d(x_v, z_e - x_v) & \text{for } v \in V, e \in E(v), \\ (x_v - x_w)(z_e - x_v - x_w) & \text{for } e = vw \end{array} \right\rangle.$$

**4.2. Enumerative geometry.** The Schubert calculus (see, e.g., [7] or [4]) reduces certain enumerative geometry questions to calculations in the cohomology ring of a flag manifold. If  $G$  is an orchard, then the presentation of  $H^*(\mathcal{X}^d(G))$  given in Theorem 4.3, together with the canonical epimorphism (2.4), allows us to answer similar enumerative geometry questions about pictures of  $G$ .

Let  $L_1$  be the graph consisting of a vertex and a loop. A picture of  $L_1$  is a point lying on a line in complex projective  $d$ -space, or equivalently a line through the origin lying on a plane in  $\mathbb{C}^{d+1}$ . That is,  $\mathcal{X}^d(L_1)$  is naturally isomorphic to the partial flag manifold  $F\ell^{1,2}(d+1)$  (in the notation of [4]).

More generally, suppose that  $G$  is an orchard,  $v \in V(G)$ , and  $e \in E(v)$ . As in (2.4), there is an epimorphism (in fact, a smooth fibration)

$$(4.3) \quad \pi_{v,e} : \mathcal{X}^d(G)\tilde{\Omega}\mathcal{X}^d(L_1) \cong F\ell^{1,2}(d+1)$$

forgetting all data except  $\mathbf{P}(v)$  and  $\mathbf{P}(e)$ . This gives a decomposition of  $\mathcal{X}^d(G)$  as a disjoint union of *orchard Schubert cells*

$$\Omega_\sigma^\circ = \bigcap_{e \in E(v)} \pi^{-1}(\Omega_{\sigma_{v,e}}^\circ)$$

indexed by  $(2\mathbf{i}(G) - \ell(G))$ -tuples  $\sigma$  of permutations  $\sigma_{v,e}$  in the symmetric group  $S_{d+1}$ .

By induction on  $\mathbf{e}(G)$ , one can show that each  $\Omega_\sigma^\circ$  is isomorphic to an affine space. Moreover, it is not hard to identify permutations  $\sigma_{v,e}$  for which  $\Omega_\sigma^\circ$  is nonempty. We expect that in general the *orchard Schubert variety*  $\Omega_\sigma = \overline{\Omega_\sigma^\circ}$  should be a union of orchard Schubert cells.

**Problem 4.5.** Describe the orchard Bruhat order, the partial order on tuples of partitions given by  $\sigma \preceq \tau$  iff  $\Omega_\sigma^\circ \subseteq \Omega_\tau$ .

In general, the orchard Bruhat order is weaker than the product of the various strong Bruhat orders: that is,  $\sigma \preceq \tau$  implies that  $\sigma_{v,e} \leq \tau_{v,e}$  in the strong Bruhat order for all incident pairs  $v, e$ . The converse is false in general. For example, if  $G = K_2$  is the complete graph on two vertices and  $d = 2$ , then  $(231, 231)$  and  $(213, 213)$  are incomparable in the orchard Bruhat order, even though  $231 > 213$  in the Bruhat order on  $S_3$ .

The fibrations (4.3) induce pullback monomorphisms of cohomology rings

$$\pi_{v,e}^* : H^*(F\ell^{1,2}(d+1))\tilde{\Omega}H^*(\mathcal{X}^d(G))$$

for every incident pair  $v, e$ . This observation allows us to extend the Schubert calculus of (partial) flag varieties to solve enumerative geometry problems about picture of orchards. We devote the remainder of this section to a typical problem and its solution. (For this and many similar computations, the author used the computer algebra system *Macaulay* [1].)

**Example 4.6.** Let  $G$  be the tree with vertices  $V = \{1, 2, 3\}$  and edges  $E = \{12, 13\}$ :

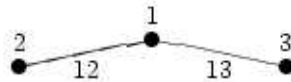

Let  $A_1, A_2, A_3 \subset \mathbb{P}^3$  be planes, and let  $A_4, \dots, A_9 \subset \mathbb{P}^3$  be lines, with the collection  $\{A_i\}$  in general position. We will calculate the number of pictures of  $G$  in  $\mathbb{P}^3$  satisfying the conditions

$$(4.4) \quad \begin{aligned} \mathbf{P}(i) &\in A_i && \text{for } i = 1, 2, 3, \\ \mathbf{P}(12) \cap A_i &\neq \emptyset && \text{for } i = 4, 5, 6, \\ \mathbf{P}(13) \cap A_i &\neq \emptyset && \text{for } i = 7, 8, 9. \end{aligned}$$

For  $i = 1, \dots, 9$ , let  $Y_i$  be the subvariety of  $\mathcal{X}^3(G)$  consisting of pictures  $\mathbf{P}$  for which the condition involving  $A_i$  is satisfied. Then the problem is to determine the cardinality of  $Y = \bigcap_i Y_i$ . Each  $Y_i$  is the pullback of some Schubert variety  $\Omega_\sigma \subseteq F\ell^{1,2}(\mathbb{C}^4)$ , so its cohomology class is a Schubert polynomial (see [4]) in the variables  $x_1, x_2, x_3, z_{12}, z_{13}$  (using the presentations of Theorem 4.3 and Corollary 4.4). For instance,

$$\begin{aligned} [Y_1] &= [\pi_{1,12}^{-1}(\Omega_{2134})] = \mathfrak{S}_{2134}(x_1, z_{12} - x_1) = x_1 && \text{and} \\ [Y_4] &= [\pi_{1,12}^{-1}(\Omega_{1324})] = \mathfrak{S}_{1324}(x_1, z_{12} - x_1) = z_{12}. \end{aligned}$$

By similar calculations, we find that

$$\begin{aligned} [Y_2] &= x_2, & [Y_5] &= [Y_6] = z_{12}, \\ [Y_3] &= x_3, & [Y_7] &= [Y_8] = [Y_9] = z_{13}. \end{aligned}$$

Therefore  $[Y] = x_1x_2x_3z_{12}^3z_{13}^3$ . Finally, the cohomology class of a point in  $\mathcal{X}^3(G)$  is  $(x_1x_2x_3)^3$ . Since

$$x_1x_2x_3z_{12}^3z_{13}^3 = 4(x_1x_2x_3)^3$$

in  $H^*(\mathcal{X}^3(G))$ , we conclude that  $|Y| = 4$ . That is, there exist four pictures of the orchard  $G$  satisfying the conditions (4.4).

This cohomological calculation depends on the fact that the subvarieties  $Y_i$  meet transversely. For the stated example, this can be verified by solving the enumerative problem directly geometrically; however, the author (who is not an expert on Schubert calculus) does not at present have a more general transversality result.

### References

- [1] David Bayer and Michael Stillman, *Macaulay: a computer algebra system for algebraic geometry*, software, 1994. Available at <http://www.math.columbia.edu/~bayer/Macaulay/>.
- [2] Raoul Bott and Loring W. Tu, *Differential forms in algebraic topology*, Graduate Texts in Mathematics, vol. 82, Springer-Verlag, New York, 1982.
- [3] Thomas Brylawski and James Oxley, *The Tutte polynomial and its applications*, Encyclopedia Math. Appl., vol. 40, pp. 123–225, Cambridge University Press, Cambridge, 1992.
- [4] William Fulton, *Young tableaux*, Cambridge University Press, New York, 1997.
- [5] Veselin Gasharov and Victor Reiner, *Cohomology of smooth Schubert varieties in partial flag manifolds*, J. London Math. Soc. **66** (2002), 550–562.
- [6] Jack Graver, Brigitte Servatius and Herman Servatius, *Combinatorial rigidity*, Graduate Studies in Mathematics, vol. 2, Amer. Math. Soc., 1993.
- [7] S. L. Kleiman and Dan Laksov, *Schubert calculus*, Amer. Math. Monthly **79** (1972), 1061–1082.
- [8] Jeremy L. Martin, *Geometry of graph varieties*, Trans. Amer. Math. Soc. **355** (2003), 4151–4169.
- [9] Jeremy L. Martin, *On the topology of multigraph picture spaces*, preprint, [arXiv:math.CO/0307405](https://arxiv.org/abs/math/0307405).
- [10] Douglas B. West, *Introduction to graph theory*, Prentice Hall, Upper Saddle River, NJ, 2nd edition, 2001.
- [11] Walter Whiteley, *Some matroids from discrete applied geometry*, Matroid theory (Seattle, WA, 1995), Contemp. Math., vol. 197, Amer. Math. Soc., Providence, RI, 1996, pp. 171–311.

SCHOOL OF MATHEMATICS, UNIVERSITY OF MINNESOTA, MINNEAPOLIS, MN 55455  
*E-mail address:* [martin@math.umn.edu](mailto:martin@math.umn.edu)



## A Hopf Algebra of Parking Functions

J.-C. Novelli and J.-Y. Thibon

**Abstract.** *If the moments of a probability measure on  $\mathbb{R}$  are interpreted as a specialization of complete homogeneous symmetric functions, its free cumulants are, up to sign, the corresponding specializations of a sequence of Schur positive symmetric functions  $(f_n)$ . We prove that  $(f_n)$  is the Frobenius characteristic of the natural permutation representation of  $\mathfrak{S}_n$  on the set of prime parking functions. This observation leads us to the construction of a Hopf algebra of parking functions, which we study in some detail.*

**Résumé.** *Si on interprète les moments d'une mesure de probabilité sur  $\mathbb{R}$  comme une spécialisation de fonctions symétriques complètes, ses cumulants libres sont, au signe près, les spécialisations correspondantes d'une suite de fonctions symétriques  $(f_n)$  Schur-positives. Nous montrons que  $(f_n)$  est la caractéristique de Frobenius d'une représentation permutationnelle naturelle de  $\mathfrak{S}_n$  sur l'ensemble des fonctions de parking primitives. Cette observation nous conduit à construire une algèbre de Hopf des fonctions de parking que nous étudions ensuite en détail.*

### 1. Introduction

The free cumulants  $R_n$  of a probability measure  $\mu$  on  $\mathbb{R}$  are defined (see e.g., [20]) by means of the generating series of its moments  $M_n$

$$(1.1) \quad G_\mu(z) := \int_{\mathbb{R}} \frac{\mu(dx)}{z-x} = z^{-1} + \sum_{n \geq 1} M_n z^{-n-1}$$

as the coefficients of its compositional inverse

$$(1.2) \quad K_\mu(z) := G_\mu(z)^{\langle -1 \rangle} = z^{-1} + \sum_{n \geq 1} R_n z^{n-1}.$$

It is in general instructive to interpret the coefficients of a formal power series as the specializations of the elements of some generating family of the algebra of symmetric functions. In this context, it is the interpretation

$$(1.3) \quad M_n = \phi(h_n) = h_n(A)$$

---

1991 *Mathematics Subject Classification.* 05E05, 20C30, 16S40, 05C05.

*Key words and phrases.* Hopf algebras, Parking functions, Quasi-symmetric functions, Trees.

Both authors were partially supported by EC's IHRP Programme, grant HPRN-CT-2001-00272, "Algebraic Combinatorics in Europe".

which is relevant. Indeed, the process of functional inversion (Lagrange inversion) admits a simple expression within this formalism (see [14], ex. 24 p. 35). If the symmetric functions  $h_n^*$  are defined by the equations

$$(1.4) \quad u = tH(t) \iff t = uH^*(u)$$

where  $H(t) := \sum_{n \geq 0} h_n t^n$ ,  $H^*(u) := \sum_{n \geq 0} h_n^* u^n$ , then, using the  $\lambda$ -ring notation,

$$(1.5) \quad h_n^*(X) = \frac{1}{n+1} (-1)^n e_n((n+1)X) := \frac{1}{n+1} [t^n] E(-t)^{n+1}$$

where  $E(t)$  is defined by  $E(t)H(t) = 1$ . This defines an involution  $f \mapsto f^*$  of the ring of symmetric functions.

Now, if one sets  $M_n = h_n(A)$  as above, then

$$(1.6) \quad G_\mu(z) = z^{-1} H(z^{-1}) = u \iff z = K_\mu(u) = \frac{1}{u} E^*(-u) = u^{-1} + \sum_{n \geq 1} (-1)^n e_n^* u^{n-1}.$$

Hence,

$$(1.7) \quad R_n = (-1)^n e_n^*(A).$$

It follows immediately from the explicit formula (see [14] p. 35)

$$(1.8) \quad -e_n^* = \frac{1}{n-1} \sum_{\lambda \vdash n} \binom{n-1}{l(\lambda)} \binom{l(\lambda)}{m_1, m_2, \dots, m_n} e_\lambda$$

(where  $\lambda = 1^{m_1} 2^{m_2} \dots n^{m_n}$ ) that  $-e_n^*$  is Schur positive. Clearly,  $-e_n^*$  is the Frobenius characteristic of a permutation representation  $\Pi_n$ , twisted by the sign character. Let us set

$$(1.9) \quad (-1)^{(n-1)} R_n = -e_n^* =: \omega(f_n)$$

so that  $f_n$  is the character of  $\Pi_n$ . We start with a construction of this representation in terms of parking functions. This leads us to the definition of a Hopf algebra of parking functions that generalizes the constructions of [15, 3]. We expect that this combinatorics can be generalized to other root systems, at least for type B (see, e.g., [2]).

We note that our construction of  $\Pi_n$  is merely a variation about previously known results (see in particular [12, 17]). However, since this is this precise version that led us to the Hopf algebra of parking functions and some of its properties, we decided to present it in detail.

Although many definitions will be recalled, we shall assume that the reader is familiar with the notation of [5, 3].

*Acknowledgements.*— The problem of constructing the representation  $\Pi_n$  was suggested by S. Kerov during his stay in Marne-la-Vallée in 1996. The question was forgotten for a long time without any attempt of solution, and rediscovered recently on the occasion of talks by S. Ferrière and P. Biane. Thanks also to P. Biane for providing the reference [17].

## 2. Parking functions

**2.1. Parking functions.** A *parking function* on  $[n] = \{1, 2, \dots, n\}$  is a word  $\mathbf{a} = a_1 a_2 \dots a_n$  of length  $n$  on  $[n]$  whose nondecreasing rearrangement  $\mathbf{a}^\uparrow = a'_1 a'_2 \dots a'_n$  satisfies  $a'_i \leq i$  for all  $i$ . Let  $\text{PF}_n$  be the set of such words. It is well-known that  $|\text{PF}_n| = (n+1)^{n-1}$ , and that the permutation representation of  $\mathfrak{S}_n$  naturally supported by  $\text{PF}_n$  has Frobenius characteristic  $(-1)^n \omega(h_n^*)$  (see [8]).

**2.2. Prime parking functions.** Gessel introduced in 1997 (see [22]) the notion of *prime parking function*. One says that  $\mathbf{a}$  has a *breakpoint* at  $b$  if  $|\{\mathbf{a}_i \leq b\}| = b$ . Then,  $\mathbf{a} \in \text{PF}_n$  is said to be prime if its only breakpoint is  $b = n$ .

Let  $\text{PPF}_n \subset \text{PF}_n$  be the set of prime parking functions on  $[n]$ . It can easily be shown that  $|\text{PPF}_n| = (n-1)^{n-1}$  (see [22, 10]).



**2.3. Operations on parking functions.** For a word  $w$  on the alphabet  $1, 2, \dots$ , denote by  $w[k]$  the word obtained by replacing each letter  $i$  by  $i + k$ . If  $u$  and  $v$  are two words, with  $u$  of length  $k$ , one defines the *shifted concatenation*

$$(2.1) \quad u \bullet v = u \cdot (v[k])$$

and the *shifted shuffle*

$$(2.2) \quad u \uplus v = u \sqcup \sqcup (v[k]).$$

It is immediate to see that the set of permutations is closed under both operations, and that the subalgebra spanned by those elements is isomorphic to the convolution algebra of symmetric groups (see [15]) or to Free Quasi-Symmetric Functions (see [3]).

It is equally immediate to see that the set of all parking functions is closed under these operations and that the prime parking functions exactly are the parking functions that do not occur in any nontrivial shifted shuffle of parking functions. These properties allow us to define a Hopf algebra of parking functions (see Section 3).

Let us now move to representation theory.

**2.4. The module of prime parking functions.** Recall that the expression of complete symmetric functions in the basis  $e_\lambda$  is the commutative image of the formula

$$(2.3) \quad (-1)^n S_n = \sum_{I \models n} (-1)^{l(I)} \Lambda^I$$

which, applied to  $h_n^*$ , gives

$$(2.4) \quad \text{ch}(\text{PF}_n) = (-1)^n \omega(h_n^*) = \sum_{I \models n} f_{i_1} \cdot f_{i_2} \cdots f_{i_r}.$$

Now, let us interpret this last formula. Parking functions can be classified according to the factorization of their nondecreasing reorderings  $\mathbf{a}^\uparrow$  with respect to the operation of shifted concatenation. That is, if

$$(2.5) \quad \mathbf{a}^\uparrow = w_1 \bullet w_2 \bullet \cdots \bullet w_r$$

is the unique maximal factorization of  $\mathbf{a}^\uparrow$ , each  $w_i$  is a nondecreasing prime parking function. Let us define  $i_k = |w_k|$  and let  $I = (i_1, \dots, i_r)$ . We shall say that  $\mathbf{a}$  is of *type*  $I$  and denote by  $\text{PPF}_I$  the set of parking functions of type  $I$ .

Then, the set  $\text{PPF}_n$  of prime parking functions of size  $n$  obviously is a sub-permutation representation of  $\text{PF}_n$ , and it remains to compute its Frobenius characteristic. We prove that it is  $f_n$ , so that  $\Pi_n$  can be identified with  $\text{PPF}_n$ . It is sufficient to show that the number of prime parking functions whose reordered evaluation is a given partition  $\lambda$  is equal to  $\frac{1}{n-1} \binom{n-1}{l(\lambda)} \binom{l(\lambda)}{m_1, m_2, \dots, m_n}$  where  $\lambda = 1^{m_1} 2^{m_2} \cdots n^{m_n}$ . Indeed, this number corresponds to the number of ways of putting the  $\lambda_i$  over  $n - 1$  places in a circle ; there is one circular word associated with each circle whose reading is a prime parking function (see [4]). It then easily comes that

$$(2.6) \quad \text{ch}(\text{PPF}_n) = f_n,$$

so that  $\Pi_n$  can be identified with  $\text{PPF}_n$ , as claimed before.

As a consequence, the set  $\text{PPF}_I$  of parking functions of type  $I$  is a sub-permutation representation of  $\text{PF}_n$  too, and its Frobenius characteristic is

$$(2.7) \quad \text{ch}(\text{PPF}_I) = f_{i_1} \cdots f_{i_r}.$$

Summing over all compositions  $I$  of  $n$  finally gives the right interpretation of Equation (2.4). A more transparent proof is given in Section 3.8.

### 3. A Hopf algebra of parking functions

**3.1. The algebra PQSym.** We can embed the algebra of *Free Quasi-Symmetric functions* **FQSym** of [3] inside the algebra spanned by the elements  $\mathbf{F}_a$  ( $a \in \text{PF}$ ), whose multiplication rule is defined by

$$(3.1) \quad \mathbf{F}_a \mathbf{F}_{a''} := \sum_{a \in a' \uplus a''} \mathbf{F}_a.$$

We shall call this algebra **PQSym** (Parking Quasi-Symmetric functions).

For example,

$$(3.2) \quad \mathbf{F}_{12} \mathbf{F}_{11} = \mathbf{F}_{1233} + \mathbf{F}_{1323} + \mathbf{F}_{1332} + \mathbf{F}_{3123} + \mathbf{F}_{3132} + \mathbf{F}_{3312}.$$

**3.2. The coalgebra PQSym.** There is a comultiplication on **PQSym** that naturally extends the comultiplication of **FQSym**. Recall (see [15, 3]) that if  $\sigma$  is a permutation,

$$(3.3) \quad \Delta \mathbf{F}_\sigma = \sum_{u \cdot v = \sigma} \mathbf{F}_{\text{Std}(u)} \otimes \mathbf{F}_{\text{Std}(v)},$$

where  $\text{Std}$  denotes the usual notion of standardization of a word.

Given a word  $w$ , it is possible to define a notion of *parkization*  $\text{Park}(w)$ , a parking function that coincides with  $\text{Std}(w)$  when  $w$  is a word without repetition.

For  $w = w_1 w_2 \cdots w_n$  on  $\{1, 2, \dots\}$ , let us define

$$(3.4) \quad d(w) := \min\{i \mid \#\{w_j \leq i\} < i\}.$$

If  $d(w) = n + 1$ , then  $w$  is a parking function and the algorithm terminates, returning  $w$ . Otherwise, let  $w'$  be the word obtained by decrementing all the elements of  $w$  greater than  $d(w)$ . Then  $\text{Park}(w) := \text{Park}(w')$ . Since  $w'$  is smaller than  $w$  in the lexicographic order, the algorithm terminates and always returns a parking function.

For example, let  $w = (3, 5, 1, 1, 11, 8, 8, 2)$ . Then  $d(w) = 6$  and  $w' = (3, 5, 1, 1, 10, 7, 7, 2)$ . Then  $d(w') = 6$  and  $w'' = (3, 5, 1, 1, 9, 6, 6, 2)$ . Finally,  $d(w'') = 8$  and  $w''' = (3, 5, 1, 1, 8, 6, 6, 2)$ , that is a parking function. Thus,  $\text{Park}(w) = (3, 5, 1, 1, 8, 6, 6, 2)$ .

Now, the comultiplication on **PQSym** is defined as

$$(3.5) \quad \Delta \mathbf{F}_a := \sum_{u \cdot v = a} \mathbf{F}_{\text{Park}(u)} \otimes \mathbf{F}_{\text{Park}(v)},$$

For example,

$$(3.6) \quad \Delta \mathbf{F}_{3132} = 1 \otimes \mathbf{F}_{3132} + \mathbf{F}_1 \otimes \mathbf{F}_{132} + \mathbf{F}_{21} \otimes \mathbf{F}_{21} + \mathbf{F}_{212} \otimes \mathbf{F}_1 + \mathbf{F}_{3132} \otimes 1.$$

One can easily check that the product and the comultiplication of **PQSym** are compatible, so that **PQSym** is endowed with a bialgebra structure.

**3.3. The Hopf algebra PQSym.** Since **PQSym** is endowed with a bialgebra structure naturally graded by the size of parking functions, one defines the antipode as the inverse of the identity for the convolution product and then endow **PQSym** with a Hopf algebra structure.

The formula for the antipode can be written on the basis of  $\mathbf{F}_a$  functions, as

$$(3.7) \quad \nu(\mathbf{F}_a) = \sum_{r; u_1 \cdots u_r = a; |u_i| \geq 1} (-1)^r \mathbf{F}_{\text{Park}(u_1)} \mathbf{F}_{\text{Park}(u_2)} \cdots \mathbf{F}_{\text{Park}(u_r)}$$

For example,

$$(3.8) \quad \nu(\mathbf{F}_{122}) = -\mathbf{F}_{122} + \mathbf{F}_1 \mathbf{F}_{11} + \mathbf{F}_{12} \mathbf{F}_1 - \mathbf{F}_1^3 = \mathbf{F}_{212} + \mathbf{F}_{221} - \mathbf{F}_{213} - \mathbf{F}_{231} - \mathbf{F}_{321}.$$

**3.4. The graded dual  $\mathbf{PQSym}^*$ .** Let  $\mathbf{G}_a = \mathbf{F}_a^* \in \mathbf{PQSym}^*$  be the dual basis of  $(\mathbf{F}_a)$ . If  $\langle \cdot, \cdot \rangle$  denotes the duality bracket, the product on  $\mathbf{PQSym}^*$  is given by

$$(3.9) \quad \mathbf{G}_{a'} \mathbf{G}_{a''} = \sum_a \langle \mathbf{G}_{a'} \otimes \mathbf{G}_{a''}, \Delta \mathbf{F}_a \rangle \mathbf{G}_a = \sum_{a \in a' * a''} \mathbf{G}_a,$$

where the *convolution*  $a' * a''$  of two parking functions is defined as

$$(3.10) \quad a' * a'' = \sum_{u,v; a=u \cdot v, \text{Park}(u)=a', \text{Park}(v)=a''} a.$$

For example,

$$(3.11) \quad \begin{aligned} \mathbf{G}_{12} \mathbf{G}_{11} &= \mathbf{G}_{1211} + \mathbf{G}_{1222} + \mathbf{G}_{1233} + \mathbf{G}_{1311} + \mathbf{G}_{1322} \\ &+ \mathbf{G}_{1411} + \mathbf{G}_{1422} + \mathbf{G}_{2311} + \mathbf{G}_{2411} + \mathbf{G}_{3411}. \end{aligned}$$

When restricted to permutations, it coincides with the convolution of [19, 15]. Remark that in particular,

$$(3.12) \quad \mathbf{G}_1^n = \sum_{a \in \text{PF}_n} \mathbf{G}_a.$$

Using the duality bracket once more, one easily gets the formula for the comultiplication of  $\mathbf{G}_a$  as

$$(3.13) \quad \Delta \mathbf{G}_a := \sum_{u,v; a \in u \uplus v} \mathbf{G}_{\text{Park}(u)} \otimes \mathbf{G}_{\text{Park}(v)}.$$

There also exists a direct way to define the comultiplication of  $\mathbf{G}_a$  using the breakpoints of Gessel (see [22]). In particular, the number of terms in the coproduct is equal to the number of breakpoints of the parking function plus one.

For example,

$$(3.14) \quad \begin{aligned} \Delta \mathbf{G}_{41252} &= 1 \otimes \mathbf{G}_{41252} + \mathbf{G}_1 \otimes \mathbf{G}_{3141} + \mathbf{G}_{122} \otimes \mathbf{G}_{12} \\ &+ \mathbf{G}_{4122} \otimes \mathbf{G}_1 + \mathbf{G}_{41252} \otimes 1, \end{aligned}$$

whereas 41252 has 4 breakpoints : 1, 3, 4, and 5.

**3.5. Algebraic structure.** Let us say that a word  $w$  over  $\mathbb{N}^*$  is *connected* if it cannot be written as a shifted concatenation  $w = u \bullet v$ , and *anti-connected* if its mirror image  $\bar{w}$  is connected.

Then,  $\mathbf{PQSym}$  is free over the set

$$(3.15) \quad \{\mathbf{F}_c \mid c \in \text{PF}, \text{connected}\}$$

and  $\mathbf{PQSym}^*$  is free over the set

$$(3.16) \quad \{\mathbf{G}_d \mid d \in \text{PF}, \text{anti-connected}\}$$

This property proves that  $\mathbf{PQSym}$  and  $\mathbf{PQSym}^*$  are isomorphic as algebras. Moreover, it is possible to build an isomorphism  $\varphi$  between  $\mathbf{PQSym}$  and  $\mathbf{PQSym}^*$  that is compatible with the product and the comultiplication. So  $\mathbf{PQSym}$  is isomorphic to  $\mathbf{PQSym}^*$  as a *Hopf algebra*.

When restricted to  $\mathbf{FQSym}$ , the isomorphism  $\varphi$  is defined by

$$(3.17) \quad \varphi(\mathbf{F}_\sigma) := \sum_{a, \text{Std}(a)=\sigma^{-1}} \mathbf{G}_a.$$

The ordinary generating function for the numbers  $c_n$  of connected parking functions is

$$\begin{aligned}
 \sum_{n \geq 1} c_n t^n &= 1 - \left( \sum_{n \geq 0} (n+1)^{(n-1)} t^n \right)^{-1} \\
 (3.18) \quad &= t + 2t^2 + 11t^3 + 92t^4 + 1014t^5 + 13795t^6 + 223061t^7 + 4180785t^8 \\
 &+ 89191196t^9 + 2135610879t^{10} + 56749806356t^{11} + 1658094051392t^{12} \\
 &+ O(t^{13}) .
 \end{aligned}$$

**3.6. Multiplicative Bases.** Let  $\mathbf{a} = \mathbf{a}_1 \bullet \mathbf{a}_2 \bullet \dots \bullet \mathbf{a}_r$  be the maximal factorization of  $\mathbf{a}$  into connected parking functions. We set

$$(3.19) \quad \mathbf{F}^{\mathbf{a}} = \mathbf{F}_{\mathbf{a}_1} \cdot \mathbf{F}_{\mathbf{a}_2} \cdots \mathbf{F}_{\mathbf{a}_r} ,$$

and

$$(3.20) \quad \mathbf{G}^{\bar{\mathbf{a}}} = \mathbf{G}_{\bar{\mathbf{a}}_r} \cdots \mathbf{G}_{\bar{\mathbf{a}}_1} .$$

By a triangular argument, one can easily see that  $(\mathbf{F}^{\mathbf{a}})$  (resp.  $(\mathbf{G}^{\bar{\mathbf{a}}})$ ), where  $\mathbf{a}$  runs over the connected parking functions, is a multiplicative basis of  $\mathbf{PQSym}$  (resp.  $\mathbf{PQSym}^*$ ).

Now, if  $\xi_{\mathbf{a}}$  (resp.  $\mathbf{T}_{\mathbf{a}}$ ) is the dual basis of  $\mathbf{F}^{\mathbf{a}}$  (resp.  $\mathbf{G}^{\bar{\mathbf{a}}}$ ) then

$$(3.21) \quad \{\xi_{\mathbf{c}} \mid \mathbf{c} \text{ connected}\} \text{ and } \{\mathbf{T}_{\mathbf{c}} \mid \mathbf{c} \text{ connected}\}$$

are bases of the primitive Lie algebras  $\mathbf{LPQ}^*$  (resp.  $\mathbf{LPQ}$ ) of  $\mathbf{PQSym}^*$  (resp.  $\mathbf{PQSym}$ ).

We conjecture, as in [3], that both Lie algebras are free, on generators whose degree generating function is

$$\begin{aligned}
 1 - \prod_{n \geq 1} (1 - t^n)^{c_n} &= 1 - (1-t)(1-t^2)^2(1-t^3)^{11} \dots \\
 (3.22) \quad &= t + 2t^2 + 9t^3 + 80t^4 + 901t^5 + 12564t^6 + 206476t^7 \\
 &+ 3918025t^8 + 84365187t^9 + 2034559143t^{10} + O(t^{11}) .
 \end{aligned}$$

**3.7. Catalan Hopf algebra (non-crossing partitions).**

3.7.1. *The Hopf algebra  $\mathbf{CQSym}$ .* Parking functions are known to be related to non-crossing partitions (see [2, St, 22]). There is a simple bijection between non-decreasing parking functions and non-crossing partitions. Starting with a non-crossing partition, *e.g.*,

$$(3.23) \quad \pi = 13|2|45 ,$$

one replaces all the letters of each block by its minimum, and reorders them as a non-decreasing word

$$(3.24) \quad 13|2|45 \tilde{\Omega} 11244$$

which is a parking function. In the sequel, we identify non-decreasing parking functions and non-crossing partitions via this bijection.

For a general  $\mathbf{a} \in \mathbf{PF}_n$ , let  $\mathbf{NC}(\mathbf{a})$  be the non-crossing partition corresponding to  $\mathbf{a}^\uparrow$  by the inverse bijection, *e.g.*,  $\mathbf{NC}(42141) = \pi$  as above. Then, the elements of  $\mathbf{PQSym}$

$$(3.25) \quad \mathbf{P}^\pi := \sum_{\mathbf{a}; \mathbf{NC}(\mathbf{a})=\pi} \mathbf{F}_{\mathbf{a}}$$

span a sub-algebra of  $\mathbf{PQSym}$ , isomorphic to the algebra of the free semigroup of non-crossing partitions under the operation of concatenation of diagrams,

$$(3.26) \quad \mathbf{P}^{\pi'} \mathbf{P}^{\pi''} = \mathbf{P}^{\pi' \bullet \pi''} ,$$

that is equivalent to shifted concatenation on words. Notice that  $\mathbf{P}^\pi$  is the sum of all permutations of the non-decreasing word corresponding to the given non-crossing partition. We call this algebra the *Catalan subalgebra* of  $\mathbf{PQSym}$  and denote it by  $\mathbf{CQSym}$ . The comultiplication is given on the basis  $\mathbf{P}^\pi$  by

$$(3.27) \quad \Delta \mathbf{P}^\pi = \sum_{u,v;(u.v)^\dagger = \pi} \mathbf{P}^{\text{Park}(u)} \otimes \mathbf{P}^{\text{Park}(v)},$$

where  $u$  and  $v$  run over the set of non-decreasing words.

For example, one has

$$(3.28) \quad \begin{aligned} \Delta \mathbf{P}^{1124} &= 1 \otimes \mathbf{P}^{1124} + \mathbf{P}^1 \otimes (\mathbf{P}^{112} + \mathbf{P}^{113} + \mathbf{P}^{123}) + \mathbf{P}^{11} \otimes \mathbf{P}^{12} \\ &+ \mathbf{P}^{12} \otimes (\mathbf{P}^{11} + 2\mathbf{P}^{12}) + (\mathbf{P}^{112} + \mathbf{P}^{113} + \mathbf{P}^{123}) \otimes \mathbf{P}^1 + \mathbf{P}^{1124} \otimes 1. \end{aligned}$$

One can easily check that the product and the comultiplication of  $\mathbf{CQSym}$  are compatible, so that  $\mathbf{CQSym}$  is endowed with a graded bialgebra structure, and therefore, with a Hopf algebra structure. Formula (3.27) immediately proves that the coalgebra  $\mathbf{CQSym}$  is co-commutative.

3.7.2. *The dual Hopf algebra  $\mathbf{CQSym}^*$ .* Let us denote by  $\mathcal{M}_\pi$  the dual basis of  $\mathbf{P}^\pi$  in the commutative algebra  $\mathbf{CQSym}^*$ . Remark that  $\mathbf{CQSym}^*$  is the quotient of  $\mathbf{PQSym}^*$  by the relations  $\mathbf{G}_a \equiv \mathbf{G}_b$  if  $a^\dagger = b^\dagger$ . It is then immediate (see Equation (3.9)) that the multiplication in this basis is given by

$$(3.29) \quad \mathcal{M}_{\pi'} \mathcal{M}_{\pi''} = \sum_{\pi; \pi \in \pi' * \pi''} \mathcal{M}_{\pi^\dagger}.$$

For example,

$$(3.30) \quad \begin{aligned} \mathcal{M}_{12} \mathcal{M}_{11} &= \mathcal{M}_{1112} + \mathcal{M}_{1113} + \mathcal{M}_{1114} + \mathcal{M}_{1123} + \mathcal{M}_{1124} \\ &+ \mathcal{M}_{1134} + \mathcal{M}_{1222} + \mathcal{M}_{1223} + \mathcal{M}_{1224} + \mathcal{M}_{1233}. \end{aligned}$$

This algebra can be embedded in the polynomial algebra  $\mathbb{C}[x_1, x_2, \dots]$  by

$$(3.31) \quad \mathcal{M}_\pi = \sum_{\mathbf{a}(w) = \pi} \underline{w},$$

where  $\underline{w}$  is the commutative image of  $w$  (i.e.,  $i \mapsto x_i$ ).

For example,

$$(3.32) \quad \mathcal{M}_{111} = \sum_i x_i^3.$$

$$(3.33) \quad \mathcal{M}_{112} = \sum_i x_i^2 x_{i+1}.$$

$$(3.34) \quad \mathcal{M}_{113} = \sum_{i,j; j \geq i+2} x_i^2 x_j.$$

$$(3.35) \quad \mathcal{M}_{122} = \sum_{i,j; i < j} x_i x_j^2.$$

$$(3.36) \quad \mathcal{M}_{123} = \sum_{i,j,k; i < j < k} x_i x_j x_k.$$

Notice that  $\mathcal{M}_{111} = M_3$ ;  $\mathcal{M}_{112} + \mathcal{M}_{113} = M_{21}$ ;  $\mathcal{M}_{122} = M_{12}$  and  $\mathcal{M}_{123} = M_{111}$ . In general, if  $\pi = \pi_1 \bullet \dots \bullet \pi_r$  is the factorization of  $\pi$  in connected parking functions, let  $i_k := |\pi_k|$  and  $c(\pi) := (i_1, \dots, i_k)$

a composition of  $n$ . Then

$$(3.37) \quad \gamma(M_I) := \sum_{c(\pi)=I} \mathcal{M}_\pi$$

gives an embedding of  $QSym$  into  $\mathbf{CQSym}^*$ .

**3.7.3. Catalan Ribbon functions.** In the classical case, the non-commutative complete functions split into a sum of ribbon Schur functions, using a simple order on compositions. To get an analogous construction in our case, we define a partial order on non-decreasing parking functions.

Let  $\pi$  be a non-decreasing parking function and  $\text{Ev}(\pi)$  be its evaluation vector. The successors of  $\pi$  are the non-decreasing parking functions whose evaluations are given by the following algorithm: given two non-zero elements of  $\text{Ev}(\pi)$  with only zeroes between them, replace the left one by the sum of both and the right one by 0.

For example, the successors of 113346 are 111146, 113336, and 113344.

By transitive closure, the successor map gives rise to a partial order on non-decreasing parking functions. We will write  $\pi \preceq \pi'$  if  $\pi'$  is obtained from  $\pi$  by successive applications of successor maps.

Now, define the Catalan Ribbon functions by

$$(3.38) \quad \mathbf{P}^\pi =: \sum_{\pi' \succeq \pi} \mathbf{R}_{\pi'}.$$

This last equation completely defines the  $\mathbf{R}_\pi$ .

The product of two  $\mathbf{R}$  functions is then

$$(3.39) \quad \mathbf{R}_{\pi'} \mathbf{R}_{\pi''} = \mathbf{R}_{\pi' \bullet \pi''} + \mathbf{R}_{\pi' \triangleright \pi''},$$

where  $\triangleright$  is the shifted concatenation defined by shifting all elements of  $\pi''$  by the difference between the greatest and the smallest element of  $\pi'$ .

For example,

$$(3.40) \quad \mathbf{R}_{11224} \mathbf{R}_{113} = \mathbf{R}_{11224668} + \mathbf{R}_{11224446}.$$

**3.8. Compositions.** Recall that non-crossing partitions can be classified according to the factorization  $\pi = \pi_1 \bullet \cdots \bullet \pi_r$  into irreducible non-crossing partitions. We set

$$(3.41) \quad \mathbf{V}^I := \sum_{c(\pi)=I} \mathbf{P}^\pi$$

as an element of  $\mathbf{PQSym}$ . If one defines  $\mathbf{V}_n = \mathbf{V}^{(n)}$ , we have

$$(3.42) \quad \mathbf{V}_n = \sum_{\mathbf{a} \in \text{PPF}_n} \mathbf{F}_\mathbf{a}$$

and

$$(3.43) \quad \mathbf{V}^I = \mathbf{V}_{i_1} \cdots \mathbf{V}_{i_r} = \sum_{\mathbf{a} \in \text{PPF}_I} \mathbf{F}_\mathbf{a}.$$

At this point, it is useful to observe that if  $C(w)$  denotes the descent composition of a word  $w$ , the map

$$(3.44) \quad \eta : \mathbf{F}_\mathbf{a} \mapsto F_{C(\mathbf{a})},$$

which is a Hopf algebra morphism  $\mathbf{PQSym} \tilde{\Omega} QSym$ , maps  $\mathbf{V}^I$  to the Frobenius characteristic of the underlying permutation representation of  $\mathfrak{S}_n$  on  $\text{PPF}_I$ .

$$(3.45) \quad \eta(\mathbf{V}^I) = \sum_{\mathbf{a} \in \text{PPF}_I} \mathbf{F}_{C(\mathbf{a})} = \text{ch}(\text{PPF}_I).$$

As a consequence, the number of parking functions of type  $I$  with descent set  $J$  is equal to the scalar product of symmetric functions

$$(3.46) \quad \langle r_J, f^I \rangle$$

where  $f^I = f_{i_1} \cdots f_{i_r} = \text{ch}(\text{PPF}_I)$  and  $r_J$  is the ribbon Schur function. This extends Prop. 3.2.(a) of [21]. Remark that in particular,

$$(3.47) \quad \mathbf{F}_{\text{PF}_n} := \sum_{\mathbf{a} \in \text{PF}_n} \mathbf{F}_{\mathbf{a}} = \sum_{I \models n} \mathbf{V}^I,$$

a realisation of Equation (2.4) as an identity in  $\mathbf{PQSym}$ . By inversion, one obtains

$$(3.48) \quad \mathbf{F}_{\text{PPF}_n} = \sum_{I \models n} (-1)^{n-l(I)} \mathbf{F}_{\text{PF}_I},$$

where

$$(3.49) \quad \text{PF}_I := \text{PF}_{i_1} \uplus \text{PF}_{i_2} \uplus \cdots \uplus \text{PF}_{i_r}.$$

These identities are easily visualized on the encoding of parking functions with skew Young diagrams as in [17] or in [7].

The transpose  $\gamma^*$  of the map  $\gamma$  defined in Equation (3.37), is the map

$$(3.50) \quad \begin{aligned} \text{ch} : \mathbf{CQSym}^* \tilde{\Omega}\mathbf{Sym} \\ \mathbf{P}^\pi \mapsto S^c(\pi). \end{aligned}$$

which sends  $\mathbf{P}^\pi$  to the characteristic non-commutative symmetric function of the natural projective  $H_n(0)$ -module with basis  $\{\mathbf{a} \in \text{PF}_n \mid \text{NC}(\mathbf{a}) = \pi\}$ .

Then,

$$(3.51) \quad g := \sum_{n \geq 0} g_n := \sum_{n \geq 0} \text{ch}(\mathbf{F}_{\text{PF}_n}) = \sum_I \text{ch}(\mathbf{V}^I).$$

is the series obtained by applying the non-commutative Lagrange inversion formula of [6, 18] to the generating series of complete functions, *i.e.*,  $g$  is the unique solution of the equation

$$(3.52) \quad g = 1 + S_1 g + S_2 g^2 + \cdots = \sum_{n \geq 0} S_n g^n.$$

**3.9. Schröder Hopf algebra (planar trees).** Let  $\equiv$  denote the hypoplactic congruence (see [11, 16]), and denote by  $P(w)$  the hypoplactic  $P$ -symbol of a word  $w$  (its quasi-ribbon).  $P$ -symbols of parking functions are called *parking quasi-ribbons*.

With a parking quasi-ribbon  $\mathbf{q}$ , we associate the element

$$(3.53) \quad \mathbf{P}_{\mathbf{q}} := \sum_{P(\mathbf{a})=\mathbf{q}} \mathbf{F}_{\mathbf{a}}.$$

Then, the  $\mathbf{P}_{\mathbf{q}}$  form the basis of a Hopf sub-algebra of  $\mathbf{PQSym}$ , denoted by  $\mathbf{SQSym}$ . Its dual  $\mathbf{SQSym}^*$  is the quotient  $\mathbf{PQSym}/\mathcal{J}$  where  $\mathcal{J}$  is the two-sided ideal generated by

$$(3.54) \quad \{\mathbf{G}_{\mathbf{a}} - \mathbf{G}_{\mathbf{a}'} \mid \mathbf{a} \equiv \mathbf{a}'\}.$$

If  $\overline{\mathbf{G}_{\mathbf{a}}}$  denoted the equivalence class of  $\mathbf{G}_{\mathbf{a}}$  modulo  $\mathcal{J}$ , the dual basis of  $(\mathbf{P}_{\mathbf{q}})$  is

$$(3.55) \quad \mathbf{Q}_{\mathbf{q}} := \overline{\mathbf{G}_{\mathbf{a}}},$$

where  $\mathbf{a}$  is any parking function such that  $\mathbf{a} \equiv \mathbf{q}$ .

The dimension of the component of degree  $n$  of  $\mathbf{SQSym}$  and  $\mathbf{SQSym}^*$  is the little Schröder number (or super-Catalan)  $s_n$  : their Hilbert series is

$$(3.56) \quad \sum_{n \geq 0} s_n t^n = \frac{1+t-\sqrt{1-6t+t^2}}{4t} = 1+t+3t^2+11t^3+45t^4+\dots$$

Indeed,

$$(3.57) \quad \begin{aligned} \dim(\mathbf{SQSym}_n) &= \left\langle \sum_{I \models n} F_I, \mathbf{ch}(\mathbf{F}_{\mathbf{PF}_n}) \right\rangle \\ &= \left\langle \frac{1}{2} \sum_{k=0}^n e_k h_{n-k}, \frac{1}{n+1} h_n((n+1)X) \right\rangle \\ &= \frac{1}{2n+2} \sum_{k=0}^n \binom{n+1}{k} \binom{2n-k}{n-k} = s_n. \end{aligned}$$

The embedding of Formula (3.17) induces an embedding

$$(3.58) \quad QSym \simeq \mathbf{FQSym}^*/(\mathcal{J} \cap \mathbf{FQSym}^*) \rightarrow \mathbf{PQSym}^*/\mathcal{J} = \mathbf{SQSym}^*.$$

It is likely that  $\mathbf{SQSym}$  is isomorphic to the free dendriform trialgebra of [13] as an algebra, but not as a coalgebra.

**3.10.  $\mathbf{PQSym}^*$  as a combinatorial Hopf algebra.** Since  $\mathbf{FQSym}$  can be embedded in  $\mathbf{PQSym}$ , we have a canonical Hopf embedding of  $\mathbf{Sym}$  in  $\mathbf{PQSym}$  given by

$$(3.59) \quad S_n \mapsto \mathbf{F}_{12\dots n}.$$

With parking functions, we have other possibilities: for example,

$$(3.60) \quad j(S_n) := \mathbf{F}_{11\dots 1}$$

is a Hopf embedding, whose dual  $j^*$  maps  $\mathbf{PQSym}^*$  to  $QSym$  and therefore endows  $\mathbf{PQSym}^*$  with a different structure of combinatorial Hopf algebra in the sense of [1].

On the dual side, the transpose  $\eta^*$  of the map  $\eta$  defined in the previous section corresponds to the Hopf embedding

$$(3.61) \quad S_n \mapsto \sum_{\text{Std}(\mathbf{a})=12\dots n} \mathbf{G}_{\mathbf{a}}$$

of  $\mathbf{Sym}$  into  $\mathbf{PQSym}^*$ , which is therefore the restriction of the self-duality isomorphism of formula (3.17) to the  $\mathbf{Sym}$  subalgebra  $S_n = \mathbf{F}_{12\dots n}$  of  $\mathbf{PQSym}$ .

#### 4. Realization of $\mathbf{PQSym}$

It is possible to find a realization of  $\mathbf{PQSym}$  in terms of  $(0,1)$ -matrices, that is reminiscent of the construction of  $\mathbf{MQSym}$  (see [9, 3]), and that coincides with it when restricted to permutation matrices, providing the natural embedding of  $\mathbf{FQSym}$  in  $\mathbf{MQSym}$ .

Let  $\mathcal{M}_n$  be the vector space spanned by symbols  $X_M$  where  $M$  runs over  $(0,1)$ -matrices with  $n$  columns and an infinite number of rows, with  $n$  nonzero entries, so that at most  $n$  rows are nonzero.

Given such a matrix  $M$ , we define its *vertical packing*  $P = \text{vp}(M)$  as the finite matrix obtained by removing the null rows of  $M$ .

For a vertically packed matrix  $P$ , we define

$$(4.1) \quad \mathbf{M}_P = \sum_{\text{vp}(M)=P} X_M.$$



Now, given a  $(0, 1)$ -matrix, we define its reading  $r(M)$  as the word obtained by reading its entries by rows, from left to right and top to bottom and recording the numbers of the columns of the ones. For example, the reading of the matrix

$$(4.2) \quad \begin{pmatrix} 0110 \\ 1000 \\ 0100 \end{pmatrix}$$

is  $(2, 3, 1, 2)$ .

A matrix  $M$  is said to be of *parking type* if  $r(M)$  is a parking function. Finally, for a parking function  $\mathbf{a}$ , we set

$$(4.3) \quad \mathbf{F}_{\mathbf{a}} := \sum_{r(P)=\mathbf{a}, P \text{ vertically packed}} \mathbf{M}_P = \sum_{r(M)=\mathbf{a}} X_M.$$

For example,

$$(4.4) \quad \mathbf{F}_{(1,2,2)} = \mathbf{M} \begin{pmatrix} 1110 \\ 0110 \end{pmatrix} + \mathbf{M} \begin{pmatrix} 100 \\ 010 \\ 010 \end{pmatrix}.$$

The multiplication on  $\mathcal{M} = \oplus_n \mathcal{M}_n$  is defined by columnwise concatenation of the matrices:

$$(4.5) \quad X_M X_N = X_{M \cdot N}.$$

In order to explicit the product of  $\mathbf{M}_P$  by  $\mathbf{M}_Q$ , we first need a definition. Let  $P$  and  $Q$  be two vertically packed matrices with respective heights  $p$  and  $q$ . The *augmented shuffle* of  $P$  and  $Q$  is defined as follows: let  $r$  be an integer in  $[\max(p, q), p + q]$ . One inserts zero rows in  $P$  and  $Q$  in all possible ways so that the resulting matrices have  $p + q$  rows. Let  $R$  be the matrix obtained by concatenation of such pairs of matrices. The augmented shuffle consists in the set of such matrices  $R$  with nonzero rows. We denote this set by  $\uplus(P, Q)$ .

With this notation,

$$(4.6) \quad \mathbf{M}_P \mathbf{M}_Q = \sum_{R \in \uplus(P, Q)} \mathbf{M}_R,$$

and also

$$(4.7) \quad \mathbf{F}_{\mathbf{a}'} \mathbf{F}_{\mathbf{a}''} = \sum_{\mathbf{a} \in \mathbf{a}' \uplus \mathbf{a}''} \mathbf{F}_{\mathbf{a}},$$

that is the same as Equation (3.1).

Finally, concerning the comultiplication, one has first to define the parkization  $\text{Park}(M)$  of a vertically packed matrix  $M$ , which consists in iteratively removing column  $d(r(M))$  until  $M$  becomes a parking matrix.

The comultiplication of a matrix  $\mathbf{M}_P$  is then defined as:

$$(4.8) \quad \Delta \mathbf{M}_P = \sum_{Q \cdot R = P} \mathbf{M}_{\text{Park}(Q)} \otimes \mathbf{M}_{\text{Park}(R)},$$

It is then easy to check that

$$(4.9) \quad \Delta \mathbf{F}_{\mathbf{a}} = \sum_{u \cdot v = \mathbf{a}} \mathbf{F}_{\text{Park}(u)} \otimes \mathbf{F}_{\text{Park}(v)},$$

which is the same as Equation (3.3).

**4.1. Realization of  $\mathbf{FQSym}$ .** A parking matrix  $M$  is said to be a *word matrix* if there is exactly one 1 in each column. Then  $\mathbf{FQSym}$  is the Hopf subalgebra generated by the parking word matrices.

## References

- [1] M. AGUIAR, N. BERGERON, and F. SOTTILE, *Combinatorial Hopf Algebra and generalized Dehn-Sommerville relations*, preprint math.CO/0310016.
- [2] P. BIANE, *Parking functions of types A and B*, Electronic J. Combin. **9** (2002), # 7.
- [3] G. DUCHAMP, F. HIVERT, and J.-Y. THIBON, *Noncommutative symmetric functions VI: free quasi-symmetric functions and related algebras*, Internat. J. Alg. Comput. **12** (2002), 671–717.
- [4] A. DVORETZKY and T. MOTZKIN, *A problem of arrangements*, Duke Math. J. **14** (1947), 303–313.
- [5] I.M. GELFAND, D. KROB, A. LASCoux, B. LECLERC, V. S. RETAKH, and J.-Y. THIBON, *Noncommutative symmetric functions*, Adv. in Math. **112** (1995), 218–348.
- [6] I. GESSEL, *Noncommutative Generalization and  $q$ -analog of the Lagrange Inversion Formula*, Trans. Amer. Math. Soc. **257** (1980), no. 2, 455–482.
- [7] J. HAGLUND, M. HAIMAN, N. LOEHR, J. B. REMMEL, and A. ULYANOV, *A combinatorial formula for the character of the diagonal coinvariants*, preprint, 2003, math.CO/0310414.
- [8] M. HAIMAN, *Conjectures on the quotient ring by diagonal invariants*, J. Alg. Combin. **3** (1994), 17–76.
- [9] F. HIVERT, *Combinatoire des fonctions quasi-symétriques*, Thèse de Doctorat, Marne-La-Vallée, 1999.
- [10] L. H. KALIKOW, *Enumeration of parking functions, allowable permutation pairs, and labelled trees*, Ph. D. Thesis, Brandeis University, 1999.
- [11] D. KROB and J.-Y. THIBON, *Noncommutative symmetric functions IV: Quantum linear groups and Hecke algebras at  $q = 0$* , J. Alg. Comb. **6** (1997), 339–376.
- [12] C. LENART, *Lagrange inversion and Schur functions*, J. Algebraic Combin. **11** (2000), 1, 69–78.
- [13] J.-L. LODAY and M. O. RONCO, *Trialgebras and families of polytopes*, preprint math.AT/0205043.
- [14] I.G. MACDONALD, *Symmetric functions and Hall polynomials*, 2nd ed., Oxford University Press, 1995.
- [15] C. MALVENUTO and C. REUTENAUER, *Duality between quasi-symmetric functions and the Solomon descent algebra*, J. Algebra **177** (1995), 967–982.
- [16] J.-C. NOVELLI, *On the hypoplactic monoid*, Disc. Math. **217**, 2000, 315–336.
- [17] I. PAK and A. POSTNIKOV, *Enumeration of trees and one amazing representation of  $S_n$* , Proc. FPSAC'96 Conf., Minneapolis, MN, 1996, 385–389.
- [18] I. PAK, A. POSTNIKOV, and V. S. RETAKH, *Noncommutative Lagrange Theorem and Inversion Polynomials*, preprint, 1995, available at <http://www-math.mit.edu/~pak/research.html>.
- [19] C. REUTENAUER, *Free Lie algebras*, Oxford University Press, 1993.
- [20] R. SPEICHER, *Multiplicative functions on the lattice on non-crossing partitions and free convolution*, Math. Annalen **298** (1994), 141–159.
- [21] R. P. STANLEY, *Parking functions and noncrossing partitions*, Electronic J. Combin. **4** (1997), # 2.
- [22] R. P. STANLEY, *Enumerative combinatorics*, vol. 2, Cambridge University Press, 1999.

INSTITUT GASPARD MONGE, UNIVERSITÉ DE MARNE-LA-VALLÉE, 5 BOULEVARD DESCARTES, CHAMPS-SUR-MARNE, 77454  
 MARNE-LA-VALLÉE CEDEX 2, FRANCE  
 E-mail address: novelli@univ-mlv.fr

INSTITUT GASPARD MONGE, UNIVERSITÉ DE MARNE-LA-VALLÉE, 5 BOULEVARD DESCARTES, CHAMPS-SUR-MARNE, 77454  
 MARNE-LA-VALLÉE CEDEX 2, FRANCE  
 E-mail address: jyt@univ-mlv.fr

## An Arctic Circle Theorem For Groves

T. Kyle Petersen and David Speyer

**Abstract.** In earlier work, Jockusch, Propp, and Shor proved a theorem describing the limiting shape of the boundary between the uniformly tiled corners of a random tiling of an Aztec diamond and the more unpredictable ‘temperate zone’ in the interior of the region. The so-called arctic circle theorem made precise a phenomenon observed in random tilings of large Aztec diamonds.

Here we examine a related combinatorial model called groves. Created by Carroll and Speyer as combinatorial interpretations for Laurent polynomials given by the cube recurrence, groves have observable frozen regions which we describe precisely via asymptotic analysis of generating functions, in the spirit of Pemantle and Wilson. Our methods also provide another way to prove the arctic circle theorem for Aztec diamonds.

**Résumé.** Dans leurs travaux, Jockusch, Propp, et Shor ont prouvé un théorème décrivant la forme limite de la frontière entre les coins uniformément pavés (“gelés”) d’un pavage aléatoire d’un diamant aztèque et la zone “temperee” moins prévisible à l’intérieur du diamant. Le théorème du cercle arctique a rendu précis un phénomène observé dans les pavages aléatoires de grands diamants aztèques.

Nous examinons un modèle combinatoire relie appelé les bosquets. Créé par Carroll et Speyer en tant qu’interprétation combinatoires pour des polynômes de Laurent donnés par la récurrence du cube, les bosquets laissent apparaître des régions gelées que nous décrivons avec précision par l’intermédiaire de l’analyse asymptotique de fonctions génératrices, dans l’esprit de Pemantle et de Wilson. Nos méthodes fournissent également une autre manière de prouver le théorème du cercle arctique pour les diamants aztèques.

### 1. Introduction

Groves came into existence as combinatorial interpretations of rational functions generated by the *cube recurrence*:

$$f_{i,j,k}f_{i-1,j-1,k-1} = f_{i-1,j,k}f_{i,j-1,k-1} + f_{i,j-1,k}f_{i-1,j,k-1} + f_{i,j,k-1}f_{i-1,j-1,k},$$

where some initial functions are specified. Typically,  $f_{i,j,k} := x_{i,j,k}$  for some choice of  $(i, j, k) \in \mathbb{Z}^3$  called the *initial conditions*. Fomin and Zelevinsky [FZ] were able to show that for arbitrary initial conditions the rational functions generated by the cube recurrence were in fact Laurent polynomials in the  $x_{i,j,k}$ . The introduction of groves by Carroll and Speyer [CS] gave a combinatorial proof of the surprising fact that each

---

1991 *Mathematics Subject Classification*. Primary 05A16, 60C05; Secondary 05E99, 82B20.

*Key words and phrases*. groves, cube recurrence, arctic circle theorem.

term of these polynomials has coefficient  $+1$ . In this paper we will only examine the family of groves on *standard initial conditions* as described in Section 1.1.<sup>1</sup>

Before getting into the details of groves, let us first describe the motivation for this paper: random domino tilings of large Aztec diamonds. An Aztec diamond of order  $n$  consists of the union of all unit squares with integer vertices contained in the planar region  $\{(x, y) \mid |x| + |y| \leq n + 1\}$ . A *domino tiling* of an Aztec diamond is an arrangement of  $2 \times 1$  rectangles, or *dominoes*, that cover the diamond without any overlapping. A random domino tiling of a large Aztec diamond consists of two qualitatively different regions.<sup>2</sup> As seen in the random tiling in Figure 1, the dominoes in the corners of the diamond are *frozen* in a brickwork pattern, whereas the dominoes in the interior have a more random, *temperate* behavior. It was shown in [JPS] and [CEP] that asymptotically, the boundary between the frozen and temperate regions in a random tiling is given by the circle inscribed in the Aztec diamond. Since everything outside the circle is expected to be frozen, it is referred to as the *arctic circle*.

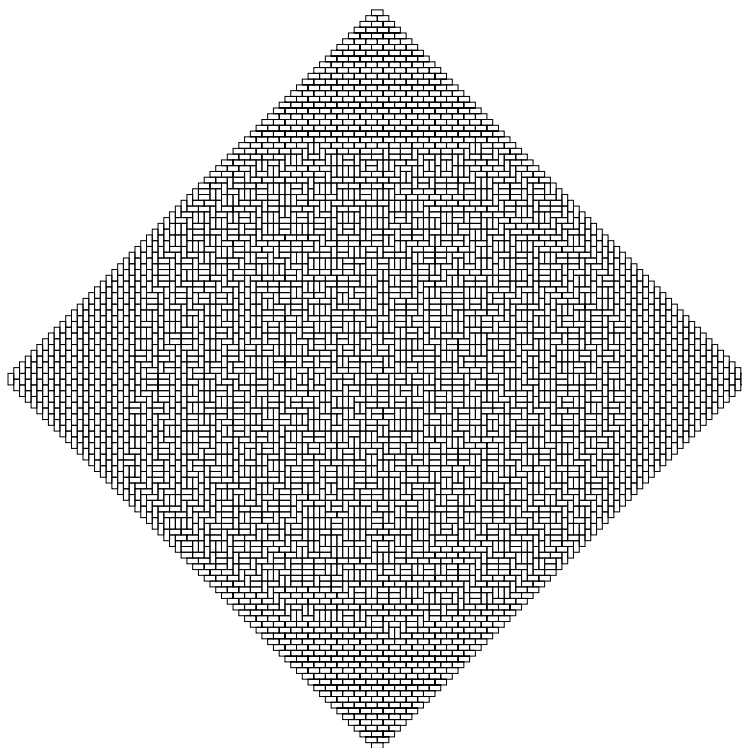

FIGURE 1. A random domino tiling of an Aztec diamond of order 64

In this paper we shall see that groves on standard initial conditions exhibit a very similar behavior. A grove, however, is not a type of tiling. In fact, as the name may suggest, a grove is a collection of trees. From our point of view, groves are forests on a triangular lattice satisfying certain connectivity conditions on the boundary. We will show that outside of the circle inscribed in the triangle, the trees of a large random grove line up uniformly.

---

<sup>1</sup>Herein we will invoke some of the basic properties of groves without proof. For such arguments, as well as a general treatment of groves and the cube recurrence, the reader is referred to [CS].

<sup>2</sup>By random we mean selected from the uniform distribution on all tilings of an Aztec diamond of order  $n$ , though other probability distributions may be considered as well. See [CEP].

Despite their superficial differences, groves and random domino tilings of Aztec diamonds are linked by more than their asymptotic behavior. In fact it seems that their asymptotic behavior is similar *because* they share a deeper link. The paper of Carroll and Speyer [CS] establishes that groves are encoded in terms of a Laurent polynomial given by the cube recurrence. There is a more general form of the cube recurrence:

$$f_{i,j,k}f_{i-1,j-1,k-1} = \alpha f_{i-1,j,k}f_{i,j-1,k-1} + \beta f_{i,j-1,k}f_{i-1,j,k-1} + \gamma f_{i,j,k-1}f_{i-1,j-1,k},$$

where  $\alpha, \beta, \gamma$  are constants. If  $\alpha = \beta = \gamma = 1$  we have the original form of the cube recurrence from whence come groves. If  $\alpha = \beta = 1$  and  $\gamma = 0$ , we have (after re-indexing), the *octahedron recurrence*:

$$g_{i,j,n+1}g_{i,j,n-1} = g_{i-1,j,n}g_{i+1,j,n} + g_{i,j-1,n}g_{i,j+1,n},$$

with which we may encode tilings of Aztec diamonds. In Section 3, we will describe the role that this recurrence plays in the large scale behavior of such tilings.

While the octahedron recurrence is important to us, it has not played a significant role in the study of tilings of Aztec diamonds in the past. Rather, a local move called *domino shuffling* has been used. Domino shuffling was introduced in [EKLP] and is generalized in [P]. It provides a method for generating tilings of successively larger Aztec diamonds uniformly at random, and has been at least implicit in all probabilistic analysis done to date. Section 1.3 will introduce an analogous local move for groves that we call *grove shuffling*. Like domino shuffling, it will be key to our analysis.

For each of the two models discussed we have a global perspective and a local perspective. Laurent polynomials tell the global story: all groves are encapsulated in  $f_{0,0,0}$  (from the cube recurrence), all tilings in  $g_{0,0,n}$  (from the octahedron recurrence). A specified shuffling algorithm tells the local story. In this paper we combine these two points of view to build generating functions (for tilings of Aztec diamonds as well as for groves), with which we can study asymptotic behavior.

**1.1. Groves on standard initial conditions.** The standard initial conditions of order  $n$  specify a vertex set  $\mathcal{I}(n) = \mathcal{C}(n) \cup \mathcal{B}(n)$  where  $\mathcal{C}(n) = \{(i, j, k) \in \mathbb{Z}^3 \mid -n - 1 \leq i + j + k \leq -n + 1, i, j, k \leq 0\}$  and  $\mathcal{B}(n) = \{(i, j, k) \in \mathbb{Z}^3 \mid i + j + k < -n - 1; i, j, k \leq 0; \text{ and } i, j, \text{ or } k = 0\}$ . We draw its projection onto the plane  $\mathbb{R}^3/(1, 1, 1)$  as shown in Figure 2 for the case  $n = 2$ , and in Figure 4 for the case  $n = 5$ . One way to generate all groves of order  $n$  is to set  $f_{i,j,k} := x_{i,j,k}$  for all  $(i, j, k) \in \mathcal{I}(n)$ , and compute  $f_{0,0,0}$ . Each term in the resulting Laurent polynomial defines a grove as follows. Let  $\mathcal{G}(n)$  be the graph on the vertex set  $\mathcal{I}(n)$  where vertex  $(i, j, k)$  has as its neighbors the vertices  $\mathcal{I}(n) \cap \{(i \pm 1, j \pm 1, k), (i \pm 1, j, k \pm 1), (i, j \pm 1, k \pm 1)\}$ . Pictorially, edges of  $\mathcal{G}(n)$  connect vertices that lie diagonally across a rhombus.

The terms in  $f_{0,0,0}$  are Laurent monomials of the form

$$m(g) = \prod_{(i,j,k) \in \mathcal{I}(n)} x_{i,j,k}^{\deg(i,j,k)-2}.$$

We have the following

**Definition 1.1.** The *grove*  $g$  defined by  $m(g)$  is the unique subgraph of  $\mathcal{G}(n)$  containing no crossing edges such that vertex  $(i, j, k)$  in  $\mathcal{I}(n)$  has exactly  $\deg(i, j, k)$  incident edges.

The uniqueness of the grove is a consequence of Theorem 3 in [CS]. For example,  $f_{0,0,0}$  on  $\mathcal{I}(2)$  is

$$\frac{x_{-1,-1,0}x_{0,0,-1}}{x_{-1,-1,-1}} + \frac{x_{-1,0,-1}x_{0,-1,0}}{x_{-1,-1,-1}} + \frac{x_{0,-1,-1}x_{-1,0,0}}{x_{-1,-1,-1}},$$

and the corresponding groves are shown in Figure 3.

For a more interesting example, one term of  $f_{0,0,0}$  on  $\mathcal{I}(5)$  is

$$\frac{x_{-3,0,-2}x_{-2,-1,-1}x_{-1,-3,0}x_{0,-2,-2}}{x_{-3,-1,-2}x_{-2,-3,-1}x_{-1,-2,-2}}.$$

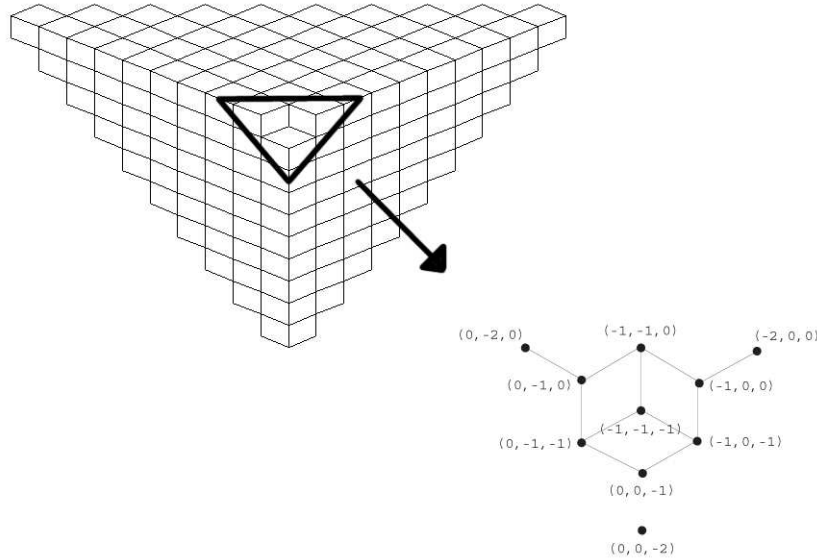

FIGURE 2. Part of the standard initial conditions of order 2

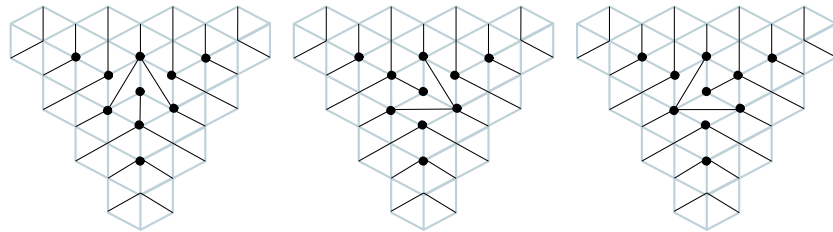

FIGURE 3. The three groves of order 2.

Its corresponding grove,  $g$ , is shown in Figure 4. This grove has interesting connectivity properties; in fact these properties are what distinguish groves from arbitrary subgraphs of  $\mathcal{G}(n)$ . Every vertex on the boundary of  $\mathcal{C}(n)$  (where cubes have been pushed down) is connected to another vertex on the boundary of  $\mathcal{C}(n)$  if and only if those vertices are equidistant to the nearest corner (i.e. where two coordinates are zero) of the grove. Groves are acyclic — every connected component of a grove is a tree.

Notice that there are two types of edges: *long* edges and *short* edges, depending on whether the long or short diagonal of a rhombus is used. It is shown in [CS] that every vertex in  $\mathcal{B}(n)$  has degree 2 and only uses its short edges. As a result, there are only finitely many long edges, and these determine the grove. This observation leads to a more convenient way of looking at groves.

**1.2. Simplified groves.** We begin by constructing a modified form of the cube recurrence. Let  $a_{i,j}$ ,  $b_{k,j}$ ,  $c_{i,k}$  be *long edge variables*. The variable  $a_{i,j}$  is the label for the edge between vertices  $(i, j - 1, k + 1)$  and  $(i - 1, j, k + 1)$ ,  $b_{k,j}$  is the label for the edge between  $(i - 1, j, k + 1)$  and  $(i, j, k)$ , and  $c_{i,k}$  is the label for the edge between  $(i, j, k)$  and  $(i, j - 1, k + 1)$ . We write a modified form of the cube recurrence as follows:

$$f_{i,j,k}f_{i-1,j-1,k-1} = b_{i,k}c_{i,j}f_{i-1,j,k}f_{i,j-1,k-1} + c_{i,j}a_{j,k}f_{i,j-1,k}f_{i-1,j,k-1} + a_{j,k}b_{i,k}f_{i,j,k-1}f_{i-1,j-1,k}.$$

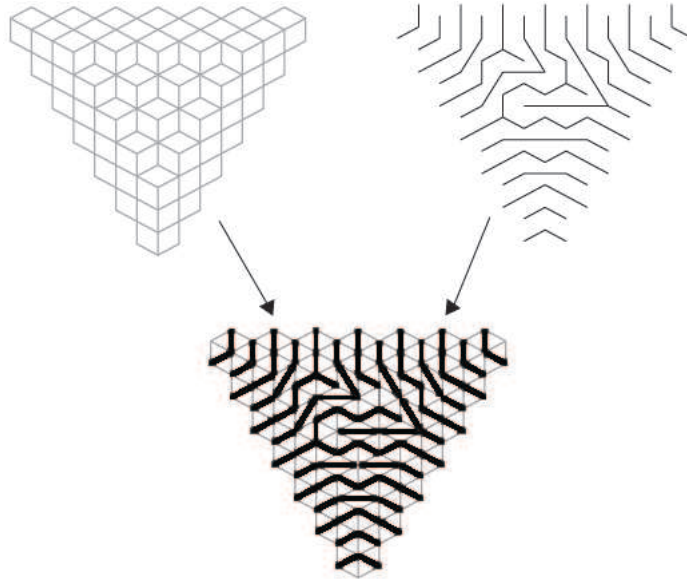

FIGURE 4. A grove  $g$  of order 4, superimposed on  $\mathcal{I}(4)$

As we said, the long edges determine the grove, so rather than setting  $f_{i,j,k} := x_{i,j,k}$  for  $(i, j, k) \in \mathcal{I}(n)$ , we set  $f_{i,j,k} := 1$  for  $(i, j, k) \in \mathcal{I}(n)$ . Then  $f_{0,0,0}$  is simply a polynomial in the edge variables  $a_{i,j}, b_{i,j}, c_{i,j}$ . Each term describes a unique grove, and we still produce every grove. This form of the cube recurrence is called the *edge variables version*. We can draw a simpler picture of our groves by ignoring all short edges and all of the vertices incident with them. In other words, specify a subset of the standard initial conditions of order  $n$ , called the *simplified initial conditions*:  $\mathcal{I}'(n) = \{(i, j, k) \in \mathbf{Z}^3 \mid i + j + k = -n, i, j, k \leq 0\} \subset \mathcal{I}(n)$ . We now represent our groves as graphs on this vertex set – a triangular lattice shown in Figure 5. Also in Figure 5 we see the same grove as in Figure 4, but with only the long edges included. In terms of edge variables, this grove is given by

$$a_{0,0}a_{0,1}a_{0,2}a_{1,0}a_{1,1}a_{2,1}b_{0,0}b_{0,1}c_{0,0}c_{0,1}c_{1,0}c_{2,0}.$$

Another modification of the cube recurrence that we shall like to use is the *edge-and-face variables version*. In the original version of the cube recurrence, the variables  $x_{i,j,k}$  such that  $i + j + k = -n + 1$  were vertex variables. In the simplified picture, we call them the *face variables* of order  $n$ , for reasons which will become clear. Rather than setting  $f_{i,j,k} := 1$  for all  $(i, j, k)$  in  $\mathcal{I}(n)$ , we give the face variables their formal weights. That is, we set  $f_{i,j,k} := 1$  for  $(i, j, k) \in \{(i, j, k) \in \mathbf{Z}^3 \mid -n - 1 \leq i + j + k \leq n, i, j, k \leq 0\}$  and  $f_{i,j,k} := x_{i,j,k}$  for  $(i, j, k) \in \{(i, j, k) \in \mathbf{Z}^3 \mid i + j + k = -n + 1, i, j, k \leq 0\}$ . Generating  $f_{0,0,0}$  using these initial conditions, we get a Laurent polynomial in the edge and face variables. The vertices of the simplified initial conditions can be seen as forming  $n(n + 1)/2$  downward-pointing equilateral triangles, each with top-left vertex  $(i, j - 1, k + 1)$ , top-right vertex  $(i - 1, j, k + 1)$ , and bottom vertex  $(i, j, k)$ . The face variables then correspond to each of these downward-pointing triangles. The triangle with  $(i, j, k)$  as its bottom vertex has face variable  $x_{i,j,k+1}$ . The exponent of the face variable is  $-1, 0$ , or  $1$ , corresponding to whether the downward-pointing triangle has, respectively, two, one, or zero edges present. Although the face variables don't tell us anything new about a particular grove, they will be useful later in deriving probabilities of edges being present in random groves.

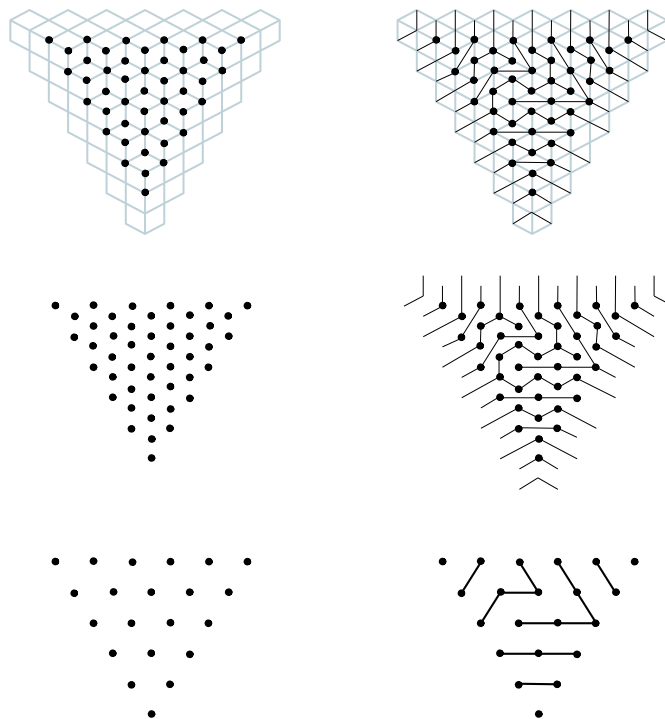

FIGURE 5. On the left:  $\mathcal{I}'(4)$  drawn from  $\mathcal{I}(4)$ . On the right: a simplified grove drawn from a standard grove.

**1.3. Grove shuffling.** We have given one definition for what groves are, and how they may be generated. The methods and notation introduced in the previous section will be very helpful for later proofs. However, there is another tool we will like to use; an algorithm called *grove shuffling* (or *cube-popping* – see [CS]). Grove shuffling not only gives a purely combinatorial definition of groves, but also a method for generating groves of order  $n$  uniformly at random. Its inspiration comes from *domino shuffling*, due to Elkies, Kuperberg, Larsen, and Propp [EKLP]. The use to which we put grove shuffling is directly motivated by Jim Propp and his paper [P]. For proof that grove shuffling does indeed give rise to the same objects as the terms of the Laurent polynomials given by the cube recurrence, see Carroll and Speyer [CS]. Here we will only include a description of the algorithm.

Grove shuffling can be thought of as a local move on the downward-pointing triangles of a simplified grove according to whether a triangle has zero, one, or two edges present. See Figure 6. Let  $x$  be a generic downward-pointing triangle with possible edges  $a, b, c$  as shown, and let  $x'$  be an upward-pointing triangle, concentric with  $x$ , with possible edges  $a', b', c'$  as shown. There are three configurations of  $x$  with two edges:  $ab, ac, bc$ . Grove shuffling takes each of these triangles and replaces them with an upward-pointing triangle  $x'$  having none of its possible edges present. There are three configurations of  $x$  with exactly one edge:  $a, b, c$ . Each of these is replaced by the upward-pointing triangle  $x'$  with only the parallel edge:  $a', b', c'$ , respectively present. Lastly, there is one configuration of  $x$  with none of its possible edges present. This triangle is replaced with the upward-pointing triangle  $x'$  containing any two of its three possible edges:  $a'b', a'c', b'c'$ , chosen randomly with probability  $1/3$ . After we have turned every downward-pointing triangle



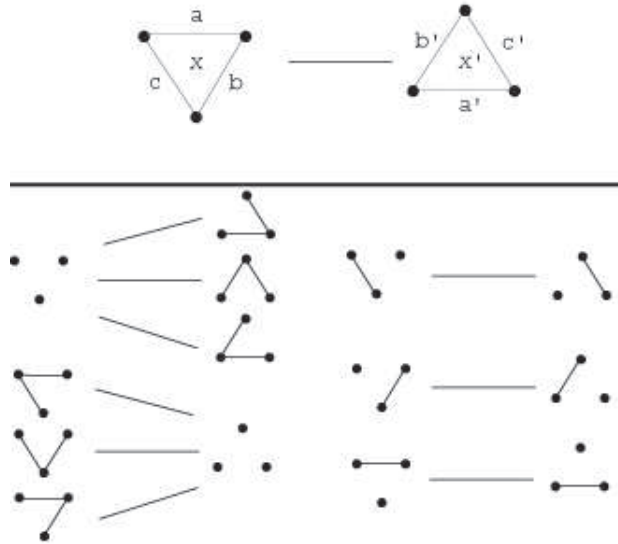

FIGURE 6. Grove shuffling.

into an upward-pointing triangle, we add three new vertices to the corners of the grove so that we may shuffle again.<sup>3</sup>

There is a unique grove of order 1. It has one downward-pointing triangle with zero edges. We now give a purely combinatorial description of simplified groves on standard initial conditions of order  $n$ : they are all the possible results of  $n - 1$  iterations of grove shuffling, beginning with the grove of order 1. It is not hard to show that there are  $3^{\lfloor n^2/4 \rfloor}$  groves of order  $n$ . We can now make the following claim about grove shuffling.

**Theorem 1.2.** *Beginning with the unique grove of order one, any grove of order  $n$  will be generated after  $n - 1$  iterations of grove shuffling with probability  $1/3^{\lfloor n^2/4 \rfloor}$ . In other words, grove shuffling can be used to generate groves uniformly at random.*

The proof follows from some basic observations about grove shuffling.

**1.4. Frozen regions.** We now describe the phenomenon that we analyze in Section 2. First we observe that edges are indexed relative to the corners perpendicular to them, so in fact the edges  $a$  and  $a'$  in the previous example have the same name:  $a = a' = a_{i,j}$ . Horizontal edges are indexed relative to the bottom corner, and the diagonal edges are indexed relative to the top-right and top-left corners. In this way we can think of grove-shuffling as more akin to domino shuffling [P]. Rather than replacing edges with parallel edges, we “slide” edges toward the corners along perpendicular lines. When a downward-pointing triangle has two edges, we remove both of those edges because they “annihilate” each other. When a downward-pointing triangle has no edges, we create two new ones randomly.

With this viewpoint, we define an edge to be *frozen* if it cannot be annihilated under any further iterations of grove shuffling. Clearly the bottom corner edge,  $a_{0,0}$ , is frozen when present. Then the edge  $a_{i,j}$  is frozen exactly when the edges  $a_{i',j'}$  are frozen,  $i \leq i' \leq 0$ ,  $j \leq j' \leq 0$ . Diagonal edges behave similarly. In Figure 7 all the highlighted edges are frozen.

<sup>3</sup>To see grove shuffling in action, visit <http://ups.physics.wisc.edu/~hal/SSL/groveshuffler/>

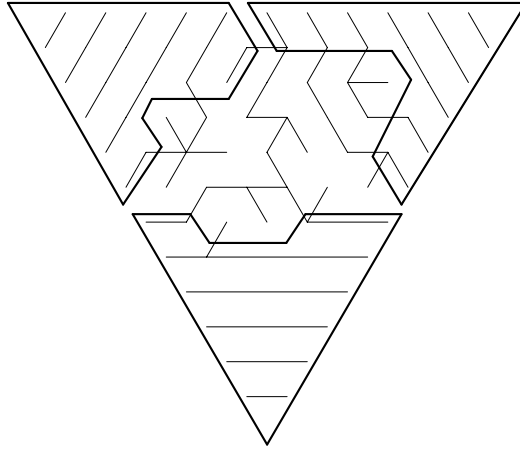

FIGURE 7. Frozen regions of a random grove of order 12

We conclude this section by examining a picture of a large random grove generated by grove shuffling. In Figure 8, we see that outside of a certain region, all of the edges are parallel. Moreover, the boundary between the less uniform interior and the frozen regions in the corners seems to approximate a circle. Proving that this boundary approaches a circle in the limit is the main goal of this paper.

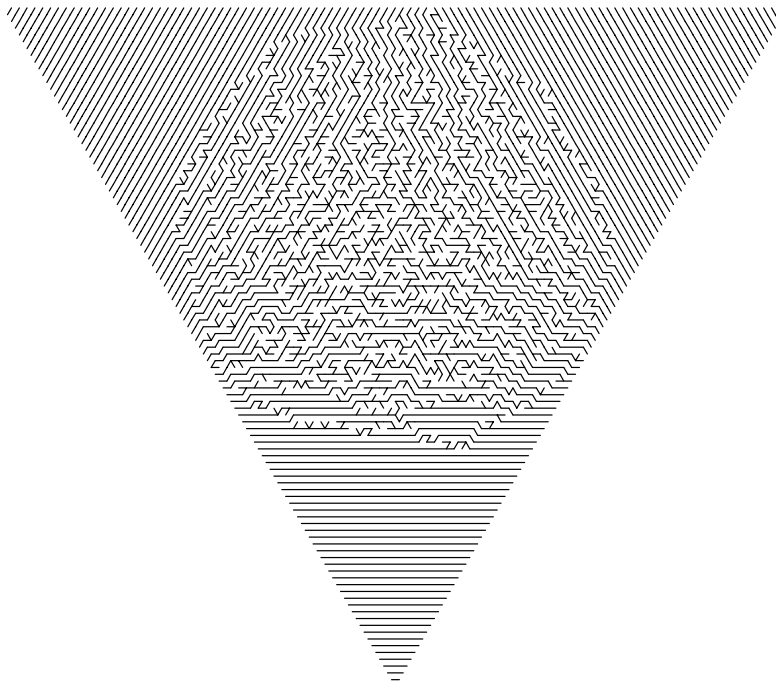

FIGURE 8. A grove on standard initial conditions of order 100

## 2. The arctic circle theorem

For any  $n$ , we can scale the initial conditions so that they resemble an equilateral triangle with sides of length  $\sqrt{2}$ . We will show that outside of the circle inscribed in this triangle, there is homogeneity of the edges in an appropriately scaled random grove of order  $n$ , with probability approaching 1 as  $n \rightarrow \infty$ . Specifically, we will examine the limiting probability of finding a particular type of edge in a given location outside of the inscribed circle.

**2.1. Edge probabilities.** Let  $p_n(i, j) = p(i, j, k)$ ,  $k = -n - i - j - 1$ , be the probability that  $a_n(i, j)$ , the horizontal edge on triangle  $x_{i,j,k+1}$ , is present in a random grove of order  $n$ . Similarly define probabilities  $q_n(k, i), r_n(k, j)$  for the diagonal edges of the same triangle. Define  $E_n(i, j) = E(i, j, k + 1) = 1 - p_n(i, j) - q_n(k, i) - r_n(k, j)$ . The numbers  $E_n(i, j)$  are analogous to the *creation rates* discussed in [JPS], [CEP], and [P]. We will also refer to them as creation rates. Interestingly, we can also realize the number  $E_n(i, j)$  as the expected value of the exponent of the face variable  $x_{i,j,k+1}$ . We prove the following formula for finding the edge probability  $p_n(i, j)$  in terms of creation rates.

**Theorem 2.1.** *The horizontal edge probabilities are given recursively by  $p_n(i, j) = p_{n-1}(i, j) + \frac{2}{3}E_{n-1}(i, j)$ .*

Thus, 
$$p_n(i, j) = \frac{2}{3} \sum_{l=1}^{n-1} E_l(i, j).$$

The proof relies only on observations made directly from grove shuffling. We also point out the similarity between this statement and equation 1.5 of [CEP].

**2.2. A generating function.** We now know that to compute the probability of a particular edge being present in a random grove, it will be enough to compute the creation rates  $E_l(i, j)$ . In this section we derive a generating function for computing these numbers as well as the related generating function for the horizontal edge probabilities.

Let  $F(x, y, z) = \sum_{i,j,k \geq 0} E(-i, -j, -k)x^i y^j z^k$  be the generating function for the creation rates. First consider the uniformly weighted version of the cube recurrence:

$$\begin{aligned} f_{i,j,k} f_{i-1,j-1,k-1} &= \frac{1}{3} (f_{i-1,j,k} f_{i,j-1,k-1} + f_{i,j-1,k} f_{i-1,j,k-1} + f_{i,j,k-1} f_{i-1,j-1,k}). \end{aligned}$$

Using this recurrence to calculate  $f_{0,0,0}$  we will get each monomial weighted uniformly, so that if we set all the initial conditions equal to 1,  $f_{0,0,0} = 1$ . If we want the expectation of the exponent of the face variable  $x = x_{i_0,j_0,k_0}$ , we need only calculate the derivative of  $f_{0,0,0}$  with respect to this variable, then set all variables equal to one. In other words,

$$E(i_0, j_0, k_0) = \frac{\partial}{\partial x} (f_{0,0,0}) \Big|_{x_{i,j,k}=1}$$

Furthermore, we can calculate the intermediate creation rates for  $(i', j', k') \in \mathcal{I}(n')$  with  $n' < n$  by

$$E(i', j', k') = \frac{\partial}{\partial x} (f_{i',j',k'}) \Big|_{x_{i,j,k}=1}$$

(the proof only requires a re-labeling of vertices). With this in mind, let us differentiate the weighted cube recurrence with respect to  $x$ :

$$\begin{aligned} f'_{i,j,k} f_{i-1,j-1,k-1} + f_{i,j,k} f'_{i-1,j-1,k-1} \\ = \frac{1}{3} (f'_{i-1,j,k} f_{i,j-1,k-1} + f_{i-1,j,k} f'_{i,j-1,k-1}) + \\ \frac{1}{3} (f'_{i,j-1,k} f_{i-1,j,k-1} + f_{i,j-1,k} f'_{i-1,j,k-1}) + \\ \frac{1}{3} (f'_{i,j,k-1} f_{i-1,j-1,k} + f_{i,j,k-1} f'_{i-1,j-1,k}). \end{aligned}$$

Now by setting  $x_{i,j,k} = 1$  for all  $(i, j, k)$ , we get a linear recurrence for the expectations in question:

$$\begin{aligned} E(i, j, k) + E(i - 1, j - 1, k - 1) = \frac{1}{3} (E(i - 1, j, k) + E(i, j - 1, k - 1)) + \\ \frac{1}{3} (E(i, j - 1, k) + E(i - 1, j, k - 1)) + \\ \frac{1}{3} (E(i, j, k - 1) + E(i - 1, j - 1, k)). \end{aligned}$$

We can form the rational generating function in the variables  $x, y, z$ :

$$\begin{aligned} F(x, y, z) &= \sum_{i,j,k \geq 0} E(-i, -j, -k) x^i y^j z^k \\ &= \frac{1}{1 + xyz - \frac{1}{3}(x + y + z + xy + xz + yz)}. \end{aligned}$$

Now using the fact that  $p(i, j, k) = p(i, j, k + 1) + (2/3)E(i, j, k)$ , we can derive the formula for the probability generating function:

$$\begin{aligned} G(x, y, z) &= \sum_{i,j,k \geq 0} p(-i, -j, -k) x^i y^j z^k \\ &= \frac{2F(x, y, z)}{3(1 - z)}. \end{aligned}$$

**2.3. Asymptotic analysis.** With our generating function in hand, we can prove our main theorem. First let us embed a triangle in three-space by  $T := \{(x, y, z) \in \mathbf{R}^3 \mid x, y, z \leq 0, x + y + z = -1\}$ . This is the triangle that we will scale  $\mathcal{I}(n)$  to fit. A point  $(x, y, z) \in T$  is outside of the inscribed circle (what will show is the arctic circle) if and only if the angle between the vector  $(x, y, z)$  and vector  $(-1, -1, -1)$  is greater than  $\cos^{-1}(\sqrt{2/3})$ .

Notice that for any point  $(x, y, z)$  outside of the inscribed circle, we have either  $x \leq y + z$ ,  $y \leq x + z$ , or  $z \leq x + y$ , depending on the region in which  $(x, y, z)$  lies. We call the coordinates on the right hand side *small* coordinates.

**Theorem 2.2** (Weak Arctic Circle). *Let  $(x_0, y_0, z_0)$  be a point in  $T$  outside of the inscribed circle for which  $z_0$  is a small coordinate. Let  $(i_n, j_n, k_n)$ ,  $i_n + j_n + k_n = -n - 1$ , be a sequence of nonpositive integer triples such that*

$$\lim_{n \rightarrow \infty} \frac{1}{n + 1} (i_n, j_n, k_n) = (x_0, y_0, z_0).$$

Then  $\lim_{n \rightarrow \infty} p(i_n, j_n, k_n) = 0$ .

In other words, the theorem states that in the upper two regions of  $T$  outside of the arctic circle, the probability of finding a horizontal edge goes to zero as the order of a (scaled) random grove goes to infinity. By symmetry, there can be no diagonal edges in the lower region, and in order to satisfy the connectivity

properties of groves, all the edges in the lower region must be horizontal. The following lemma is the heart of the proof.

**Lemma 2.3.** *Fix a point  $(x_0, y_0, z_0)$  in  $T$  outside of the inscribed circle. Then there are real constants  $A, B, C$  such that*

$$p(-i, -j, -k) = O(e^{-(Ai+Bj+Ck)})$$

for all  $i, j, k \geq 0$  and  $Ax_0 + By_0 + Cz_0 < 0$ .

The proof of the lemma is the most subtle part of the argument. It relies on the Cauchy integral formula and an examination of the singular variety of the generating function. Asymptotics of multivariate generating functions is described in general in the sequence of papers [PW1], [PW2], [PW3], by Robin Pemantle and Mark Wilson. Perhaps their techniques will lead to a stronger version of Theorem 2.2. In particular, we hope for a theorem that describes the statistics throughout the grove, similar to Theorem 1 of [CEP].

### 3. Domino tilings of Aztec diamonds

We now draw parallels between the examination of the behavior of large groves on standard initial conditions, and the behavior of tilings of large Aztec diamonds. This approach yields no new results for Aztec diamonds, but presents an alternative approach to their study. In this section we derive a generating function for the probabilities  $p_n(i, j)$  that position  $(i, j)$  in a tiling of an Aztec diamond of order  $n$  is covered by a particular type of horizontal domino. The asymptotics for the function we will derive are discussed as an example in [PW1]. The first derivation of the function is due to Jim Propp and Dan Ionescu, though their (different) derivation has never been published. Some recursive formulas for  $p_n(i, j)$  are given in [P], and are the inspiration for our derivation of the edge probabilities for groves. We list the analogous results.

**Theorem 3.1** ([P]). *The horizontal edge probabilities are given recursively by  $p_n(i, j) = p_{n-1}(i, j) + \frac{1}{2}E_{n-1}(i, j)$ . Thus,  $p_n(i, j) = \frac{1}{2} \sum_{l=1}^{n-1} E_l(i, j)$ .*

The theorem follows more or less directly from the definition of domino shuffling, where  $E_n(i, j)$  is the net creation rate (see [EKLP], [P]).

By differentiating the uniformly weighted version of the octahedron recurrence

$$g_{i,j,n+1}g_{i,j,n-1} = \frac{1}{2}(g_{i-1,j,n}g_{i+1,j,n} + g_{i,j-1,n}g_{i,j+1,n}),$$

and because

$$E_n(i_0, j_0) = \frac{\partial}{\partial x} (g_{0,0,n}) \Big|_{x_{i,j}=1}$$

we obtain

$$E_{n+1}(i, j) + E_{n-1}(i, j) = \frac{1}{2}(E_n(i-1, j) + E_n(i+1, j)) + \frac{1}{2}(E_n(i, j-1) + E_n(i, j+1)).$$

From this recurrence and Theorem 4 we get the generating function:

$$\begin{aligned} G(x, y, z) &= \sum_{n \geq 0} \sum_{|i|+|j| \leq n} p_n(i, j) x^i y^j z^n \\ &= \frac{z/2}{(1-yz)(1+z^2 - \frac{z}{2}(x+x^{-1} + y+y^{-1}))}. \end{aligned}$$

This is the form of the generating function used as an example in [PW1]. A weak arctic circle theorem like ours for groves follows directly from that example. Probabilities throughout the diamond could be extracted from this function in principle, though the analysis is more difficult.

#### 4. Further speculation on statistics of groves

As mentioned, we hope to apply the methods of Pemantle and Wilson to determine asymptotic probabilities throughout a random grove. Based on computer experiments and the similarity of groves and Aztec diamond tilings seen so far, we believe a formula for such probabilities exists.

Another future aim is to apply the methods of growth models and statistical mechanics to groves, in the style of Johansson [J1], [J2]. One clever way for determining the boundary of the frozen region for Aztec diamond tilings is to look at a frozen corner as a randomly growing Young diagram. See [JPS] for the first description of this interpretation. A nearly identical projection of the frozen region of a grove yields some sort of randomly growing Young diagram, but it seems to follow more intricate rules of growth than those of Aztec diamond tilings.

In [CEP], the authors considered non-uniform distributions on the set of all tilings of the Aztec diamond. In the shuffling algorithm, rather than having horizontal or vertical tiles chosen with equal probability, the choice is biased towards one type of tile or the other. In this situation, there still appear frozen regions and a temperate zone, but the boundary is no longer a circle, but an ellipse. By analogy, we have also considered biased groves. Rather than making the random choice in grove shuffling be uniform, we make one choice with probability  $\alpha$ , another with probability  $\beta$  and the third with probability  $\gamma = 1 - \alpha - \beta$ . This bias emerges in the generating function for creation rates as:

$$F(x, y, z) = \frac{1}{1 + xyz - \alpha(x + yz) - \beta(y + xz) - \gamma(z + xy)}.$$

The boundary from temperate zone to frozen regions generalizes from a circle to an ellipse just as in the Aztec diamond case, here given by the intersection of the plane  $x + y + z = -1$  with the surface

$$rs + rt + st = \frac{r^2 + s^2 + t^2}{2},$$

where  $r = (1 - \alpha)x$ ,  $s = (1 - \beta)y$ , and  $t = (\alpha + \beta)z$ .

#### References

- [CS] G. Carroll and D. Speyer, *The cube recurrence*, preprint.
- [CEP] H. Cohn, N. Elkies, and J. Propp, *Local statistics for random domino tilings of the Aztec diamond*, *Duke Math Journal* **85**(1) (1996), 117–166.
- [EKLP] N. Elkies, G. Kuperberg, M. Larsen, and J. Propp, *Alternating sign matrices and domino tilings*, *Journal of Algebraic Combinatorics* **1** (1992), 111–132 and 219–234.
- [FZ] S. Fomin and A. Zelevinsky, *The Laurent phenomenon*, *Advances in Applied Mathematics* **28** (2002), 119–144.
- [JPS] W. Jockusch, J. Propp, P. Shor, *Random domino tilings and the arctic circle theorem*, in preparation.
- [J1] K. Johansson, *Non-intersecting paths, random tilings and random matrices*, *Probability Theory and Related Fields* **123** (2002), 225–280.
- [J2] K. Johansson, *Shape fluctuations and random matrices*, *Communications in Mathematical Physics*, **209** (2000), 437–476.
- [PW1] R. Pemantle and M. Wilson, *Asymptotics of multivariate sequences I. Smooth points of the singular variety*, *Journal of Combinatorial Theory Series A*, **97** (2002), 129–161.
- [PW2] R. Pemantle and M. Wilson, *Asymptotics of multivariate sequences II*, preprint.
- [PW3] R. Pemantle and M. Wilson, *Asymptotics of multivariate sequences III*, in preparation.
- [P] J. Propp, *Generalized domino shuffling*, *Theoretical Computer Science* **303** (2003), 267–301.

DEPARTMENT OF MATHEMATICS, BRANDEIS UNIVERSITY, WALTHAM, MA, USA, 02454

*E-mail address:* tkpeters@brandeis.edu

*URL:* <http://people.brandeis.edu/~tkpeters>

DEPARTMENT OF MATHEMATICS, UNIVERSITY OF CALIFORNIA BERKELEY, BERKELEY, CA, USA 94720

*E-mail address:* speyer@math.berkeley.edu



# The Equivariant Orlik-Solomon Algebra

Nicholas Proudfoot

**Abstract.** *Given a real hyperplane arrangement  $\mathcal{A}$ , the complement  $\mathcal{M}(\mathcal{A})$  of the complexification of  $\mathcal{A}$  admits an action of  $\mathbb{Z}_2$  by complex conjugation. We define the equivariant Orlik-Solomon algebra of  $\mathcal{A}$  to be the  $\mathbb{Z}_2$ -equivariant cohomology ring of  $\mathcal{M}(\mathcal{A})$  with coefficients in  $\mathbb{Z}_2$ . We give a combinatorial presentation of this ring, and interpret it as a deformation of the ordinary Orlik-Solomon algebra into the Varchenko-Gel'fand ring of locally constant  $\mathbb{Z}_2$ -valued functions on the complement  $\mathcal{M}_{\mathbb{R}}(\mathcal{A})$  of  $\mathcal{A}$  in  $\mathbb{R}^n$ . We also show that the  $\mathbb{Z}_2$ -equivariant homotopy type of  $\mathcal{M}(\mathcal{A})$  is determined by the oriented matroid of  $\mathcal{A}$ . As an application, we give two examples of pairs of arrangements  $\mathcal{A}$  and  $\mathcal{A}'$  such that  $\mathcal{M}(\mathcal{A})$  and  $\mathcal{M}(\mathcal{A}')$  have the same nonequivariant homotopy type, but are distinguished by the equivariant Orlik-Solomon algebra.*

## 1. Introduction

Let  $\mathcal{A} = \{H_1, \dots, H_n\}$  be an arrangement of  $n$  hyperplanes in  $\mathbb{C}^d$ , with  $H_i = \omega_i^{-1}(0)$  for some affine linear map  $\omega_i : \mathbb{C}^d \rightarrow \mathbb{C}$ . Let  $\mathcal{M}(\mathcal{A})$  denote the complement of  $\mathcal{A}$  in  $\mathbb{C}^d$ . It is a fundamental problem in the study of hyperplane arrangements to study the extent to which the topology of  $\mathcal{M}(\mathcal{A})$  is determined by the combinatorics of  $\mathcal{A}$ .

Let  $\mathcal{CA}$  denote the central arrangement of hyperplanes in  $\mathbb{C}^{d+1}$  given by first adding a “hyperplane at infinity” to  $\mathcal{A}$  to produce an arrangement of hyperplanes in  $\mathbb{C}P^d$ , and then taking its cone. The *pointed matroid* of  $\mathcal{A}$  is defined to be the matroid of dependence relations among the hyperplanes of  $\mathcal{CA}$ , along with a specified basepoint corresponding to the cone over the hyperplane at infinity [F2]. Geometrically, the pointed matroid encodes two types of data:

- (1) which subsets  $S \subseteq \{1, \dots, n\}$  have the property that  $\bigcap_{i \in S} H_i = \emptyset$ , and
- (2) which subsets  $S \subseteq \{1, \dots, n\}$  have the property that  $\text{codim} \bigcap_{i \in S} H_i > |S|$ .

**Definition 1.1.** The *Orlik-Solomon algebra*  $A(\mathcal{A}; R)$  is the cohomology ring  $H^*(\mathcal{M}(\mathcal{A}); R)$  of the complement of the complexified arrangement with coefficients in the ring  $R$ .

For each  $i \leq n$ , let  $e_i = \omega_i^*[\mathbb{R}^+] \in A(\mathcal{A}; R)$  be the pullback of the generator  $[\mathbb{R}^+] \in H^1(\mathbb{C}^*; R)$  under the map  $\omega_i : \mathcal{M}(\mathcal{A}) \rightarrow \mathbb{C} \setminus \{0\}$ . The following theorem, due to Orlik and Solomon, states that the elements  $e_1, \dots, e_n$  generate  $A(\mathcal{A}; R)$ , and gives explicit relations in terms of the pointed matroid of  $\mathcal{A}$ . We give here a simplified version by working only with the coefficient ring  $R = \mathbb{Z}_2$ , because this is the version that will extend well to the equivariant setting.

---

1991 *Mathematics Subject Classification.* 52C35.

*Key words and phrases.* hyperplane arrangements, equivariant cohomology.

**Theorem 1.2.** [OT] Consider the linear map  $\partial = \sum_{i=1}^n \frac{\partial}{\partial e_i}$  from  $\mathbb{Z}_2[e_1, \dots, e_n]$  to itself, lowering degree by 1. The Orlik-Solomon algebra  $A(\mathcal{A}; \mathbb{Z}_2)$  is isomorphic to  $\mathbb{Z}_2[e_1, \dots, e_n]/\mathcal{I}$ , where  $\mathcal{I}$  is generated by the following three families of relations:

- 1)  $e_i^2$  for  $i \in \{1, \dots, n\}$
- 2)  $\prod_{i \in S} e_i$  if  $\bigcap_{i \in S} H_i = \emptyset$
- 3)  $\partial \prod_{i \in S} e_i$  if  $\bigcap_{i \in S} H_i$  is nonempty with codimension greater than  $|S|$ .

Now suppose that our arrangement  $\mathcal{A}$  is defined over the real numbers. More precisely, suppose that  $\omega_i$  restricts to a map  $\omega_i : \mathbb{R}^d \rightarrow \mathbb{R}$  for all  $i$ . Let

$$H_i^+ = \{p \mid \omega_i(p) \geq 0\} \quad \text{and} \quad H_i^- = \{p \mid \omega_i(p) \leq 0\},$$

both half-spaces in  $\mathbb{R}^d$  with boundary  $H_i$ . The *pointed oriented matroid* of  $\mathcal{A}$  is defined to be the oriented matroid with basepoint given by the dependence relations of  $\mathcal{CA}$ . Like the pointed matroid, the pointed oriented matroid also encodes two types of geometrical data:

- (1) which pairs  $S^+, S^- \subseteq \{1, \dots, n\}$  have the property that  $\bigcap_{i \in S^+} H_i^+ \cap \bigcap_{j \in S^-} H_j^- = \emptyset$ , and
- (2) which pairs  $S^+, S^- \subseteq \{1, \dots, n\}$  have the property that  $\bigcap_{i \in S^+} H_i^+ \cap \bigcap_{j \in S^-} H_j^-$  is nonempty and contained in some hyperplane.

In this paper we study the action of  $\mathbb{Z}_2 = \text{Gal}(\mathbb{C}/\mathbb{R})$  on  $\mathcal{M}(\mathcal{A})$  by complex conjugation, with fixed point set  $\mathcal{M}_{\mathbb{R}}(\mathcal{A}) \subseteq \mathbb{R}^d$  equal to the complement of the real loci of the hyperplanes. This is an enhancement of the topological data of  $\mathcal{A}$ , just as the pointed oriented matroid is an enhancement of the combinatorial data. It is therefore natural to make the following definition.

**Definition 1.3.** The *equivariant Orlik-Solomon algebra*  $\mathcal{A}_2(\mathcal{A}, \mathbb{Z}_2)$  of a hyperplane arrangement defined over  $\mathbb{R}$  is the equivariant cohomology ring  $H_{\mathbb{Z}_2}^*(\mathcal{M}(\mathcal{A}); \mathbb{Z}_2)$ .

In Section 3 we give a presentation of the equivariant Orlik-Solomon algebra in terms of the pointed oriented matroid of  $\mathcal{A}$ , analogous to Theorem 1.2.<sup>1</sup> Moreover, we interpret  $\mathcal{A}_2(\mathcal{A}, \mathbb{Z}_2)$  as a deformation from the ordinary Orlik-Solomon algebra  $A(\mathcal{A}; \mathbb{Z})$  to the *Varchenko-Gel'fand ring*  $VG(\mathcal{A}; \mathbb{Z}_2)$ , which is defined to be the ring of locally constant functions from  $\mathcal{M}_{\mathbb{R}}(\mathcal{A})$  to  $\mathbb{Z}_2$ . We thus recover by independent means the presentation of  $VG(\mathcal{A}; \mathbb{Z}_2)$  given in [VG], and provide a topological explanation for the parallels that Varchenko and Gel'fand observe between the the rings  $A(\mathcal{A}; \mathbb{Z})$  and  $VG(\mathcal{A}; \mathbb{Z}_2)$ . Note that, while the Orlik-Solomon algebra is super-commutative and the Varchenko-Gel'fand ring is commutative, these two notions agree in characteristic 2.

A celebrated theorem of Salvetti [Sa] says that if  $\mathcal{A}$  is central and essential, then  $\mathcal{M}(\mathcal{A})$  is homotopy equivalent to a simplicial complex that can be constructed from the oriented matroid<sup>2</sup> of  $\mathcal{A}$  (see [Sa], [Pa], and [GR]). In Section 4, we show that this simplicial complex has a natural, combinatorially defined action of  $\mathbb{Z}_2$ , and that the homotopy equivalence is equivariant with respect to this action. Hence the oriented matroid of  $\mathcal{A}$  in fact determines the equivariant homotopy type of  $\mathcal{M}(\mathcal{A})$ . This observation provides an explanation for the recent discovery of Huisman that the equivariant fundamental group of a line arrangement is determined by its pointed oriented matroid [Hu].

We conclude by discussing three examples which illustrate the similarities and differences between the equivariant and nonequivariant pictures. In Example 5.2 we consider the famous first example of two real arrangements with different pointed matroids, but with homotopy equivalent complements [F1]. We show

<sup>1</sup>A special case of this presentation first appeared in [HP, 5.5], using the geometry of hypertoric varieties.

<sup>2</sup>If  $\mathcal{A}$  is central, the oriented matroid and pointed oriented matroid encode the same data.



that these two arrangements are distinguished by the equivariant Orlik-Solomon algebra, hence the homotopy equivalence cannot be made equivariant. In Example 5.4, we consider two arrangements whose pointed oriented matroids are related by a flip [F1]. This implies that their complements are homotopy equivalent, and that their unoriented pointed matroids are isomorphic, but once again their equivariant homotopy types are distinguished by the equivariant Orlik-Solomon algebra. We conclude with a problem and a conjecture regarding the relationship between the combinatorial data and the equivariant topology of a real arrangement.

*Acknowledgments.* The author is grateful to Graham Denham for pointing out the similarity between the rings described in [HP] and [VG], and to Michael Falk for his help in understanding many examples.

## 2. Equivariant cohomology

In this section we review some basic definitions and results from [Bo]. Let  $X$  be a topological space equipped with an action of a group  $G$ .

**Definition 2.1.** Let  $EG$  be a contractible space with a free  $G$ -action. Then we put

$$X_G := X \times_G EG = (X \times EG)/G$$

(well-defined up to homotopy equivalence), and define the  $G$ -equivariant cohomology of  $X$

$$H_G^*(X) := H^*(X_G).$$

The  $G$ -equivariant map from  $X$  to a point induces a map on cohomology in the other direction, hence  $H_G^*(X)$  is a module over  $H_G^*(pt) \cong H^*(BG)$ , where  $BG = EG/G$  is the classifying space for  $G$ . Indeed,  $H_G^*$  is a contravariant functor from the category of  $G$ -spaces to the category of  $H_G^*(pt)$ -modules.

**Example 2.2.** If  $G = \mathbb{Z}_2$ , then we may take  $EG = S^\infty$  and  $BG = S^\infty/\mathbb{Z}_2 = \mathbb{R}P^\infty$ . Then  $H_{\mathbb{Z}_2}^*(pt; \mathbb{Z}_2) = H^*(\mathbb{R}P^\infty; \mathbb{Z}_2) \cong \mathbb{Z}_2[x]$ .

Suppose that  $X$  is a finite-dimensional manifold, and let  $Y \subseteq X$  be a  $G$ -invariant submanifold. We denote by  $[Y] \in H_G^*(X)$  the cohomology class represented in Borel-Moore homology by the finite-codimension submanifold  $Y_G \subseteq X_G$ . This will be our principal means of understanding specific equivariant cohomology classes in this paper. We will need two technical theorems about equivariant cohomology, both of which we state below. Let  $X$  be a  $\mathbb{Z}_2$ -space, and let  $F \subseteq X$  be the fixed point set.

**Theorem 2.3.** [Bo, §XII, 3.5] *Suppose that  $F$  is nonempty, the induced action of  $\mathbb{Z}_2$  on  $H^*(X; \mathbb{Z}_2)$  is trivial, and  $H^*(X; \mathbb{Z}_2)$  is generated in degree 1. Then the Leray-Serre spectral sequence for the fiber bundle  $X \hookrightarrow X_{\mathbb{Z}_2} \xrightarrow{\tilde{\Omega}} \mathbb{R}P^\infty$  collapses at the  $E_2$  term.*

**Corollary 2.4.** *Under the hypotheses of Theorem 2.3, any additive basis from  $H^*(X; \mathbb{Z}_2)$  lifts to a  $\mathbb{Z}_2[x]$ -basis for  $H_{\mathbb{Z}_2}^*(X; \mathbb{Z}_2)$  (and any set of lifts will do). In particular,  $H_{\mathbb{Z}_2}^*(X; \mathbb{Z}_2)$  is a free module over  $\mathbb{Z}_2[x]$ .*

**Theorem 2.5.** [Bo, §IV, 3.7(b)] *The restriction map*

$$H_{\mathbb{Z}_2}^*(X; \mathbb{Z}_2) \xrightarrow{\tilde{\Omega}} H_{\mathbb{Z}_2}^*(F; \mathbb{Z}_2) \cong H^*(F; \mathbb{Z}_2)[x]$$

*is an isomorphism in all degrees greater than the dimension of  $X$ .*

Corollary 2.4 says that we may interpret  $H_{\mathbb{Z}_2}^*(X; \mathbb{Z}_2)$  as a flat family of rings over the  $\mathbb{Z}_2$  affine line. The following corollary says that this family is a deformation of  $H^*(X; \mathbb{Z}_2)$  into  $H^*(F; \mathbb{Z}_2)$ .

**Corollary 2.6.** *Under the hypotheses of Theorem 2.3,*

$$H^*(X; \mathbb{Z}_2) \cong H_{\mathbb{Z}_2}^*(X; \mathbb{Z}_2)/\langle x \rangle$$

and

$$H^*(F; \mathbb{Z}_2) \cong H_{\mathbb{Z}_2}^*(X; \mathbb{Z}_2)/\langle x - 1 \rangle.$$

PROOF. The first statement follows immediately from Corollary 2.4. For the second statement, consider the ring  $H_{\mathbb{Z}_2}^*(X; \mathbb{Z}_2)[x^{-1}]$  obtained by formally inverting  $x$ . Theorem 2.5 tells us that the restriction map

$$H_{\mathbb{Z}_2}^*(X; \mathbb{Z}_2)[x^{-1}] \tilde{\Omega} H_{\mathbb{Z}_2}^*(F; \mathbb{Z}_2)[x^{-1}] \cong H^*(F; \mathbb{Z}_2)[x, x^{-1}]$$

is an isomorphism in high degree. But this map commutes with multiplication by  $x$  and  $x^{-1}$ , so it must be an isomorphism in every degree. Setting  $x$  equal to 1, we obtain the desired result.  $\square$

The following example will be fundamental to our applications.

**Example 2.7.** Let  $X = \mathbb{C}^*$ , with  $\mathbb{Z}_2$  acting by complex conjugation. Since  $X$  deformation-retracts equivariantly onto the compact space  $S^1$ , Theorem 2.3 applies. The image of  $x$  under the standard map  $\mathbb{Z}_2[x] = H_{\mathbb{Z}_2}^*(pt, \mathbb{Z}_2) \tilde{\Omega} H_{\mathbb{Z}_2}^*(X; \mathbb{Z}_2)$  is the  $\mathbb{Z}_2$ -equivariant Euler class of the topologically trivial real line bundle with a nontrivial  $\mathbb{Z}_2$  action. This bundle has a  $\mathbb{Z}_2$ -equivariant section, transverse to the zero section, vanishing exactly on the real points of  $X$ , and is therefore represented by the submanifold  $\mathbb{R}^* \subseteq \mathbb{C}^*$ . Abusing notation, we will write  $x = [\mathbb{R}^*] \in H_{\mathbb{Z}_2}^*(X; \mathbb{Z}_2)$ . Let  $y = [\mathbb{R}^+] \in H_{\mathbb{Z}_2}^*(X; \mathbb{Z}_2)$ . Then  $x - y$  is represented by  $\mathbb{R}^-$ , therefore  $y(x - y) = 0$ . Corollary 2.4 says that  $H_{\mathbb{Z}_2}^*(X; \mathbb{Z}_2)$  is additively generated by  $x$  and  $y$ . Since  $\mathbb{Z}_2[x, y]/\langle y(x - y) \rangle$  is already a free module of rank 2 over  $\mathbb{Z}_2[x]$ , Corollary 2.4 tells us that there can be no more relations.

### 3. The equivariant Orlik-Solomon algebra

We now give a combinatorial presentation of the equivariant Orlik-Solomon algebra.

**Theorem 3.1.** *The ring  $A_2(\mathcal{A}; \mathbb{Z}_2)$  is isomorphic to  $\mathbb{Z}_2[e_1, \dots, e_n, x]/\mathcal{J}$ , where  $\mathcal{J}$  is generated by the following three families of relations:<sup>3</sup>*

- 1)  $e_i(x - e_i)$  for  $i \in \{1, \dots, n\}$
- 2)  $\prod_{i \in S^+} e_i \times \prod_{j \in S^-} (x - e_j)$  if  $\bigcap_{i \in S^+} H_i^+ \cap \bigcap_{j \in S^-} H_j^- = \emptyset$
- 3)  $x^{-1} \left( \prod_{i \in S^+} e_i \times \prod_{j \in S^-} (x - e_j) - \prod_{i \in S^+} (x - e_i) \times \prod_{j \in S^-} e_j \right)$   
 if  $\bigcap_{i \in S^+} H_i^+ \cap \bigcap_{j \in S^-} H_j^-$  is nonempty and contained  
 in some hyperplane  $H_k$ .

PROOF. Let  $y = [\mathbb{R}^+] \in H_{\mathbb{Z}_2}^*(\mathbb{C}^*; \mathbb{Z}_2)$ , and let

$$e_i = \omega_i^*(y) \in A_2(\mathcal{A}; \mathbb{Z}_2),$$

represented by the submanifold

$$Y_i^+ = \omega_i^{-1}(\mathbb{R}^+).$$

Let  $x \in A_2(\mathcal{A}; \mathbb{Z}_2)$  be the image of the generator of  $H_{\mathbb{Z}_2}^*(pt; \mathbb{Z}_2)$ ; by functoriality, we have  $x = \omega_i^*(x)$  for all  $i$ . Recall from Example 2.7 that  $[\mathbb{R}^-] = x - y \in H_{\mathbb{Z}_2}^*(\mathbb{C}^*; \mathbb{Z}_2)$ , hence

$$x - e_i = \omega^*(x - y) \in A_2(\mathcal{A}; \mathbb{Z}_2)$$

---

<sup>3</sup>Note that all of these relations are polynomial; the  $x^{-1}$  in the third relation cancels.

is represented by the submanifold

$$Y_i^- = \omega^{-1}(\mathbb{R}^-).$$

Theorem 1.2 tells us that  $e_1, \dots, e_n$  are lifts of ring generators for the ordinary Orlik-Solomon algebra  $A(\mathcal{A}; \mathbb{Z}_2)$ . Since the manifolds  $Y_i^+$  are stable under the action of  $\mathbb{Z}_2$ , the induced action of  $\mathbb{Z}_2$  on  $A(\mathcal{A}; \mathbb{Z}_2)$  is trivial. The space  $\mathcal{M}(\mathcal{A})$  has a compact  $\mathbb{Z}_2$ -equivariant deformation retract, therefore Corollary 2.3 tells us that  $A_2(\mathcal{A}; \mathbb{Z}_2)$  is generated as a ring by the classes  $e_i$  and  $x$ . We must now check that each of the three families of generators of  $\mathcal{J}$  do indeed vanish in  $A_2(\mathcal{A}; \mathbb{Z}_2)$ , and that they generate all of the relations.

The first family of relations follows from the fact that  $Y_i^+ \cap Y_i^- = \emptyset$  for all  $i \in \{1, \dots, n\}$ . For the second family, we must show that if

$$\bigcap_{i \in S^+} H_i^+ \cap \bigcap_{j \in S^-} H_j^- = \emptyset,$$

then

$$\bigcap_{i \in S^+} Y_i^+ \cap \bigcap_{j \in S^-} Y_j^- = \emptyset.$$

Suppose that

$$p \in \bigcap_{i \in S^+} Y_i^+ \cap \bigcap_{j \in S^-} Y_j^-,$$

in other words  $\omega_i(p) \in \mathbb{R}^+$  for all  $i \in S^+$  and  $\omega_j(p) \in \mathbb{R}^-$  for all  $j \in S^-$ . Then the real part

$$\text{Re}(p) \in \bigcap_{i \in S^+} H_i^+ \cap \bigcap_{j \in S^-} H_j^-,$$

hence the intersection is not empty.

The argument for the third family is similar. First, note that since  $A_2(\mathcal{A}; \mathbb{Z}_2)$  is free over  $\mathbb{Z}_2[x]$ , it is sufficient to show that

$$\prod_{i \in S^+} e_i \times \prod_{j \in S^-} (x - e_j) - \prod_{i \in S^+} (x - e_i) \times \prod_{j \in S^-} e_j = 0.$$

We treat each of the two terms separately. Suppose that

$$p \in \bigcap_{i \in S^+} Y_i^+ \cap \bigcap_{j \in S^-} Y_j^-.$$

Then, as above, we have

$$\text{Re}(p) \in \bigcap_{i \in S^+} H_i^+ \cap \bigcap_{j \in S^-} H_j^-.$$

Furthermore, there exists  $\delta > 0$  such that for any  $q \in \mathbb{R}^n$  of norm less than  $\delta$ ,

$$p + q \in \bigcap_{i \in S^+} Y_i^+ \cap \bigcap_{j \in S^-} Y_j^-,$$

and hence

$$\text{Re}(p) + q \in \bigcap_{i \in S^+} H_i^+ \cap \bigcap_{j \in S^-} H_j^-.$$

Since  $\{\text{Re}(p + q) \mid |q| < \delta\}$  is an open subset of  $\mathbb{R}^n$ , the intersection  $\bigcap_{i \in S^+} H_i^+ \cap \bigcap_{j \in S^-} H_j^-$  cannot be contained in a hyperplane. Hence we have

$$\prod_{i \in S^+} e_i \times \prod_{j \in S^-} (x - e_j) = \prod_{i \in S^+} (x - e_i) \times \prod_{j \in S^-} e_j = 0.$$

Now we must show that we have found all of the relations. Let

$$\psi : \mathbb{Z}_2[e_1, \dots, e_n, x] \tilde{\Omega} \mathbb{Z}_2[e_1, \dots, e_n]$$

be the map given by sending  $x$  to zero, and note that  $\psi(\mathcal{J}) = \mathcal{I}$ . Now suppose that  $\alpha \in \mathbb{Z}_2[e_1, \dots, e_n, x]$  is a relation in  $A_2(\mathcal{A}; \mathbb{Z}_2)$  that is *not* in the ideal  $\mathcal{J}$ , and choose  $\alpha$  of minimal degree. By Corollary 2.6 we must have  $\psi(\alpha) \in \mathcal{I}$ , hence there exists  $\beta \in \mathcal{J}$  with  $\psi(\alpha - \beta) = 0$ . This implies that  $\alpha - \beta = x\gamma$  for some  $\gamma \in \mathbb{Z}_2[e_1, \dots, e_n, x]$ . Since  $\alpha$  and  $\beta$  are both relations in  $A_2(\mathcal{A}; \mathbb{Z}_2)$ , and  $A_2(\mathcal{A}; \mathbb{Z}_2)$  is free over  $\mathbb{Z}_2[x]$ ,  $\gamma$  must also be a relation. Since  $\beta$  is in  $\mathcal{J}$  and  $\alpha$  is not,  $\gamma$  cannot be in  $\mathcal{J}$ . Since  $\deg \gamma = \deg \alpha - 1$ , we have reached a contradiction.  $\square$

By Corollary 2.6,  $A_2(\mathcal{A}; \mathbb{Z}_2)$  is a flat family of rings parametrized by the affine line  $\text{Spec } \mathbb{Z}_2[x]$ , specializing at  $x = 0$  to  $H^*(\mathcal{M}(\mathcal{A}); \mathbb{Z}_2) = A(\mathcal{A}; \mathbb{Z}_2)$ , and at  $x = 1$  to  $H^*(\mathcal{M}_{\mathbb{R}}(\mathcal{A}); \mathbb{Z}_2) = VG(\mathcal{A}; \mathbb{Z}_2)$ . In particular, this provides a topological explanation for the fact that the dimension of the Orlik-Solomon algebra is equal to the number of connected components of  $\mathcal{M}_{\mathbb{R}}(\mathcal{A})$ . By setting  $x = 1$  in Theorem 3.1 we obtain a nontrivial presentation of  $VG(\mathcal{A}; \mathbb{Z}_2)$ , first given in the central case (over the integers) in [VG]. Varchenko and Gel'fand interpret  $e_i \in VG(\mathcal{A}; \mathbb{Z}_2)$  as the  $i^{\text{th}}$  Heaviside function  $\mathcal{M}_{\mathbb{R}}(\mathcal{A}) \tilde{\Omega} \mathbb{R}$ , restricting to 1 on  $\mathcal{M}_{\mathbb{R}}(\mathcal{A}) \cap H_i^+$  and 0 on  $\mathcal{M}_{\mathbb{R}}(\mathcal{A}) \cap H_i^-$ . These functions are easily seen to generate the ring  $VG(\mathcal{A}; \mathbb{Z}_2)$ , and the three families of relations are clear, but the proof that there are no other relations is nontrivial. Varchenko and Gel'fand observe that this presentation defines a filtration on  $VG(\mathcal{A}; \mathbb{Z}_2)$  with  $A(\mathcal{A}; \mathbb{Z}_2)$  as its associate graded. This is also a consequence of Corollaries 2.4 and 2.6; this phenomenon is explored in greater detail in [Ca].

**Remark 3.2.** Our presentations of  $VG(\mathcal{A}; \mathbb{Z}_2)$  and  $A_2(\mathcal{A}; \mathbb{Z}_2)$  depend on the coorientations of the hyperplanes, while the isomorphism classes of the rings themselves do not. Reversing the orientation of the hyperplane  $H_i$  corresponds to changing every appearance of  $e_i$  to  $x - e_i$  in the generators of  $\mathcal{J}$ .

#### 4. The Salvetti complex

Let  $\mathcal{A}$  be an essential central arrangement in  $\mathbb{R}^d$ . Salvetti [Sa] has constructed a simplicial complex from a poset  $\text{Sal}(\mathcal{A})$ , depending only on the oriented matroid of  $\mathcal{A}$ , which is homotopy equivalent to the complement  $\mathcal{M}(\mathcal{A})$  of the complexification of  $\mathcal{A}$ . In this section we define a combinatorial action of  $\mathbb{Z}_2$  on  $\text{Sal}(\mathcal{A})$ , and show that the homotopy equivalence is equivariant.

The hyperplanes of  $\mathcal{A}$  subdivide  $\mathbb{R}^d$  into faces, open in their supports, which form a poset  $\mathcal{F}$  ordered by reverse inclusion. The minimal elements of  $\mathcal{F}$  are the connected components of  $\mathcal{M}_{\mathbb{R}}(\mathcal{A})$ , and  $\{0\}$  is the unique maximal element. The *Salvetti poset*  $\text{Sal}(\mathcal{A})$  is a poset consisting of elements of the form

$$\{(F, C) \mid C \text{ minimal and } C \leq F\}.$$

The partial order is determined by putting  $(F', C') \leq (F, C)$  if and only if  $F' \leq F$  and  $C' = F'C$ , where the latter equality means that  $C$  and  $C'$  lie on the same side of every hyperplane containing  $F'$ . The *Salvetti complex*  $|\text{Sal}(\mathcal{A})|$  is defined to be the order complex of this poset.

The poset  $\text{Sal}(\mathcal{A})$  admits an action of  $\mathbb{Z}_2$  given by setting  $(F, C)^* = (F, \tilde{C})$ , where  $\tilde{C}$  is obtained from  $C$  by reflecting it over all of the hyperplanes that contain  $F$ . In [GR],  $\text{Sal}(\mathcal{A})$  is defined as a subset of the set of all functions from the ground set of the oriented matroid to the set  $\{\pm 1, \pm i\}$ . In this language, our  $\mathbb{Z}_2$ -action is simply complex conjugation, and is easily seen to be an invariant of the oriented matroid. This action induces an action of  $\mathbb{Z}_2$  on the Salvetti complex  $|\text{Sal}(\mathcal{A})|$ .

**Theorem 4.1.** *The complex  $|\text{Sal}(\mathcal{A})|$  is equivariantly homotopy equivalent to  $\mathcal{M}(\mathcal{A})$ . In particular, the equivariant homotopy type of  $\mathcal{M}(\mathcal{A})$  is determined by the oriented matroid associated to  $\mathcal{A}$ .*

PROOF. For every  $F \in \mathcal{F}$ , choose a point  $x(F) \in F \subseteq \mathbb{R}^d$ . Each element of  $\text{Sal}(\mathcal{A})$  determines a vertex in the complex  $|\text{Sal}(\mathcal{A})|$ . For all  $(F, C) \in \text{Sal}(\mathcal{A})$ , let

$$V(F, C) = \begin{cases} \left\{ \sum_{C' \leq F} \lambda_{C'} x(C') \mid \lambda_{C'} > 0 \right\} & \text{if } F \neq \{0\} \\ \mathbb{R}^d & \text{if } F = \{0\}, \end{cases}$$

and let

$$W(F, C) = \{x \in \mathbb{R}^d \mid x \text{ and } C \text{ lie on the same side of every hyperplane containing } F\}.$$

Paris [Pa] shows that

$$\mathcal{U} = \left\{ V(F, C) + iW(F, C) \mid (F, C) \in \text{Sal}(\mathcal{A}) \right\}$$

is an open cover of  $\mathcal{M}(\mathcal{A})$  with nerve  $|\text{Sal}(\mathcal{A})|$ , and that any nonempty intersection of open sets from  $\mathcal{U}$  is contractible, hence concluding that  $\mathcal{M}(\mathcal{A})$  is homotopy equivalent to  $|\text{Sal}(\mathcal{A})|$ . To extend this proof to the equivariant context, we need only observe that  $W(F, \tilde{C}) = W(F, C)$ , and  $V(F, \tilde{C}) = -V(F, C)$ . Both of these equalities are clear from the definitions.  $\square$

**Remark 4.2.** The Salvetti complex may be defined for an arbitrary oriented matroid, which may not be realizable by a hyperplane arrangement (see for example [BLSWZ]). We can then define the equivariant Orlik-Solomon algebra of an arbitrary oriented matroid to be the  $\mathbb{Z}_2$ -equivariant cohomology ring of its Salvetti complex. Theorem 4.1 implies that this definition agrees with our original one if the oriented matroid is realizable.

### 5. Examples

In this section we discuss three examples. In the first and third, the equivariant Orlik-Solomon algebra successfully distinguishes two arrangements with (nonequivariantly) homotopy equivalent complements. In the second example, the equivariant Orlik-Solomon algebra fails to distinguish two combinatorially distinct arrangements. In all three, we work with affine arrangements to keep dimensions as low as possible. The analogous central examples can be understood via the following proposition.

**Proposition 5.1.** *There is a  $\mathbb{Z}_2$ -equivariant diffeomorphism  $\mathcal{M}(\mathcal{CA}) \cong \mathcal{M}(\mathcal{A}) \times \mathbb{C}^*$ , and*

$$A_2(\mathcal{CA}; \mathbb{Z}_2) \cong A_2(\mathcal{A}; \mathbb{Z}_2) \otimes_{\mathbb{Z}_2[x]} \mathbb{Z}_2[x, y]/y(x - y).$$

PROOF. The standard diffeomorphism  $\mathcal{M}(\mathcal{CA}) \cong \mathcal{M}(\mathcal{A}) \times \mathbb{C}^*$ , found for example in [OT], is  $\mathbb{Z}_2$ -equivariant. The second half of the proposition is simply the statement of the equivariant Künneth theorem [Se, 7.4], combined with Example 2.7.  $\square$

**Example 5.2.** The example of Figure 1 was introduced by Falk [F1, 3.1]. The arrangements  $\mathcal{A}$  and  $\mathcal{A}'$  have nonisomorphic pointed matroids, but their complements are homotopy equivalent. In particular, they cannot be distinguished by their Orlik-Solomon algebras. We show that their equivariant Orlik-Solomon algebras are nonisomorphic, therefore the homotopy equivalence between their complements cannot be  $\mathbb{Z}_2$ -equivariant. Choose coorientations so that the intersections  $\cap_{i \leq 5} H_i^-$  are equal to the shaded regions. Then

$$A_2(\mathcal{A}; \mathbb{Z}_2) = \mathbb{Z}_2[e_1, \dots, e_5, x]/\mathcal{J} \quad \text{and} \quad A_2(\mathcal{A}'; \mathbb{Z}_2) = \mathbb{Z}_2[e_1, \dots, e_5, x]/\mathcal{J}',$$

where

$$\mathcal{J} = \left\langle e_1(x - e_1), \dots, e_5(x - e_5), e_1e_2, e_1(x - e_3)e_4, e_1e_3e_5, e_1e_4e_5, e_2e_3(x - e_4), e_2(x - e_4)(x - e_5), e_2(x - e_3)(x - e_5), e_3e_4 + e_3e_5 + e_4e_5 + e_4x \right\rangle$$

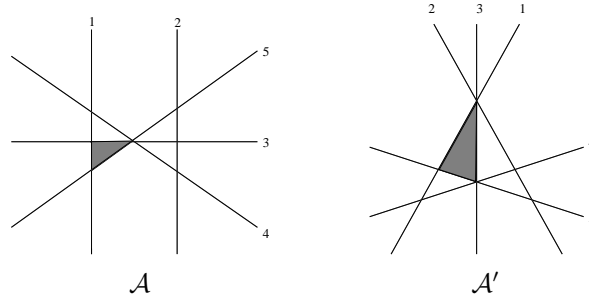

FIGURE 1. Two arrangements whose complements are homotopy equivalent, but not equivariantly.

and

$$\mathcal{J}' = \left\langle e_1(x - e_1), \dots, e_5(x - e_5), e_1e_2e_4, e_1e_2e_5, e_1e_3e_4, e_1e_3e_5, e_1e_4(x - e_5), e_2(x - e_3)e_4, e_2(x - e_3)e_5, e_2(x - e_4)e_5, e_1e_2 + e_1e_3 + e_2e_3 + e_2x, e_3e_4 + e_3e_5 + e_4e_5 + e_4x \right\rangle.$$

Using Macaulay 2 [M2], we have found that the element  $e_2 + e_3 \in A_2(\mathcal{A}'; \mathbb{Z}_2)$  has its annihilator ideal generated by  $e_4 + e_5$ ,  $e_3 + e_5 + x$ , and  $e_2e_5$ , and that no linear element in  $A_2(\mathcal{A}; \mathbb{Z}_2)$  has its annihilator ideal generated by two linear elements and one quadratic element. Hence the two graded rings are not isomorphic.

These two arrangements are generic rank 2 truncations of a pair of rank 3 arrangements  $\mathcal{A}_3$  and  $\mathcal{A}'_3$  which have diffeomorphic complements by a general construction relating parallel connections to direct sums (see [EF, Thm 2] and [F2, 3.8]). The first arrangement  $\mathcal{A}_3$  is given by the equation  $(x + 1)(x - 1)y(y + z)(y - z) = 0$ , with  $\mathcal{A}$  obtained from  $\mathcal{A}_3$  by setting  $z = x$ . The second arrangement  $\mathcal{A}'_3$  is given by the equation  $(2x + y - z)(2x - y + z)x(x - y)(x + y) = 0$ , with  $\mathcal{A}'$  obtained from  $\mathcal{A}'_3$  by setting  $z = 1$ . The diffeomorphism between  $\mathcal{M}(\mathcal{A}_3)$  and  $\mathcal{M}(\mathcal{A}'_3)$  given in [EF] is easily seen to be  $\mathbb{Z}_2$ -equivariant, as it is essentially derived from repeated applications of the diffeomorphism of Proposition 5.1. Furthermore, it is not hard to produce an explicit isomorphism between  $A_2(\mathcal{A}_3; \mathbb{Z}_2)$  and  $A_2(\mathcal{A}'_3; \mathbb{Z}_2)$ . This shows that a theorem of Pendergrass [F2, 3.11], which states that truncation of matroids preserves isomorphisms of Orlik-Solomon algebras, does not extend to the equivariant setting.

**Example 5.3.** Consider the two arrangements of lines in  $\mathbb{R}^2$  shown in Figure 2. Choose coorientations such

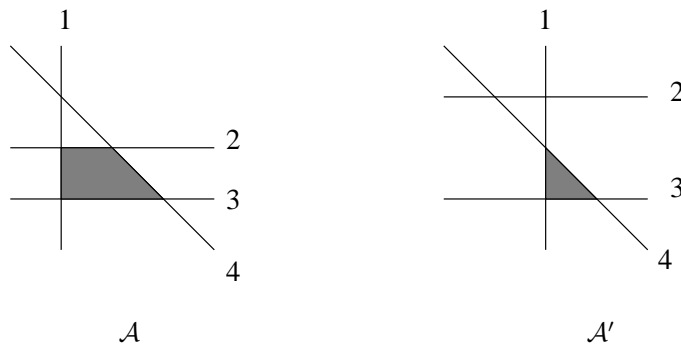

FIGURE 2. Two combinatorially distinct arrangements with isomorphic equivariant Orlik-Solomon algebras.

that the intersections  $\cap_{i \leq 4} H_i^-$  are equal to the two shaded regions. Then  $A_2(\mathcal{A}; \mathbb{Z}_2)$  is isomorphic to

$$\mathbb{Z}_2[e_1, \dots, e_4, x] / \langle e_1(x - e_1), \dots, e_4(x - e_4), e_2e_3, e_1(x - e_2)e_4, e_1e_3e_4 \rangle$$

and  $H_{\mathbb{Z}_2}^*(\mathcal{M}(A'); \mathbb{Z}_2)$  is isomorphic to

$$\mathbb{Z}_2[e_1, \dots, e_4, x] / \langle e_1(x - e_1), \dots, e_4(x - e_4), e_2e_3, (x - e_1)e_2(x - e_4), e_1e_3e_4 \rangle.$$

There is an isomorphism  $\phi : A_2(\mathcal{A}; \mathbb{Z}_2) \xrightarrow{\sim} A_2(\mathcal{A}'; \mathbb{Z}_2)$  of graded  $\mathbb{Z}_2[x]$ -modules given by the equations

$$\phi(e_1) = e_1 + e_2, \quad \phi(e_2) = e_2 + e_3 + x, \quad \phi(e_3) = e_3, \quad \text{and} \quad \phi(e_4) = e_2 + e_4.$$

The pointed oriented matroids associated to  $A$  and  $A'$  are not isomorphic, hence the equivariant Orlik-Solomon algebra is not a complete invariant.

The pointed oriented matroids corresponding to the arrangements in Example 5.3, or the oriented matroids of the cones of these two arrangements, are related by a flip. Geometrically, this means that  $\mathcal{A}'$  can be obtained from  $\mathcal{A}$  by translating one of the hyperplanes from one side of a vertex to another. (For a precise definition of flips, see [BLSWZ, §7.3].) Falk [F1] has shown that any two real line arrangements related by a flip have homotopy equivalent complements, and Example 5.3 suggests that this phenomenon might extend to the equivariant setting. The following example shows that it does not.

**Example 5.4.** Consider the two line arrangements shown in Figure 3, obtained from Example 5.3 by adding a vertical line on the far left to each arrangement.<sup>4</sup> Clearly  $\mathcal{A}$  and  $\mathcal{A}'$  are still related by a flip. We have

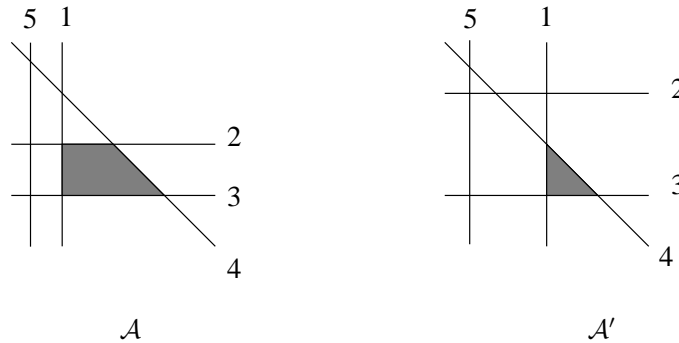

FIGURE 3. Two arrangements related by a flip with nonisomorphic Orlik-Solomon algebras.

$$A_2(\mathcal{A}; \mathbb{Z}_2) \cong \mathbb{Z}_2[\vec{e}, x] / \left\langle \begin{array}{l} e_1(x - e_1), e_2(x - e_2), e_3(x - e_3), e_4(x - e_4), \\ e_5(x - e_5), e_2e_3, (x - e_1)e_5, e_1(x - e_2)e_4, \\ e_1e_3e_4, (x - e_2)e_4e_5, e_3e_4e_5 \end{array} \right\rangle$$

and

$$A_2(\mathcal{A}'; \mathbb{Z}_2) \cong \mathbb{Z}_2[\vec{e}, x] / \left\langle \begin{array}{l} e_1(x - e_1), e_2(x - e_2), e_3(x - e_3), e_4(x - e_4), \\ e_5(x - e_5), e_2e_3, (x - e_1)e_5, (x - e_1)e_2(x - e_4), \\ e_1e_3e_4, (x - e_2)e_4e_5, e_3e_4e_5 \end{array} \right\rangle.$$

We have checked, using Macaulay 2 [M2], that the annihilator of the element  $e_2 \in A_2(\mathcal{A}; \mathbb{Z}_2)$  is generated by two linear elements (namely  $e_3$  and  $x - e_2$ ) and nothing else, while none of the (finitely many) elements of  $A_2(\mathcal{A}'; \mathbb{Z}_2)$  has this property. Hence the two rings are not isomorphic, and  $\mathcal{M}(\mathcal{A})$  is not equivariantly homotopy equivalent to  $\mathcal{M}(\mathcal{A}')$ . From this example we conclude that the equivariant Orlik-Solomon algebra of an arrangement is *not* determined by the pointed unoriented matroid.

**Problem 5.5.** In Example 5.3, are  $\mathcal{M}(\mathcal{A})$  and  $\mathcal{M}(\mathcal{A}')$  equivariantly homotopy equivalent?

<sup>4</sup>This example appeared first in [HP].

The answer is likely no, and one tool for showing this may be the *equivariant fundamental group*  $\pi_1^{\mathbb{Z}_2}(\mathcal{M}(\mathcal{A})) := \pi_1(\mathcal{M}(\mathcal{A})_{\mathbb{Z}_2})$ , where  $\mathcal{M}(\mathcal{A})_{\mathbb{Z}_2}$  is defined in Definition 2.1. This group is a semidirect product of  $\pi_1(\mathcal{M}(\mathcal{A}))$  with  $\mathbb{Z}_2$ , where  $\mathbb{Z}_2$  acts on  $\pi_1(\mathcal{M}(\mathcal{A}))$  by inverting the standard generators. Huisman [Hu] has given a presentation of this group when  $d = 2$ .

All of the arrangements that we have discussed, aside from the rank 3 arrangements to which we refer at the end of Example 5.2, have connected pointed matroids. Eschenbrenner and Falk [EF] conjecture that if  $\mathcal{A}$  is a complex central arrangement with connected matroid, then the matroid of  $\mathcal{A}$  is determined by the homotopy type of  $\mathcal{M}(\mathcal{A})$ . Assuming a negative answer to Problem 5.5, we conclude with the following analogous conjecture.

**Conjecture 5.6.** *If  $\mathcal{A}$  is a real central arrangement with connected matroid, then the oriented matroid of  $\mathcal{A}$  is determined by the equivariant homotopy type of  $\mathcal{M}(\mathcal{A})$ .*

### References

- [Bo] A. Borel. *Seminar on Transformation Groups*. Annals of Mathematical Studies 46, Princeton, 1960.
- [BLSWZ] A. Björner, M. Las Vergnas, B. Sturmfels, N. White, G. Ziegler. *Oriented Matroids*. Cambridge University Press, 1991.
- [Ca] J. Carrell. Torus actions and cohomology. *Encyclopaedia Math. Sci.*, 131, Springer, Berlin, 2002.
- [EF] C. Eschenbrenner and M. Falk. Orlik-Solomon algebras and Tutte polynomials. *J. Algebr. Comb.* 10 (1999), 189–199.
- [F1] M. Falk. Homotopy types of line arrangements. *Inv. Math.* 111 (1993), 139–150.
- [F2] M. Falk. Combinatorial and algebraic structure in Orlik-Solomon algebras. *Europ. J. Combinatorics* 22 (2001), 687–698.
- [GR] I.M. Gel'fand and G.L. Rybnikov. Algebraic and topological invariants of oriented matroids. *Soviet Math. Dokl.* 40 (1990), no. 1, 148–152.
- [HP] M. Harada and N. Proudfoot. *Properties of the residual circle action on a hypertoric variety*. To appear in Pacific J. of Math. <http://math.berkeley.edu/~proudf/ht.ps>
- [Hu] J. Huisman. Real line arrangements and fundamental groups. <http://name.math.univ-rennes1.fr/johannes.huisman/recherche/publications/rlafg.html>
- [M2] D. Grayson and M. Stillman. Macaulay 2: a computer algebra system for algebraic geometry. Version 0.8.56, [www.math.uiuc.edu/macaulay2](http://www.math.uiuc.edu/macaulay2), 1999.
- [OT] P. Orlik and H. Terao. *Arrangements of Hyperplanes*. Grundlehren der mathematischen Wissenschaften 300, Springer-Verlag, 1992.
- [Pa] L. Paris. Universal cover of Salvetti's complex and topology of simplicial arrangements of hyperplanes. *Trans. Am. Math. Soc.* 340 (1993), no. 1, 149–178.
- [Sa] M. Salvetti. Topology of the complement of real hyperplanes in  $\mathbb{C}^N$ . *Invent. Math.* 88 (1987), 603–618.
- [Se] R.M. Seymour. On  $G$ -cohomology theories and Künneth formulae. *Current trends in algebraic topology, Part 1* (London, Ontario, 1981), 257–271, CMS Conf. Proc., 2, Amer. Math. Soc., Providence, R.I., 1982.
- [VG] A.N. Varchenko and I.M. Gel'fand. Heaviside functions of a configuration of hyperplanes. *Functional Anal. Appl.* 21 (1987), no. 4, 255–270.

DEPARTMENT OF MATHEMATICS, U.C. BERKELEY, BERKELEY, USA, 94720  
*E-mail address:* proudf@math.berkeley.edu



## A Polynomiality Property for Littlewood-Richardson Coefficients

Etienne Rassart

**Abstract.** We present a polynomiality property of the Littlewood-Richardson coefficients  $c_{\lambda\mu}^\nu$ . The coefficients are shown to be given by polynomials in  $\lambda$ ,  $\mu$  and  $\nu$  on the cones of the chamber complex of a vector partition function. We give bounds on the degree of the polynomials depending on the maximum allowed number of parts of the partitions  $\lambda$ ,  $\mu$  and  $\nu$ . We first express the Littlewood-Richardson coefficients as a vector partition function. We then define a hyperplane arrangement from Steinberg's formula, over whose regions the Littlewood-Richardson coefficients are given by polynomials, and relate this arrangement to the chamber complex of the partition function. As an easy consequence, we get a new proof of the fact that  $c_{N\lambda N\mu}^{N\nu}$  is given by a polynomial in  $N$ , which partially establishes the conjecture of King, Tollu and Toumazet [KTT03] that  $c_{N\lambda N\mu}^{N\nu}$  is a polynomial in  $N$  with nonnegative rational coefficients.

**Résumé.** Nous présentons une propriété de polynomialité des coefficients de Littlewood-Richardson  $c_{\lambda\mu}^\nu$ . Nous démontrons que ces coefficients sont donnés par des fonctions polynomiales en  $\lambda$ ,  $\mu$  et  $\nu$  dans les cônes du complexe d'une fonction de partition vectorielle. Nous donnons des bornes sur les degrés de ces polynômes en termes du nombre de parts des partitions  $\lambda$ ,  $\mu$  and  $\nu$ . Nous exprimons premièrement les coefficients de Littlewood-Richardson en termes d'une fonction de partition vectorielle. Nous définissons ensuite un arrangement d'hyperplans à partir de la formule de Steinberg, sur les régions duquel les coefficients de Littlewood-Richardson sont donnés par des polynômes, puis faisons le lien entre cet arrangement et le complexe de cônes de la fonction de partition vectorielle. Comme conséquence simple, nous obtenons une preuve élémentaire du fait que  $c_{N\lambda N\mu}^{N\nu}$  est donné par un polynôme en  $N$ , ce qui établit partiellement une conjecture de King, Tollu et Toumazet [KTT03], voulant que  $c_{N\lambda N\mu}^{N\nu}$  soit un polynôme en  $N$  avec des coefficients rationnels nonnégatifs.

### 1. Introduction

Littlewood-Richardson coefficients appear in many fields of mathematics. In combinatorics, they appear in the theory of symmetric functions (see [Mac95, Sta99]). The Schur symmetric functions form a linear basis of the ring of symmetric functions, and the Littlewood-Richardson coefficients express the multiplication rule,

$$(1.1) \quad s_\lambda \cdot s_\mu = \sum_{\nu} c_{\lambda\mu}^\nu s_\nu,$$

---

1991 *Mathematics Subject Classification.* Primary 05E15; Secondary 05E05, 52B20.

*Key words and phrases.* algebraic combinatorics, tensor product multiplicities, vector partition functions.

as well as how to write skew Schur functions in terms of the Schur function basis:

$$(1.2) \quad s_{\nu/\lambda} = \sum_{\mu} c_{\lambda\mu}^{\nu} s_{\mu}.$$

In the representation theory of the general and special linear groups, the characters of the irreducible polynomial representations of  $\mathrm{GL}_k\mathbb{C}$  are Schur functions in appropriate variables [FH91, Mac95]. As such, the Littlewood-Richardson coefficient  $c_{\lambda\mu}^{\nu}$  gives the multiplicity with which the irreducible representation  $V_{\nu}$  of  $\mathrm{GL}_k\mathbb{C}$  appears in the tensor product of the irreducible representations  $V_{\lambda}$  and  $V_{\mu}$ :

$$(1.3) \quad V_{\lambda} \otimes V_{\mu} = \bigoplus_{\nu} c_{\lambda\mu}^{\nu} V_{\nu}.$$

Littlewood-Richardson coefficients also appear in algebraic geometry: Schubert classes form a linear basis of the cohomology ring of the Grassmannian, and the Littlewood-Richardson coefficients again express the multiplication rule [Ful97]:

$$(1.4) \quad \sigma_{\lambda} \cdot \sigma_{\mu} = \sum_{\nu} c_{\lambda\mu}^{\nu} \sigma_{\nu}.$$

In previous work with Billey and Guillemin [BGR03], we studied the Kostka numbers  $K_{\lambda\mu}$ , which appear when expressing the Schur function  $s_{\lambda}$  in terms of the monomial symmetric functions:  $s_{\lambda} = \sum_{\mu} K_{\lambda\mu} m_{\mu}$ . Kostka numbers also give the weight multiplicities in the weight space decomposition  $V_{\lambda} = \bigoplus_{\mu} (V_{\lambda})_{\mu}$  of the irreducible representation  $V_{\lambda}$  of  $\mathfrak{sl}_k\mathbb{C}$ :

$$(1.5) \quad K_{\lambda\mu} = \dim (V_{\lambda})_{\mu}.$$

We showed there that the Kostka numbers are given by a vector partition function and that this implies that the function  $(\lambda, \mu) \mapsto K_{\lambda\mu}$  is quasipolynomial in the cones of a chamber complex. We then defined a hyperplane arrangement, the Kostant arrangement, over whose regions this function was given by a polynomial. This allowed us to prove that the quasipolynomial in the cones were actually polynomials. As a corollary, we obtained an alternative proof to that of Kirillov that the function  $N \mapsto K_{N\lambda N\mu}$  is a polynomial in  $N$  for every fixed  $\lambda$  and  $\mu$ .

In [KTT03], King, Tollu and Toumazet conjecture that the Littlewood-Richardson coefficients exhibit a similar “stretching” property:

**Conjecture 1.1. (King, Tollu, Toumazet [KTT03])** *For all partitions  $\lambda, \mu$  and  $\nu$  such that  $c_{\lambda\mu}^{\nu} > 0$  there exists a polynomial  $P_{\lambda\mu}^{\nu}(N)$  in  $N$  with nonnegative rational coefficients such that  $P_{\lambda\mu}^{\nu}(0) = 1$  and  $P_{\lambda\mu}^{\nu}(N) = c_{N\lambda N\mu}^{N\nu}$  for all positive integers  $N$ .*

In [DW02], Derksen and Weyman prove the polynomiality part of this conjecture using semi-invariants of quivers. They call the functions  $P_{\lambda\mu}^{\nu}(N)$  (for fixed  $\lambda, \mu$  and  $\nu$ ), *Littlewood-Richardson polynomials*.

Here we extend the results of [BGR03] to the case of Littlewood-Richardson coefficients. We first express Littlewood-Richardson coefficients as a vector partition function (Theorem 2.3). This is done using a combinatorial model (the hive model [Buc00, KT99]) for computing the Littlewood-Richardson coefficients. This means that these coefficients are quasipolynomial in  $\lambda, \mu$  and  $\nu$  over the conical cells of a chamber complex  $\mathcal{LR}_k$ .

From Steinberg’s formula [Ste61], giving the multiplicities with which irreducible representations appear in the decomposition into irreducibles of the tensor product of two irreducible representations of a complex semisimple Lie algebra, we then define a hyperplane arrangement, the Steinberg arrangement  $\mathcal{SA}_k$ . We show that the Littlewood-Richardson coefficients are given by a polynomial over the regions of this arrangement (Proposition 3.3).

Finally, by comparing the chamber complex  $\mathcal{LR}_k$  with the Steinberg arrangement  $\mathcal{SA}_k$ , we are able to show that the quasipolynomial in the cones of  $\mathcal{LR}_k$  are actually polynomials in  $\lambda, \mu$  and  $\nu$ , and we provide degree bounds (Theorem 4.1). Because we are working in cones, this provides an alternative proof to that of

[DW02] of the polynomiality part of the conjecture of King, Tollu and Toumazet; we don't know whether the polynomials  $P_{\lambda\mu}^\nu$  have nonnegative coefficients or not. However, we get global polynomiality results in a chamber complex instead of polynomiality on fixed rays. We understand that Knutson [Knu03] also proved polynomiality in cones using symplectic geometry techniques.

**1.1. Type A root systems and Littlewood-Richardson coefficients.** The simple Lie algebra  $\mathfrak{sl}_k\mathbb{C}$  (of type  $A_{k-1}$ ) is the subalgebra of  $\mathfrak{gl}_k\mathbb{C} \cong \text{End}(\mathbb{C}^k)$  consisting of traceless  $k \times k$  matrices over  $\mathbb{C}$ . We will take as its Cartan subalgebra  $\mathfrak{h}$  its subspace of traceless diagonal matrices. The roots and weights live in the dual  $\mathfrak{h}^*$  of  $\mathfrak{h}$ , which can be identified with the subspace  $x_1 + \dots + x_k = 0$  of  $\mathbb{R}^k$ . The roots are  $\{e_i - e_j : 1 \leq i \neq j \leq k\}$ , and we will choose the positive ones to be  $\Delta_+ = \{e_i - e_j : 1 \leq i < j \leq k\}$ . The simple roots are then  $\alpha_i = e_i - e_{i+1}$ , for  $1 \leq i \leq k - 1$ , and for these simple roots, the fundamental weights are

$$(1.6) \quad \omega_i = \frac{1}{k} \left( \underbrace{k-i, k-i, \dots, k-i}_i \text{ times}, \underbrace{-i, -i, \dots, -i}_{k-i} \text{ times} \right), \quad 1 \leq i \leq k-1.$$

The fundamental weights are defined such that  $\langle \alpha_i, \omega_j \rangle = \delta_{ij}$ , where  $\langle \cdot, \cdot \rangle$  is the usual dot product. The integral span of the simple roots and the fundamental weights are the root lattice  $\Lambda_R$  and the weight lattice  $\Lambda_W$  respectively. The root lattice is a finite index sublattice of the weight lattice, with index  $k - 1$ .

For our choice of positive roots,  $\delta = \frac{1}{2} \sum_{\alpha \in \Delta_+} \alpha = \sum_{j=1}^{k-1} \omega_j = \frac{1}{2}(k-1, k-3, \dots, -(k-3), -(k-1))$ . The Weyl group for  $\mathfrak{sl}_k\mathbb{C}$  is the symmetric group  $\mathfrak{S}_k$  acting on  $\{e_1, \dots, e_k\}$  (i.e.  $\sigma(e_i) = e_{\sigma(i)}$ ), and with the choice of positive roots we made, the fundamental Weyl chamber will be  $C_0 = \{(\lambda_1, \dots, \lambda_k) : \sum_{i=1}^k \lambda_i = 0 \text{ and } \lambda_1 \geq \dots \geq \lambda_k\}$ . The action of the Weyl group preserves the root and weight lattices. Weights lying in the fundamental Weyl chamber are called *dominant*, and we will call elements of the Weyl orbits of the fundamentals weights *conjugates of fundamental weights*.

The finite dimensional representations of  $\mathfrak{sl}_k\mathbb{C}$ , or  $\text{SL}_k\mathbb{C}$ , are indexed by the dominant weights  $\Lambda_W \cap C_0$ , and for a given dominant weight  $\lambda$ , there is a unique irreducible representation  $\rho_\lambda : \mathfrak{sl}_k\mathbb{C} \rightarrow \mathfrak{gl}(V_\lambda)$  with highest weight  $\lambda$ , up to isomorphism. The finite dimensional polynomial representations of  $\mathfrak{gl}_k\mathbb{C}$ , or  $\text{GL}_k\mathbb{C}$ , are indexed by partitions with at most  $k$  parts, that is by sequences  $(\lambda_1, \dots, \lambda_k)$  of integers satisfying  $\lambda_1 \geq \dots \geq \lambda_k \geq 0$ . Two irreducible representations  $V_\lambda$  and  $V_\mu$  of  $\mathfrak{gl}_k\mathbb{C}$  restrict to the same irreducible representation of  $\mathfrak{sl}_k\mathbb{C}$  if  $\lambda_i - \mu_i$  is some constant independent of  $i$  for all  $i$ . So the irreducible representations of  $\mathfrak{sl}_k\mathbb{C}$  correspond to equivalence classes of irreducible representations of  $\mathfrak{gl}_k\mathbb{C}$ . Consider the map  $\lambda \mapsto \bar{\lambda}$  given by

$$(1.7) \quad (\lambda_1, \dots, \lambda_k) \longmapsto (\lambda_1, \dots, \lambda_k) - \frac{\sum \lambda_i}{k} \underbrace{(1, 1, \dots, 1)}_{k \text{ times}}.$$

Then the representations  $V_\lambda$  of  $\mathfrak{gl}_k\mathbb{C}$  restricts to the irreducible representation  $V_{\bar{\lambda}}$  of  $\mathfrak{sl}_k\mathbb{C}$ . Details about the construction of the irreducible representations of  $\text{SL}_k\mathbb{C}$  and  $\text{GL}_k\mathbb{C}$  are well-known and can be found in [Ful97] or [FH91], for example. We will denote by  $|\lambda|$  the sum  $\sum \lambda_i$  (so  $\lambda$  is a partition of the integer  $|\lambda|$ ). We will also let  $l(\lambda)$  denote the number of nonzero parts of  $\lambda$ .

Given two irreducible representations  $V_\lambda$  and  $V_\mu$  of  $\text{GL}_k\mathbb{C}$ , their tensor product  $V_\lambda \otimes V_\mu$  is again a representation of  $\text{GL}_k\mathbb{C}$ , and we can decompose it in terms of irreducibles of  $\text{GL}_k\mathbb{C}$ :

$$(1.8) \quad V_\lambda \otimes V_\mu = \bigoplus_{\nu} c_{\lambda\mu}^\nu V_\nu,$$

where  $c_{\lambda\mu}^\nu V_\nu = V_\nu^{\oplus c_{\lambda\mu}^\nu}$ , for some nonnegative integer numbers  $c_{\lambda\mu}^\nu$ , called the *Littlewood-Richardson coefficients*. The direct sum ranges over all partitions  $\nu$ , but  $c_{\lambda\mu}^\nu = 0$  unless  $|\lambda| + |\mu| = |\nu|$  and  $\lambda$  and  $\mu$  are

contained in  $\nu$ . We have a similar decomposition for the tensor product of two irreducible representations of  $\mathfrak{sl}_k\mathbb{C}$ :

$$(1.9) \quad V_{\bar{\lambda}} \otimes V_{\bar{\mu}} = \bigoplus_{\bar{\nu}} m_{\bar{\lambda}\bar{\mu}}^{\bar{\nu}} V_{\bar{\nu}},$$

for nonnegative integers  $m_{\bar{\lambda}\bar{\mu}}^{\bar{\nu}}$ , where the sum ranges over all dominant weights  $\bar{\nu} \in C_0$ .

There is a general formula due to Steinberg [Hum72, Ste61] giving the multiplicity with which an irreducible representation  $V_{\nu}$  occurs in the tensor product of two irreducible representations  $V_{\lambda}$  and  $V_{\mu}$  of a complex semisimple Lie algebra. This will give us a way of computing the  $m_{\bar{\lambda}\bar{\mu}}^{\bar{\nu}}$ , and also the  $c_{\lambda\mu}^{\nu}$ , but first we have to define the Kostant partition function.

**Definition 1.2.** The *Kostant partition function* for a root system  $\Delta$ , given a choice of positive roots  $\Delta_+$ , is the function

$$(1.10) \quad K(v) = \left| \left\{ (k_{\alpha})_{\alpha \in \Delta_+} \in \mathbb{N}^{|\Delta_+|} : \sum_{\alpha \in \Delta_+} k_{\alpha} \alpha = v \right\} \right|,$$

i.e.  $K(v)$  is the number of ways that  $v$  can be written as a sum of positive roots.

**Theorem 1.3. (Steinberg [Ste61])**

$$(1.11) \quad m_{\bar{\lambda}\bar{\mu}}^{\bar{\nu}} = \sum_{\sigma \in \mathfrak{S}_k} \sum_{\tau \in \mathfrak{S}_k} (-1)^{\text{inv}(\sigma\tau)} K(\sigma(\bar{\lambda} + \delta) + \tau(\bar{\mu} + \delta) - (\bar{\nu} + 2\delta)),$$

where  $\text{inv}(\psi)$  is the number of inversions of the permutation  $\psi$ .

Restricting equation (1.8) to  $\text{SL}_k\mathbb{C}$ , we get

$$(1.12) \quad V_{\bar{\lambda}} \otimes V_{\bar{\mu}} = \sum_{\nu} c_{\lambda\mu}^{\nu} V_{\bar{\nu}},$$

and comparing with (1.9) gives

$$(1.13) \quad c_{\lambda\mu}^{\nu} = m_{\bar{\lambda}\bar{\mu}}^{\bar{\nu}}.$$

Hence Steinberg's formula also computes the Littlewood-Richardson coefficients, and we can further simplify things by noticing that if we let  $\mathbf{1}_k$  denote the vector  $(1, 1, \dots, 1) \in \mathbb{R}^k$ , then

$$\begin{aligned} & \sigma(\bar{\lambda} + \delta) + \tau(\bar{\mu} + \delta) - (\bar{\nu} + 2\delta) \\ &= \sigma(\bar{\lambda}) + \tau(\bar{\mu}) - \bar{\nu} + \sigma(\delta) + \tau(\delta) - 2\delta \\ &= \sigma\left(\lambda - \frac{|\lambda|}{k} \mathbf{1}_k\right) + \tau\left(\mu - \frac{|\mu|}{k} \mathbf{1}_k\right) - \left(\nu - \frac{|\nu|}{k} \mathbf{1}_k\right) + \sigma(\delta) + \tau(\delta) - 2\delta \\ &= \sigma(\lambda) - \frac{|\lambda|}{k} \mathbf{1}_k + \tau(\mu) - \frac{|\mu|}{k} \mathbf{1}_k - \nu + \frac{|\nu|}{k} \mathbf{1}_k + \sigma(\delta) + \tau(\delta) - 2\delta \\ &= \sigma(\lambda + \delta) + \tau(\mu + \delta) - (\nu + 2\delta) + \frac{1}{k} (|\nu| - |\lambda| - |\mu|) \mathbf{1}_k \\ &= \sigma(\lambda + \delta) + \tau(\mu + \delta) - (\nu + 2\delta). \end{aligned}$$

In view of (1.11) and (1.13), this gives

$$(1.14) \quad c_{\lambda\mu}^{\nu} = \sum_{\sigma \in \mathfrak{S}_k} \sum_{\tau \in \mathfrak{S}_k} (-1)^{\text{inv}(\sigma\tau)} K(\sigma(\lambda + \delta) + \tau(\mu + \delta) - (\nu + 2\delta)).$$

In Section 3, we will use this formula to define a hyperplane arrangement over whose regions the Littlewood-Richardson coefficients are given by polynomials in  $\lambda$ ,  $\mu$  and  $\nu$ .

**1.2. Partition functions and chamber complexes.** Partition functions arise in the representation theory of the semisimple Lie algebras in the form of Kostant’s partition function, which sends a vector in the root lattice to the number of ways it can be written down as a linear combination with nonnegative integer coefficients of the positive roots. The Kostant partition function is a simple example of a more general class of functions, called *vector partition functions*.

**Definition 1.4.** Let  $M$  be a  $d \times n$  matrix over the integers, such that  $\ker M \cap \mathbb{R}_{\geq 0}^n = 0$ . The *vector partition function* (or simply *partition function*) associated to  $M$  is the function

$$\begin{aligned} \phi_M : \mathbb{Z}^d &\longrightarrow \mathbb{N} \\ b &\mapsto |\{x \in \mathbb{N}^n : Mx = b\}| \end{aligned}$$

The condition  $\ker M \cap \mathbb{R}_{\geq 0}^n = 0$  forces the set  $\{x \in \mathbb{N}^n : Mx = b\}$  to have finite size, or equivalently, the set  $\{x \in \mathbb{R}_{\geq 0}^n : Mx = b\}$  to be compact, in which case it is a polytope  $P_b$ , and the partition function is the number of integral points (lattice points) inside it.

Also, if we let  $M_1, \dots, M_n$  denote the columns of  $M$  (as column-vectors), and  $x = (x_1, \dots, x_n) \in \mathbb{R}_{\geq 0}^n$ , then  $Mx = x_1M_1 + x_2M_2 + \dots + x_nM_n$  and for this to be equal to  $b$ ,  $b$  has to lie in the cone  $\text{pos}(M)$  spanned by the vectors  $M_i$ . So  $\phi_M$  vanishes outside of  $\text{pos}(M)$ .

It is well-known that partition functions are piecewise quasipolynomial, and that the domains of quasipolynomiality form a complex of convex polyhedral cones, called the *chamber complex*. Sturmfels gives a very clear explanation in [Stu95] of this phenomenon. The explicit description of the chamber complex is due to Alekseevskaya, Gel’fand and Zelevinskii [AGZ98]. There is a special class of matrices for which partition functions take a much simpler form. Call an integer  $d \times n$  matrix  $M$  of full rank  $d$  *unimodular* if every nonsingular  $d \times d$  submatrix has determinant  $\pm 1$ . For unimodular matrices, the chamber complex determines domains of polynomiality instead of quasipolynomiality [Stu95].

It is useful for what follows to describe how to obtain the chamber complex of a partition function. Let  $M$  be a  $d \times n$  integer matrix of full rank  $d$  and  $\phi_M$  its associated partition function. For any subset  $\sigma \subseteq \{1, \dots, n\}$ , denote by  $M_\sigma$  the submatrix of  $M$  with column set  $\sigma$ , and let  $\tau_\sigma = \text{pos}(M_\sigma)$ , the cone spanned by the columns of  $M_\sigma$ . Define the set  $\mathcal{B}$  of *bases* of  $M$  to be

$$\mathcal{B} = \{\sigma \subseteq \{1, \dots, n\} : |\sigma| = d \text{ and } \text{rank}(M_\sigma) = d\}.$$

$\mathcal{B}$  indexes the invertible  $d \times d$  submatrices of  $M$ . The *chamber complex* of  $\phi_M$  is the common refinement of all the cones  $\tau_\sigma$ , as  $\sigma$  ranges over  $\mathcal{B}$  (see [AGZ98]). A theorem of Sturmfels [Stu95] describes exactly how partition functions are quasipolynomial over the chambers of that complex.

If we let  $M_{A_n}$  be the matrix whose columns are the positive roots  $\Delta_+^{(A_n)}$  of  $A_n$ , written in the basis of simple roots, then we can write Kostant’s partition function in the matrix form defined above as

$$K_{A_n}(v) = \phi_{M_{A_n}}(v).$$

The following lemma is a well-known fact about  $M_{A_n}$  and can be deduced from general results on matrices with columns of 0’s and 1’s where the 1’s come in a consecutive block (see [Sch86]).

**Lemma 1.5.** *The matrix  $M_{A_n}$  is unimodular for all  $n$ .*

$M_{A_n}$  unimodular means that the Kostant partition functions for  $A_n$  is polynomial instead of quasipolynomial on the cells of the chamber complex. In general, for  $M$  unimodular, the polynomial pieces have degree at most the number of columns of the matrix minus its rank (see [Stu95]). In our case,  $M_{A_n}$  has rank  $n$  and as many columns as  $A_n$  has positive roots,  $\binom{n+1}{2}$ . Hence the Kostant partition function for  $A_n$  is piecewise polynomial of degree at most  $\binom{n+1}{2} - n = \binom{n}{2}$ .

**Remark 1.6.** In view of Steinberg’s formula (1.11), this means that the Littlewood-Richardson coefficients are given by a piecewise polynomial function of degree at most  $\binom{n}{2}$  in the three sets of variables  $\lambda$ ,  $\mu$  and  $\nu$ , if these partitions have at most  $n + 1$  parts. This will be made precise in Sections 3 and 4

**2. A vector partition function for the Littlewood-Richardson coefficients**

There are many combinatorial ways to compute the Littlewood-Richardson coefficients, in particular the Littlewood-Richardson rule [Sta99], honeycombs [KT99] and Berenstein-Zelevinsky triangles [BZ92]. The model that is most convenient for us is the hive model [Buc00, KT99].

**Definition 2.1.** A *k-hive* is an array of numbers  $a_{ij}$  with  $0 \leq i, j \leq k$  and  $i + j \leq k$ . We will represent hives in matrix form. For example, a 4-hive is

$$\begin{array}{cccc}
 a_{00} & a_{01} & a_{02} & a_{03} & a_{04} \\
 & a_{10} & a_{11} & a_{12} & a_{13} \\
 & & a_{20} & a_{21} & a_{22} \\
 & & & a_{30} & a_{31} \\
 & & & & a_{40}
 \end{array}
 \tag{2.1}$$

We will call a hive *integral* if all its entries are nonnegative integers. Following the terminology of [KTT03], we will call *hive conditions* (HC) the conditions

$$\begin{array}{ccc}
 \begin{array}{ccc} & j & j+1 \\ & \bullet & \boxed{\bullet} \\ i & & \\ & i+1 & \boxed{\bullet} \bullet \end{array} &
 \begin{array}{ccc} & j & j+1 \\ & i & \bullet \\ i+1 & \boxed{\bullet} & \boxed{\bullet} \\ & i+2 & \bullet \end{array} &
 \begin{array}{ccc} & j & j+1 & j+2 \\ & i & \boxed{\bullet} & \bullet \\ i+1 & \bullet & \boxed{\bullet} \end{array}
 \end{array}
 \tag{2.2}$$

where in each diagram, the sum of the boxed entries is at least as large as the sum of the other two entries. In terms of the  $a_{ij}$ , (HC) is

$$a_{i+1j} + a_{ij+1} \geq a_{ij} + a_{i+1j+1}
 \tag{2.3}$$

$$a_{i+1j} + a_{i+1j+1} \geq a_{i+2j} + a_{ij+1}
 \tag{2.4}$$

$$a_{ij+1} + a_{i+1j+1} \geq a_{i+1j} + a_{ij+2}
 \tag{2.5}$$

for  $i + j \leq k - 2$ .

**Proposition 2.2.** (Knutson-Tao [KT99], Fulton [Buc00]) *For  $\lambda, \mu$  and  $\nu$  partitions with at most  $k$  parts and  $|\lambda| + |\mu| = |\nu|$ , the Littlewood-Richardson coefficient  $c_{\lambda\mu}^\nu$  is the number of integral  $k$ -hives satisfying (HC) and the boundary conditions*

$$\begin{array}{ll}
 a_{00} = 0, & \\
 a_{0j} = \lambda_1 + \dots + \lambda_j & 1 \leq j \leq k \\
 a_{i0} = \nu_1 + \dots + \nu_i & 1 \leq i \leq k \\
 a_{m,k-m} = |\lambda| + \mu_1 + \dots + \mu_m & 1 \leq m \leq k.
 \end{array}
 \tag{2.6}$$

Once the boundary conditions are imposed, we are left with a system of inequalities in the nonnegative integral variables  $a_{ij}$  for  $1 \leq i, j \leq k - 1$  and  $i + j \leq k - 1$ . There are  $n(k) = 3 \binom{k}{2}$  inequalities. If we let these  $a_{ij}$  take real values, the inequalities define a rational polytope  $Q_{\lambda\mu}^\nu$ , and the Littlewood-Richardson coefficient corresponding to the boundary conditions is the number of integral (lattice) points inside  $Q_{\lambda\mu}^\nu$ .

Given a  $d$ -dimensional rational polytope  $Q$  in  $\mathbb{R}^n$ , we will denote by  $mQ$  the polytope  $Q$  blown up by a factor of  $m$ . The function  $m \in \mathbb{N} \mapsto |mQ \cap \mathbb{Z}^n|$  is called the *Ehrhart function* of  $Q$ , and is known [Ehr77, Sta99] to be a quasipolynomial of degree  $d$  in  $m$ . Furthermore, if  $Q$  is integral, the Ehrhart function is a degree  $d$  polynomial in  $m$ . This means that the function

$$(2.7) \quad N \longmapsto c_{N\lambda N\mu}^{N\nu}$$

is the Ehrhart quasipolynomial of the polytope  $Q_{\lambda\mu}^\nu$ . It is known that  $Q_{\lambda\mu}^\nu$  is not integral in general (see examples in [KTT03]).

This describes the behavior of the Littlewood-Richardson coefficients on a ray in  $(\lambda, \mu, \nu)$ -space, but we will get more general results by showing that we can find a vector partition function that gives these coefficients. We will then be able to work with conical chambers in  $(\lambda, \mu, \nu)$ -space instead of simple rays. This is accomplished in a way very similar to the one introduced for the weight multiplicities in [BGR03], and this case is even simpler because the variables  $a_{ij}$  are already constrained to be nonnegative.

**Theorem 2.3.** *There are integer matrices  $E_k$  and  $B_k$  such that the function  $(\lambda, \mu, \nu) \mapsto c_{\lambda\mu}^\nu$  for  $\lambda, \mu, \nu$  partitions with at most  $k$  parts such that  $|\lambda| + |\mu| = |\nu|$  and  $\lambda, \mu \subseteq \nu$  is given by*

$$(2.8) \quad c_{\lambda\mu}^\nu = \phi_{E_k} \left( B_k \begin{pmatrix} \lambda \\ \mu \\ \nu \end{pmatrix} \right).$$

The chamber complex defined by  $E_k$  is much too big for our purposes. For one thing, its cones have dimension  $n(k) = 3\binom{k}{2}$ , whereas  $(\lambda, \mu, \nu)$ -space is  $3k$ -dimensional. To simplify things, we can first restrict ourselves with the intersection of the complex of  $E_k$  with the subspace

$$(2.9) \quad \mathcal{B}^{(k)} = \left\{ \left( B_k \begin{pmatrix} \lambda \\ \mu \\ \nu \end{pmatrix} \right) : \lambda, \mu, \nu \in \mathbb{R}^k \right\}$$

of  $\mathbb{R}^{n(k)}$  to get a complex  $\mathcal{C}_k$ . Then we can pull back the cones along the transformation  $B_k$  to  $(\lambda, \mu, \nu)$ -space. Cones in  $\mathcal{B}^{(k)}$  are given by inequalities of the form

$$\left\langle v_i, B_k \begin{pmatrix} \lambda \\ \mu \\ \nu \end{pmatrix} \right\rangle \geq 0$$

for some directions  $v_i \in \mathbb{R}^{n(k)}$ . But

$$\left\langle v_i, B_k \begin{pmatrix} \lambda \\ \mu \\ \nu \end{pmatrix} \right\rangle \geq 0 \quad \Leftrightarrow \quad \left\langle B_k^T v_i, \begin{pmatrix} \lambda \\ \mu \\ \nu \end{pmatrix} \right\rangle \geq 0,$$

where  $B_k^T$  is the transpose of  $B_k$ . So we can pull back the cones to get a complex  $B_k^* \mathcal{C}_k$  in  $(\lambda, \mu, \nu)$ -space. As a final simplification, we can note that  $c_{\lambda\mu}^\nu = 0$  unless  $\lambda, \mu \subseteq \nu$  and  $|\lambda| + |\mu| = |\nu|$  and that these conditions define a cone  $C_k^{(1)}$  since the containment equations can be written  $\lambda_i, \mu_i \leq \nu_i$  for  $1 \leq i \leq k$ . The conditions  $\lambda_1 \geq \dots \geq \lambda_k \geq 0, \mu_1 \geq \dots \geq \mu_k \geq 0$  and  $\nu_1 \geq \dots \geq \nu_k \geq 0$  also define a cone  $C_k^{(2)}$ .

**Definition 2.4.** We will call the intersection of the cones  $C_k^{(1)}$  and  $C_k^{(2)}$  with the rectified complex  $B_k^* \mathcal{C}_k$  the *Littlewood-Richardson complex*, and denote it  $\mathcal{LR}_k$ . This complex lives on the subspace  $|\lambda| + |\mu| = |\nu|$  of  $\mathbb{R}^{3k}$ .

As a result of the general theory of vector partition functions, we get the following corollary.

**Corollary 2.5.** *Under the conditions of the theorem above, the function  $(\lambda, \mu, \nu) \mapsto c_{\lambda\mu}^\nu$  is quasipolynomial of degree at most  $3\binom{k}{2} + n(k) - \text{rank } E_k = 3\binom{k}{2}$  over the chambers of the complex  $\mathcal{LR}_k$ .*

We will explain in Section 4 that we actually get polynomials in the chambers.

It rapidly becomes computationally hard to work out the chamber complex and the associated polynomials; we present an example of how the computations are done on the simplest nontrivial example,  $k = 3$ , in Section 5.

### 3. The Steinberg arrangement

In this section, we will construct a hyperplane arrangement whose regions are domains of polynomiality for the Littlewood-Richardson coefficients. We will deduce the form of this arrangement from a closer look at Steinberg’s formula (1.11) and the chamber complex of the Kostant partition function defined in Section 1.2.

The following lemma describes the set of normals to the hyperplanes supporting the cells of the chamber complex for the Kostant partition function.

**Lemma 3.1.** *The set of normals to the facets of the maximal cones of the chamber complex of the Kostant partition function of  $A_n$  consists of all the conjugates of the fundamental weights.*

To compute the Littlewood-Richardson coefficients using Steinberg’s formula (1.11), we look at the points  $\sigma(\lambda + \delta) + \tau(\mu + \delta) - (\nu + 2\delta)$ , as  $\sigma$  and  $\tau$  range over the Weyl group  $\mathfrak{S}_k$  (we assume here that  $\lambda, \mu$  and  $\nu$  have at most  $k$  parts and index irreducible representations of  $\text{GL}_k(\mathbb{C})$ ). Some of these points will lie inside the chamber complex for the Kostant partition function and we compute the Littlewood-Richardson coefficients by finding which cells contain them and evaluating the corresponding polynomials at those points. We will call  $(\lambda, \mu, \nu)$  *generic* if none of the points  $\sigma(\lambda + \delta) + \tau(\mu + \delta) - (\nu + 2\delta)$  lies on a wall of the chamber complex of the Kostant partition function. If we change a generic  $(\lambda, \mu, \nu)$  to  $(\lambda', \mu', \nu')$  on the hyperplane  $|\lambda| + |\mu| = |\nu|$  in such a way that none of the  $\sigma(\lambda + \delta) + \tau(\mu + \delta) - (\nu + 2\delta)$  crosses a wall, we will obtain  $c_{\lambda'\mu'}^{\nu'}$  by evaluating the same polynomials. So there is a neighborhood of  $(\lambda, \mu, \nu)$  on which the Littlewood-Richardson coefficients are given by the same polynomial in the variables  $\lambda, \mu$  and  $\nu$ .

Lemma 3.1 describes the walls of the chamber complex for the Kostant partition function in terms of the normals to the hyperplanes (through the origin) supporting the facets of the maximal cells. Now a point  $\sigma(\lambda + \delta) + \tau(\mu + \delta) - (\nu + 2\delta)$  will be on one of those walls (hyperplane through the origin) when its scalar product with the hyperplane’s normal, say  $\theta(\omega_j)$ , vanishes, that is when

$$(3.1) \quad \langle \sigma(\lambda + \delta) + \tau(\mu + \delta) - (\nu + 2\delta), \theta(\omega_j) \rangle = 0$$

Consider the arrangement on the subspace  $|\lambda| + |\mu| = |\nu|$  of  $\mathbb{R}^{3k}$  consisting of all such hyperplanes, for  $1 \leq j \leq k$  and  $\sigma, \tau, \theta \in \mathfrak{S}_k$ . For  $(\lambda, \mu, \nu)$  and  $(\lambda', \mu', \nu')$  in the same region of this arrangement and any fixed  $\sigma, \tau \in \mathfrak{S}_k$ , the points  $\sigma(\lambda + \delta) + \tau(\mu + \delta) - (\nu + 2\delta)$  and  $\sigma(\lambda' + \delta) + \tau(\mu' + \delta) - (\nu' + 2\delta)$  lie on the same side of every wall of the chamber complex for the Kostant partition function. We will call this arrangement the *Steinberg arrangement*, and denote it  $\mathcal{SA}_k$ .

**Definition 3.2.** Fix a labelling on the chambers of the complex for the Kostant partition function, and let  $p_1, p_2, \dots$  be the polynomials associated to the chambers. For generic  $\lambda, \mu$  and  $\nu$ , let  $v_{\sigma\tau}(\lambda, \mu, \nu)$  be the label of the region containing the point  $\sigma(\lambda + \delta) + \tau(\mu + \delta) - (\nu + 2\delta)$  (this label is unique for generic  $\lambda, \mu$  and  $\nu$ ). Define the *type* of  $\lambda, \mu$  and  $\nu$  to be the matrix

$$\text{Type}(\lambda, \mu, \nu) = (v_{\sigma\tau}(\lambda, \mu, \nu))_{\sigma, \tau \in \mathfrak{S}_k},$$

for some fixed total order on  $\mathfrak{S}_k$ . Furthermore, define

$$(3.2) \quad P(\lambda, \mu, \nu) = \sum_{\sigma \in \mathfrak{S}_k} \sum_{\tau \in \mathfrak{S}_k} (-1)^{\text{inv}(\sigma\tau)} p_{v_{\sigma\tau}}(\sigma(\lambda + \delta) + \tau(\mu + \delta) - (\nu + 2\delta)).$$

**Proposition 3.3.**  *$P(\lambda, \mu, \nu)$  is a polynomial function in  $\lambda, \mu$  and  $\nu$  on the interior of the regions of  $\mathcal{SA}_k$  and gives the Littlewood-Richardson coefficients there.*

The reason why Proposition 3.3 is restricted to the interior of the regions is that while polynomials for adjacent regions of the chamber complex for the Kostant partition function have to coincide on the intersection of their closures, there is a discontinuous jump in the value of the Kostant partition function



(as a piecewise polynomial function) when going from a region on the boundary of the complex to region 0 (outside the complex).

To summarize, the hyperplanes of the Steinberg arrangement are defined by the equations

$$(3.3) \quad \langle \sigma(\lambda + \delta) + \tau(\mu + \delta) - (\nu + 2\delta), \theta(\omega_j) \rangle = 0$$

or

$$(3.4) \quad \langle \sigma(\lambda) + \tau(\mu) - \nu, \theta(\omega_j) \rangle = \langle 2\delta - \sigma(\delta) - \tau(\delta), \theta(\omega_j) \rangle.$$

Note that the right hand side of (3.4) doesn't depend on  $\lambda$ ,  $\mu$  and  $\nu$ , and we will call it the  $\delta$ -shift:

$$(3.5) \quad s(\sigma, \tau, \theta, j) = \langle 2\delta - \sigma(\delta) - \tau(\delta), \theta(\omega_j) \rangle.$$

#### 4. Polynomiality in the chamber complex

We have now expressed the Littlewood-Richardson coefficients in two ways: as a quasipolynomial function over the cones of the chamber complex  $\mathcal{LR}_k$ , and as a polynomial function over the interior of the regions of the hyperplane arrangement  $\mathcal{SA}_k$ . In this section, we relate the chamber complex to the hyperplane arrangement to show that the quasipolynomials are actually polynomials.

**Theorem 4.1.** *The quasipolynomials giving the Littlewood-Richardson coefficients in the cones of the chamber complex  $\mathcal{LR}_k$  are polynomials of total degree at most  $\binom{k-1}{2}$  in the three sets of variables  $\lambda = (\lambda_1, \dots, \lambda_k)$ ,  $\mu = (\mu_1, \dots, \mu_k)$  and  $\nu = (\nu_1, \dots, \nu_k)$ .*

From this, we can deduce a “stretching” property for Littlewood-Richardson coefficients.

**Corollary 4.2.** *The Littlewood-Richardson coefficients  $c_{N\lambda N\mu}^{N\nu}$  are given by a polynomial in  $N$  with rational coefficients. This polynomial has degree at most  $\binom{k-1}{2}$  in  $N$ .*

**Remark 4.3.** King, Tollu and Toumazet conjectured in [KTT03] that the  $c_{N\lambda N\mu}^{N\nu}$  are polynomial in  $N$  with nonnegative rational coefficients (Conjecture 1.1 above). Corollary 4.2 establishes this conjecture, except for the nonnegativity of the coefficients. Derksen and Weyman [DW02] have a proof of this part of the conjecture using semi-invariants of quivers, and Knutson [DW02, Knu03] a proof using symplectic geometry techniques.

In fact, we can prove something stronger: we can perturb  $(\lambda, \mu, \nu)$  a bit and get a more global stretching property.

**Corollary 4.4.** *Let  $\Upsilon$  be the set*

$$(4.1) \quad \Upsilon = \{(\lambda, \mu, \nu) : \max\{l(\lambda), l(\mu), l(\nu)\} \leq k, |\lambda| + |\mu| = |\nu|, \lambda, \mu \subseteq \nu\}.$$

*For any generic  $(\lambda, \mu, \nu) \in \Upsilon$  we can find a neighborhood  $U$  of that point over which the function*

$$(4.2) \quad (\lambda, \mu, \nu, t) \in (U \cap \Upsilon) \times \mathbb{N} \longmapsto c_{t\lambda t\mu}^{t\nu}$$

*is polynomial of degree at most  $\binom{k-1}{2}$  in  $t$  and  $\binom{k-1}{2}$  in the  $\lambda$ ,  $\mu$  and  $\nu$  coordinates.*

**5. An example: partitions with at most 3 parts**

We want to find a vector partition function counting the number of integral 3-hives of the form

$$\begin{aligned}
 & 0 \quad \lambda_1 \quad \lambda_1 + \lambda_2 \mid \lambda \\
 & \nu_1 \quad a_{11} \quad |\lambda| + \mu_1 \\
 & \nu_1 + \nu_2 \mid \nu - \mu_3 \\
 & |\nu|
 \end{aligned}
 \tag{5.1}$$

The hives conditions are given by

$$\begin{aligned}
 & a_{11} \leq \nu_1 + \lambda_1 & -a_{11} \leq -\lambda_2 - \nu_1 & -a_{11} \leq -\lambda_1 - \nu_2 \\
 & -a_{11} \leq -\lambda_1 - \lambda_3 - \mu_1 & a_{11} \leq \lambda_1 + \lambda_2 + \mu_1 & -a_{11} \leq -\lambda_1 - \lambda_2 - \mu_2 \\
 & -a_{11} \leq -\lambda_1 - \lambda_2 - \lambda_3 - \mu_1 - \mu_2 + \nu_2 & -a_{11} \leq \mu_2 - \nu_1 - \nu_2 & a_{11} \leq \lambda_1 + \lambda_2 + \lambda_3 + \mu_1 + \mu_2 - \nu_3
 \end{aligned}
 \tag{5.2}$$

This corresponds to the matrix system

$$E_3 \cdot \begin{pmatrix} a_{11} \\ s_1 \\ s_2 \\ \vdots \\ s_9 \end{pmatrix} = B_3 \cdot \begin{pmatrix} \lambda_1 \\ \lambda_2 \\ \lambda_3 \\ \mu_1 \\ \mu_2 \\ \mu_3 \\ \nu_1 \\ \nu_2 \\ \nu_3 \end{pmatrix}
 \tag{5.3}$$

with

$$E_3 = \begin{pmatrix} 1100000000 \\ -1010000000 \\ -1001000000 \\ -1000100000 \\ 1000010000 \\ -1000001000 \\ -1000000100 \\ -1000000010 \\ 1000000001 \end{pmatrix}
 \tag{5.4}$$

and

$$B_3 = \begin{pmatrix} 1 & 0 & 0 & 0 & 0 & 0 & 1 & 0 & 0 \\ -1 & 0 & -1 & -1 & 0 & 0 & 0 & 0 & 0 \\ -1 & -1 & -1 & -1 & -1 & 0 & 0 & 1 & 0 \\ 0 & -1 & 0 & 0 & 0 & 0 & -1 & 0 & 0 \\ 1 & 1 & 0 & 1 & 0 & 0 & 0 & 0 & 0 \\ 0 & 0 & 0 & 0 & 1 & 0 & -1 & -1 & 0 \\ -1 & 0 & 0 & 0 & 0 & 0 & 0 & -1 & 0 \\ -1 & -1 & 0 & 0 & -1 & 0 & 0 & 0 & 0 \\ 1 & 1 & 1 & 1 & 1 & 0 & 0 & 0 & -1 \end{pmatrix}.
 \tag{5.5}$$

Note that  $\mu_3$  doesn't appear in this system. This is because it is determined by  $|\lambda| + |\mu| = |\nu|$ ; we could have chosen another variable to disappear.

To get the chamber complex for the vector partition function associated to  $E_3$ , we have to find the sets of columns determining maximal nonsingular square matrices in  $E_3$ . These determine the bases cones whose

common refinement gives the chamber complex. In our case, all subsets of 9 columns determine a nonsingular matrix, so we get 10 base cones. We can find their common refinement using a symbolic calculator like Maple or Mathematica; here we used Maple (version 8) and the package `convex` by Matthias Franz [Fra01]. We find the chamber complex  $\mathcal{LR}_3$  by rectifying the cones to  $(\lambda, \mu, \nu)$ -space using  $B_3^T$  and intersecting them with the cones  $C_3^{(1)}$  and  $C_3^{(2)}$ . The list of rays of the cones of  $\mathcal{LR}_3$

$$\begin{aligned}
 a_1 &= (1\ 1\ 1\ | 0\ 0\ 0\ | 1\ 1\ 1) & a_2 &= (0\ 0\ 0\ | 1\ 1\ 1\ | 1\ 1\ 1) \\
 & & b &= (2\ 1\ 0\ | 2\ 1\ 0\ | 3\ 2\ 1) \\
 & & c &= (1\ 1\ 0\ | 1\ 1\ 0\ | 2\ 1\ 1) \\
 d_1 &= (1\ 1\ 0\ | 1\ 0\ 0\ | 1\ 1\ 1) & d_2 &= (1\ 0\ 0\ | 1\ 1\ 0\ | 1\ 1\ 1) \\
 e_1 &= (1\ 1\ 0\ | 0\ 0\ 0\ | 1\ 1\ 0) & e_2 &= (0\ 0\ 0\ | 1\ 1\ 0\ | 1\ 1\ 0) \\
 & & f &= (1\ 0\ 0\ | 1\ 0\ 0\ | 1\ 1\ 0) \\
 g_1 &= (1\ 0\ 0\ | 0\ 0\ 0\ | 1\ 0\ 0) & g_2 &= (0\ 0\ 0\ | 1\ 0\ 0\ | 1\ 0\ 0)
 \end{aligned}$$

where the bars separate the entries corresponding to the sets of variables  $\lambda$ ,  $\mu$  and  $\nu$ .

The following table gives the maximal (8-dimensional) cones of  $\mathcal{LR}_3$ , as well as the polynomial associated to each (computed by polynomial interpolation).

Cone	Positive hull description	Polynomial
$\kappa_1$	$\text{pos}(a_1, a_2, b, c, d_1, d_2, e_1, e_2)$	$1 - \lambda_2 - \mu_2 + \nu_1$
$\kappa_2$	$\text{pos}(a_1, a_2, b, c, d_1, d_2, g_1, g_2)$	$1 + \nu_2 - \nu_3$
$\kappa_3$	$\text{pos}(a_1, a_2, b, c, e_1, e_2, g_1, g_2)$	$1 + \lambda_1 + \mu_1 - \nu_1$
$\kappa_4$	$\text{pos}(a_1, a_2, b, d_1, d_2, e_1, e_2, f)$	$1 + \nu_1 - \nu_2$
$\kappa_5$	$\text{pos}(a_1, a_2, b, d_1, d_2, f, g_1, g_2)$	$1 + \lambda_2 + \mu_2 - \nu_3$
$\kappa_6$	$\text{pos}(a_1, a_2, b, e_1, e_2, f, g_1, g_2)$	$1 - \lambda_3 - \mu_3 + \nu_3$
$\kappa_7$	$\text{pos}(a_1, a_2, b, c, d_1, d_2, e_1, g_1)$	$1 + \lambda_3 + \mu_1 - \nu_3$
$\kappa_8$	$\text{pos}(a_1, a_2, b, c, d_1, d_2, e_2, g_2)$	$1 + \lambda_1 + \mu_3 - \nu_3$
$\kappa_9$	$\text{pos}(a_1, a_2, b, c, d_1, e_1, e_2, g_2)$	$1 + \lambda_1 - \lambda_2$
$\kappa_{10}$	$\text{pos}(a_1, a_2, b, c, d_2, e_1, e_2, g_1)$	$1 + \mu_1 - \mu_2$
$\kappa_{11}$	$\text{pos}(a_1, a_2, b, c, d_1, e_1, g_1, g_2)$	$1 - \lambda_2 - \mu_3 + \nu_2$
$\kappa_{12}$	$\text{pos}(a_1, a_2, b, c, d_2, e_2, g_1, g_2)$	$1 - \lambda_3 - \mu_2 + \nu_2$
$\kappa_{13}$	$\text{pos}(a_1, a_2, b, d_1, d_2, e_1, f, g_1)$	$1 - \lambda_1 - \mu_3 + \nu_3$
$\kappa_{14}$	$\text{pos}(a_1, a_2, b, d_1, d_2, e_2, f, g_2)$	$1 - \lambda_3 - \mu_1 + \nu_3$
$\kappa_{15}$	$\text{pos}(a_1, a_2, b, d_1, e_1, f, g_1, g_2)$	$1 + \mu_2 - \mu_3$
$\kappa_{16}$	$\text{pos}(a_1, a_2, b, d_2, e_2, f, g_1, g_2)$	$1 + \lambda_2 - \lambda_3$
$\kappa_{17}$	$\text{pos}(a_1, a_2, b, d_1, e_1, e_2, f, g_2)$	$1 + \lambda_1 + \mu_2 - \nu_2$
$\kappa_{18}$	$\text{pos}(a_1, a_2, b, d_2, e_1, e_2, f, g_1)$	$1 + \lambda_2 + \mu_1 - \nu_2$

**Remark 5.1.** The symmetry  $c_{\lambda\mu}^\nu = c_{\mu\lambda}^\nu$  implies that we can interchange the  $\lambda$  and  $\mu$  coordinates. This corresponds to a symmetry of the chamber complex  $\mathcal{LR}_3$  under this transformation. This is why some of the rays and cones have been grouped in pairs.

**Remark 5.2.** We observe from the form of the polynomials in the table above that the equation

$$(5.6) \quad c_{N\lambda N\mu}^{N\nu} = 1 + N(c_{\lambda\mu}^\nu - 1)$$

holds for  $l(\lambda), l(\mu), l(\nu) \leq 3$ . This was previously observed in [KTT03].

### Acknowledgments

I would like to thank Sara Billey, Benoit Charbonneau, Victor Guillemin for useful discussions and comments, Ron King especially for telling me about his interesting conjectures, and also Allen Knutson and Anders Buch for bringing the results of [DW02] and [Knu03] to my attention.

## References

- [AGZ98] T. V. Alekseevskaya, I. M. Gel'fand, and A. V. Zelevinskii, *An arrangement of real hyperplanes and the partition function connected with it*, Soviet Math. Dokl. **36** (1998), no. 3, 589–593.
- [BGR03] Sara Billey, Victor Guillemin, and Etienne Rassart, *A vector partition function for the multiplicities of  $\mathfrak{sl}_k\mathbb{C}$* , To appear in the *Journal of Algebra*, arXiv:math.CO/0307227, 2003.
- [Buc00] Anders S. Buch, *The saturation conjecture (after A. Knutson and T. Tao)*, Enseign. Math. (2) **46** (2000), 43–60.
- [BZ92] A. D. Berenstein and A. V. Zelevinsky, *Triple multiplicities for  $\mathfrak{sl}(r+1)$  and the spectrum of the exterior algebra of the adjoint representation*, J. Alg. Comb. **1** (1992), 7–22.
- [DW02] Harm Derksen and Jerzy Weyman, *On the Littlewood-Richardson polynomials*, J. Algebra **255** (2002), no. 2, 247–257.
- [Ehr77] E. Ehrhart, *Polynômes arithmétiques et méthode des polyèdres en combinatoire*, International Series of Numerical Mathematics, vol. 35, Birkhäuser, 1977.
- [FH91] William Fulton and Joe Harris, *Representation theory*, GTM, vol. 129, Springer, 1991.
- [Fra01] Matthias Franz, *Convex – A Maple package for convex geometry*, Maple package, 2001, Version 0.91, Konstanz, available via internet from <http://www.mathe.uni-konstanz.de/~franz/convex/>.
- [Ful97] William Fulton, *Young tableaux*, London Mathematical Society Student Texts, vol. 35, Cambridge University Press, 1997.
- [Hum72] James E. Humphreys, *Introduction to Lie algebras and representation theory*, GTM, vol. 9, Springer, 1972.
- [Knu03] Allen Knutson, Personal communication, 2003.
- [KT99] A. Knutson and T. Tao, *The honeycomb model of  $GL_n(\mathbb{C})$  tensor products I: Proof of the saturation conjecture*, J. Amer. Math. Soc. **12** (1999), 1055–1090.
- [KTT03] R. C. King, C. Tollu, and F. Toumazet, *Stretched Littlewood-Richardson and Kostka coefficients*, To appear in CRM Proceedings and Lecture Notes, volume 34, 2003.
- [Mac95] I. G. Macdonald, *Symmetric functions and Hall polynomials, second edition*, Oxford Mathematical Monographs, Clarendon Press, Oxford Science Publications, 1995.
- [Sch86] Alexander Schrijver, *Theory of linear and integer programming*, Wiley-Interscience series in discrete mathematics, Wiley, 1986.
- [Sta99] Richard P. Stanley, *Enumerative combinatorics, volume 2*, Cambridge Studies in Advanced Mathematics, Cambridge University Press, 1999.
- [Ste61] R. Steinberg, *A general Clebsch-Gordan theorem*, Bull. Amer. Math. Soc. **67** (1961), 406–407.
- [Stu95] Bernd Sturmfels, *On vector partition functions*, Journal of Combinatorial Theory, Series A **72** (1995), 302–309.

DEPARTMENT OF MATHEMATICS, MASSACHUSETTS INSTITUTE OF TECHNOLOGY, CAMBRIDGE, USA, 02143  
*E-mail address:* rassart@math.mit.edu





## Cambrian Lattices

Nathan Reading

**Abstract.** For an arbitrary finite Coxeter group  $W$ , we define the family of Cambrian lattices for  $W$  as quotients of the weak order on  $W$  with respect to certain lattice congruences. We associate to each Cambrian lattice a complete fan, which we conjecture is the normal fan of a polytope combinatorially isomorphic to the generalized associahedron for  $W$ . In types  $A$  and  $B$ , we obtain, by means of a fiber-polytope construction, combinatorial realizations of the Cambrian lattices in terms of triangulations and in terms of permutations. Using this combinatorial information, we prove that in types  $A$  and  $B$  the Cambrian fans are combinatorially isomorphic to the normal fans of the generalized associahedra, and that one of the Cambrian fans is linearly isomorphic to Fomin and Zelevinsky's construction of the normal fan as a "cluster fan." Our construction does not require a crystallographic Coxeter group and therefore suggests a definition, at least on the level of cellular spheres, of a generalized associahedron for any finite Coxeter group. The Tamari lattice is one of the Cambrian lattices of type  $A$ , and two "Tamari" lattices in type  $B$  are identified, and characterized in terms of signed pattern avoidance. We also show that intervals in Cambrian lattices are either contractible or homotopy equivalent to spheres.

**Résumé.** Pour un groupe fini arbitraire de Coxeter  $W$ , nous définissons la famille des treillis cambriens pour  $W$  comme des quotients de l'ordre faible sur  $W$  par certaines congruences de treillis. Nous associons à chaque treillis cambrien un éventail complet et nous conjecturons que cet éventail est l'éventail normal d'un polytope isomorphe, au sens combinatoire, à un associaèdre généralisé. Dans le cas des types  $A$  et  $B$ , nous obtenons, par une construction de fibre-polytope, des réalisations combinatoires des treillis cambriens en termes de triangulations et en termes de permutations. En utilisant cette information combinatoire, nous montrons que, dans le cas des types  $A$  et  $B$ , les éventails cambriens sont isomorphes, au sens combinatoire, aux éventails normaux des associaèdre généralisés, et qu'un des éventails cambriens est linéairement isomorphe à l'éventail normal construit par Fomin et Zelevinsky sous forme de l'éventail des amas. Notre construction n'exige pas que le groupe de Coxeter soit cristallographique et suggère une définition, du moins au niveau des sphères cellulaires, d'un associaèdre généralisé pour tout groupe fini de Coxeter. Le treillis de Tamari est un des treillis cambriens du type  $A$ , et deux "treillis de Tamari" dans le type  $B$  sont identifiés, et caractérisés en termes des permutations signées à motifs exclus. Nous prouvons également que les intervalles dans les treillis cambriens sont soit contractibles, soit équivalents aux sphères, par homotopie.

---

2000 *Mathematics Subject Classification.* Primary 20F55, 06B10; Secondary 52C07.  
The author was partially supported by NSF grant DMS-0202430.

## 1. Overview

The Catalan numbers  $C_n = (1/(n+1))\binom{2n}{n}$  count a variety of combinatorial objects [18, Exercise 6.19] including triangulations of a convex  $(n+2)$ -gon. A *finite Coxeter group*  $W$  is a finite group that can be presented as a group generated by Euclidean reflections, and a *root system* associated to  $W$  is a collection of *roots*, that is, normal vectors to the reflecting hyperplanes satisfying certain conditions. The  $W$ -permutohedron is the zonotope which is the Minkowski sum of the roots. There is a  $W$ -Catalan number associated to any  $W$ , and the ordinary Catalan numbers are associated to irreducible Coxeter groups of type A (the *symmetric groups*). The *associahedron* or *Stasheff polytope* is a polytope whose vertices are counted by the Catalan numbers. Chapoton, Fomin and Zelevinsky [6, 7] have recently generalized the associahedron to all finite Coxeter groups which are *crystallographic*. Earlier, the type-B associahedron, or cyclohedron, was defined by Bott and Taubes [5] and Simion [16].

A related Catalan structure is the Tamari lattice, whose Hasse diagram is the 1-skeleton of the associahedron. Simion [16, §5] asked if the vertices of the type-B associahedron could be partially ordered so as to obtain a lattice whose Hasse diagram is the 1-skeleton of the type-B associahedron. Reiner [15, Remark 5.4] used an equivariant fiber polytope construction to identify a family of maps from the type-B permutohedron to the type-B associahedron, in analogy to well-known maps in type A. He asked whether one of these maps can be used to define a partial order on the vertices of the type-B associahedron with similar properties to the Tamari lattice, such that the map from the type-B permutohedron to the type-B associahedron shared the pleasant properties of the corresponding map in type A (see [4, §9]).

The (right) weak order is a partial order on a Coxeter group  $W$ , and is a lattice when  $W$  is finite [3]. On the symmetric group of permutations, one moves up in the weak order by switching two adjacent entries so as to put them out of order. The starting point of the present research is the observation that the Tamari lattice is a lattice-homomorphic image of the weak order on the symmetric group. This fact has, to our knowledge, never appeared in the literature, although essentially all the ingredients of a proof were assembled by Björner and Wachs in [4]. This lattice-theoretic point of view suggests a search among Reiner's maps to determine which induces a lattice homomorphism on the weak order. Surprisingly, for each of these maps, one can choose a vertex of the type-B permutohedron to label as the identity element so that the map induces a lattice homomorphism. Thus each of Reiner's maps defines a lattice structure on the type-B associahedron. Furthermore, the analogous family of maps in type A yields a family of lattices on vertices of the type-A associahedron. A close look at the lattice homomorphisms in types A and B leads to a type-free generalization of these families of lattices which we call *Cambrian lattices*. The name "Cambrian" can be justified by a geological analogy: The Cambrian layer of rocks marks a dramatic increase in the diversity of the fossil record and thus the sudden profusion of Catalan-related lattices arising from the single (Pre-Cambrian) example of the Tamari lattice might fittingly be called *Cambrian*.

A *congruence* on a lattice  $L$  is an equivalence relation on  $L$  which respects the operations of meet and join in the same way that, for example, a congruence on the integers respects addition and multiplication. The congruences on a finite lattice  $L$  are in particular partitions, so we can partially order the set of congruences of  $L$  by refinement. This partial order is known to be a distributive lattice [8]. In particular, it is a lattice, so one can specify a set of equivalences, and ask for the smallest congruence containing those equivalences.

A finite Coxeter group has a diagram  $G$ , a graph whose vertices are a certain set of generating reflections, with edges labeled by pairwise orders  $m(s, t)$  of the generators. The pairwise order  $m(s, t)$  is the smallest integer such that  $(st)^{m(s, t)} = 1$ . If  $m(s, t)$  is 2 then there is no edge in  $G$  connecting  $s$  and  $t$ . An *orientation*  $\vec{G}$  of  $G$  is a directed graph with the same vertex set as  $G$ , with one directed edge for each edge of  $G$ . Thus if  $G$  has  $e$  edges, there are  $2^e$  orientations of  $G$ . For each orientation  $\vec{G}$  of  $G$ , there is a Cambrian lattice, defined as follows. For a directed edge  $s\vec{\Omega}t$  in  $\vec{G}$ , require that  $t$  be equivalent to the element of  $W$  represented by the word  $tsts\cdots$  with  $m(s, t) - 1$  letters. The *Cambrian congruence* associated to  $\vec{G}$  is the smallest congruence of the (right) weak order on  $W$  satisfying this requirement for each directed edge in  $\vec{G}$ . The Cambrian lattice



$\mathcal{C}(\vec{G})$  is defined to be the (right) weak order on  $W$  modulo the Cambrian congruence associated to  $\vec{G}$ . Two Cambrian lattices are isomorphic (respectively anti-isomorphic) exactly when the associated diagrams are isomorphic (respectively anti-isomorphic), taking edge labelings into account.

For any finite Coxeter group  $W$ , let  $\mathcal{F}$  be the fan defined by the reflecting hyperplanes of  $W$ . One can identify the maximal cones of  $\mathcal{F}$  with the elements of  $W$ . In [12] a fan  $\mathcal{F}_\Theta$  is defined for any lattice congruence  $\Theta$  of the weak order on  $W$ , such that the maximal cones of  $\mathcal{F}_\Theta$  are the unions over congruence classes of the maximal cones of  $\mathcal{F}$ . The lattice quotient  $W/\Theta$  is a lattice whose elements are the maximal cones of  $\mathcal{F}_\Theta$ . Let  $\mathcal{F}(\vec{G})$  be the *Cambrian fan* constructed in this way from the Cambrian congruence associated to  $\vec{G}$ .

**Conjecture 1.1.** *For any finite Coxeter group  $W$  and any orientation  $\vec{G}$  of the associated Coxeter diagram, the fan  $\mathcal{F}(\vec{G})$  associated to the Cambrian lattice  $\mathcal{C}(\vec{G})$  is the normal fan of a convex polytope which is combinatorially isomorphic to the generalized associahedron for  $W$ .*

Each statement in the following conjecture is would be implied by Conjecture 1.1, and proofs of any of these weaker conjectures would be interesting. Statements b.–e. are weakenings of a.

**Conjecture 1.2.** *For any Coxeter group  $W$  with digram  $G$ :*

- a. *Given any orientation  $\vec{G}$  of  $G$ , the fan  $\mathcal{F}(\vec{G})$  is combinatorially isomorphic to the normal fan of the generalized associahedron for  $W$ .*
- b. *Given any orientation  $\vec{G}$  of  $G$ , the fan  $\mathcal{F}(\vec{G})$  is combinatorially isomorphic to the normal fan of some polytope.*
- c. *All Cambrian fans arising from different orientations of  $G$  are combinatorially isomorphic.*
- d. *All Cambrian fans arising from different orientations of  $G$  have the same number of maximal cones.*
- e.  *$\mathcal{F}(\vec{G})$  is simplicial for any orientation  $\vec{G}$  of  $G$ .*

The fan  $\mathcal{F}_\Theta$  is PL for any  $\Theta$ , so that in particular  $\mathcal{F}(\vec{G})$  has a dual cellular sphere  $\Gamma(\vec{G})$ . If Conjecture 1.1 holds, then in particular,  $\Gamma(\vec{G})$  is a polytope, and the Cambrian fans offer an alternate definition of the generalized associahedra. In the absence of a proof of Conjecture 1.1, we will nonetheless refer to the dual spheres  $\Gamma(\vec{G})$  as generalized associahedra. This construction lifts the restriction to crystallographic Coxeter groups imposed by the definition in [7], giving the first definition of associahedra of types H and I. The associahedra for  $H_3$  and  $I_2(m)$  constructed from Cambrian lattices have the numbers of faces of each dimension one would expect from generalized associahedra, and the facets of the  $H_3$  associahedron are the correct generalized associahedra of lower dimension. The  $I_2(m)$ -associahedron is an  $(m + 2)$ -gon and the 1-skeleton of the  $H_3$ -associahedron is pictured in Figure 1.

The Cambrian lattices and fans have the following properties which follow from the results of [12]. First,  $\mathcal{C}(\vec{G})$  is a partial order induced on the maximal cones of  $\mathcal{F}(\vec{G})$  by a linear functional, and the Hasse diagram of  $\mathcal{C}(\vec{G})$  is isomorphic to the 1-skeleton of the dual sphere  $\Gamma(\vec{G})$ . The set of cones containing a given face  $F$  of  $\mathcal{F}(\vec{G})$  is an interval in  $\mathcal{C}(\vec{G})$  called a *facial interval*. Non-facial intervals in  $\mathcal{C}(\vec{G})$  are contractible and facial intervals are homotopy-equivalent to spheres with the dimension of the sphere depending on the dimension of the corresponding face of  $\mathcal{F}(\vec{G})$ . If  $\mathcal{F}(\vec{G})$  is indeed simplicial, the corresponding simplicial sphere is flag and any linear extension of  $\mathcal{C}(\vec{G})$  is a shelling of the corresponding simplicial sphere. If  $\mathcal{F}(\vec{G})$  is indeed polytopal, then since it refines the normal fan of  $\mathcal{F}$ , the associated polytope in a Minkowski summand of the  $W$ -permutohedron.

Because disconnected Coxeter diagrams lead to direct product decompositions of all of the relevant objects, it is enough to prove Conjecture 1.1 in the case of connected Coxeter diagrams, or equivalently irreducible Coxeter groups. We use (equivariant) fiber polytope constructions to work out the combinatorics of Cambrian lattices of types A and B in detail, both in terms of triangulations and in terms of permutations. In particular, we prove that:

**Theorem 1.3.** *Conjecture 1.2.a holds when  $W$  is of type A or B.*

FIGURE 1. The 1-skeleton of the  $H_3$ -associahedron. The vertex at infinity completes the three unbounded regions to heptagons.

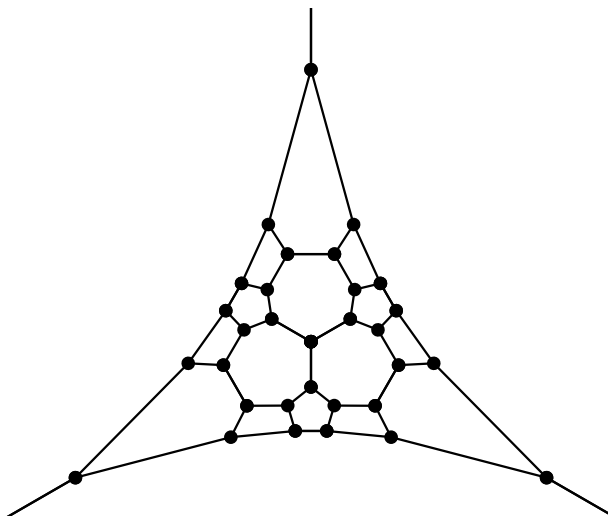

Fomin's and Zelevinsky's definition [7] of generalized associahedra is in terms of *clusters* of roots in the root system  $\Phi$  associated to  $W$ . For the purposes of this extended abstract, it suffices to say the following about clusters. One begins with a bipartition  $G = I_+ \cup I_-$  of the Coxeter diagram for  $W$ , and uses the bipartition to construct piecewise linear maps  $\tau_+$  and  $\tau_-$  acting on the root space of  $\Phi$ , and generating a dihedral group of piecewise linear maps. These two maps are used to define the *clusters*, certain subsets of  $\Phi$  whose cardinality is the rank of  $W$ . The *cluster fan* is the fan whose maximal cones are the cones generated by the clusters, and the  $W$ -associahedron is defined as the polytope whose normal fan is the cluster fan. In particular, the clusters index the vertices of the generalized associahedron for  $W$ , and the edges are pairs of clusters which differ by exchanging one root. Using  $\tau_+$  and  $\tau_-$  to compare the roots that are exchanged along an edge, we define a partial order on the clusters called the *cluster poset*.

Naturally associated to the bipartition  $G = I_+ \cup I_-$  is an orientation of  $G$  which we denote  $I_+ \longrightarrow I_-$ , and call a *bipartite orientation*. Specifically, any edge in  $G$  connects an element  $s$  of  $I_+$  to an element  $t$  of  $I_-$ , and we direct the edge  $s\tilde{\Omega}t$ .

**Conjecture 1.4.** *The Cambrian fan for the orientation  $I_+ \longrightarrow I_-$  is linearly isomorphic to the cluster fan, and the Cambrian lattice for the same orientation is the cluster poset.*

This conjecture would in particular imply that the cluster poset is a lattice, that it is induced on the vertices of the generalized associahedron by a linear functional, that its Hasse diagram is isomorphic to the 1-skeleton of the generalized associahedron, and that it has the pleasant homotopy and shelling properties described above. General proofs of any of these weaker statements would also be interesting.

Conjecture 1.4 can be proven in types A and B. This provides a proof of Conjecture 1.1 in the special case where  $\vec{G}$  is a bipartite orientation of the diagram of a Coxeter group of type A or B. As further support for Conjecture 1.4, we prove the following fact which would be a consequence of Conjecture 1.4.

**Theorem 1.5.** *The cluster fan refines a fan that is linearly isomorphic to the normal fan of the  $W$ -permutohedron.*

In light of the combinatorial description of Cambrian lattices of type A which will be given in Section 2, the Tamari lattice is the type-A Cambrian lattice associated to a path directed linearly, that is, with the arrows all pointing the same direction. Call this the *Tamari orientation* of the diagram. By the symmetry

of the path and the fact that directed diagram anti-automorphisms induce lattice anti-automorphisms, we recover the fact that the Tamari lattice is self-dual. The Coxeter diagram for type B is a path as well, but has an asymmetric edge-labeling. There are two Tamari orientations, linear orientations of the type B diagram, yielding two “Type-B Tamari lattices,” which are not isomorphic but dual to each other. In support of their claim to the title of “Tamari” is the fact that they can be constructed as the restriction of the weak order to signed permutations avoiding certain signed patterns (Proposition 2.6). The type-A Tamari lattice has a well-known realization in terms of pattern-avoidance. Because the type-B Tamari elements are counted by the type-B Catalan numbers, this result has some bearing on a question posed by Simion in the introduction to [17], which asked for signed permutation analogues of counting formulas for restricted permutations. Thomas [20], working independently and roughly simultaneously, used one of Reiner’s maps to construct the type-B Tamari lattice and proposed a type-D Tamari lattice.

Stasheff and Schnider [19] gave a realization of the type-A associahedron by specifying facet hyperplanes, and Loday [11] determined the vertices of this realization. The Cambrian fan for the type-A Tamari orientation is the normal fan of this realization of the associahedron, thus proving Conjecture 1.1 for the Tamari orientation in type A. Thus in type A, the Cambrian fans interpolate between the cluster fan and the normal fan of Stasheff’s and Schnider’s realization of the associahedron.

In general, the quotient of a lattice  $L$  with respect to some congruence is isomorphic to an induced subposet of  $L$ , but need not be a sublattice. However, in types A and B, the Cambrian lattices are sublattices of the weak order. This fact was proven for the Tamari lattices in [4].

**Conjecture 1.6.** *For any finite Coxeter group  $W$  and any orientation  $\vec{G}$  of the associated Coxeter diagram, the Cambrian lattice  $\mathcal{C}(\vec{G})$  is a sublattice of the weak order on  $W$ .*

The Cambrian lattices also inherit any lattice property from the weak order which is preserved by homomorphisms. Notably, the Cambrian lattices are *congruence uniform*, generalizing a theorem of Geyer [9] on the Tamari lattice.

For a finite Coxeter group  $W$ , let the (left) descent map  $\text{des} : W\tilde{\Omega}2^S$  be the map which associates to each  $w \in W$  its (left) descent set. This map is a lattice homomorphism from the (right) weak order on  $W$  onto a boolean algebra [10] (see also [13]). The homomorphism  $\eta$  from the weak order to a Cambrian lattice factors through the map  $\text{des}$  in the sense that there is a lattice homomorphism also called  $\text{des}$  from the Cambrian lattice to  $2^S$  such that  $\text{des} \circ \eta = \text{des} : W\tilde{\Omega}2^S$ . In types A and B we identify this map on triangulations.

## 2. Combinatorics of Cambrian lattices of type A

Space does not permit us to elaborate on every assertion made in the overview. We will conclude this extended abstract by describing combinatorial realizations of the Cambrian lattices of type A which arise naturally from a fiber polytope construction, and adding a few words about type B. For background information on these fiber polytope constructions, see [1, 2, 15].

Consider a tower of surjective linear maps of polytopes

$$\Delta^{n+1} \xrightarrow{\sigma} Q_{n+2} \xrightarrow{\rho} I,$$

where  $I$  is a 1-dimensional polytope,  $Q_{n+2}$  is a polygon with  $n + 2$  vertices, and  $\Delta^{n+1}$  is the  $(n + 1)$ -dimensional simplex whose vertices are the coordinate vectors  $e_0, e_1, \dots, e_{n+1}$  in  $\mathbb{R}^{n+2}$ . When  $n$  has already been specified, we will sometimes refer to these polytopes simply as  $\Delta$  and  $Q$ . Let  $a_i := \rho(\sigma(e_i))$  and  $v_i := \sigma(e_i)$ , and suppose that  $a_0 < a_1 < \dots < a_{n+1}$ . Let  $f$  be a non-trivial linear functional on  $\ker \rho$ . We may as well take  $\rho$  to be an orthogonal projection of  $Q$  onto the line segment whose endpoints are  $v_0$  and  $v_{n+1}$  and think of  $f$  as giving the positive or negative “height” of each vertex of  $Q_{n+2}$  above that line segment. We abbreviate  $f_i := f(\sigma(e_i))$  and use the shorthand  $\bar{i}$  to denote an  $i \in [n]$  with  $f_i \geq 0$ . In this case we will call  $v_i$  an *up vertex* and  $i$  an *up index*. Similarly,  $\underline{i}$  will denote an  $i \in [n]$  with  $f_i \leq 0$ , called a

down index. Thus for example the phrase “Let  $\underline{i} \in [n]$ ” means “Let  $i \in [n]$  have  $f_i \leq 0$ .” For any  $H \subseteq [n]$ , let  $\underline{H} = \{\underline{i} \in H\}$  and let  $\overline{H} = \{\overline{i} \in H\}$ .

The fiber polytope  $\Sigma(\Delta \xrightarrow{\rho \circ \sigma} I)$  is a cube whose vertices correspond to triangulations of the point configuration  $\{a_0, a_1, \dots, a_{n+1}\}$ . Such a triangulation can be thought of as a subset  $H$  of  $[n]$  where  $H$  is the set of points (other than the endpoints of  $I$ ) appearing as vertices of the triangulation. We will write  $H = \{i_1, i_2, \dots, i_k\} \subseteq [n]$ , with  $0 = i_0 < i_1 < i_2 < \dots < i_k < i_{k+1} = n + 1$ .

The iterated fiber polytope  $\Sigma(\Delta \tilde{\Omega} Q \tilde{\Omega} I)$  is the  $f$ -monotone path polytope of  $\Sigma(\Delta \xrightarrow{\rho \circ \sigma} I)$ . (In this case it is known [2] that every  $f$ -monotone path is coherent.) The  $f$ -monotone paths are permutations, and  $\Sigma(\Delta \tilde{\Omega} Q \tilde{\Omega} I)$  is combinatorially isomorphic to the  $(A_{n-1})$ -permutohedron [2]. Specifically, an  $f$ -monotone path  $\underline{[n]} = H_0 \tilde{\Omega} H_1 \tilde{\Omega} \dots \tilde{\Omega} H_n = \overline{[n]}$  is associated to the permutation  $x_1 x_2 \dots x_n$  where  $a_{x_i}$  is the unique element in the symmetric difference of  $H_i$  and  $H_{i-1}$ . Two such monotone paths are connected by an edge in  $\Sigma(\Delta \tilde{\Omega} Q \tilde{\Omega} I)$  if they differ in only one vertex. Thus edges correspond to cover relations in the (right) weak order.

The fiber polytope  $\Sigma(\Delta^{n+1} \xrightarrow{\sigma} Q_{n+2})$  is combinatorially isomorphic [1] to the  $(A_{n-1})$ -associahedron, whose vertices are the triangulations of  $Q$ . By a general theorem in [2], the normal fan of  $\Sigma(\Delta \tilde{\Omega} Q \tilde{\Omega} I)$  refines that of  $\Sigma(\Delta \tilde{\Omega} Q)$ . In other words there is a map  $\eta : \Sigma(\Delta \tilde{\Omega} Q \tilde{\Omega} I) \rightarrow \Sigma(\Delta \tilde{\Omega} Q)$  respecting the facial structure.

We are most interested in the restriction of  $\eta$  to the vertices of the permutohedron (i.e. to permutations), so from now on  $\eta$  will refer to that restriction. The map  $\eta$  takes a permutation  $x = x_1 x_2 \dots x_n$  to a triangulation of  $Q$ , and has a characterization in terms of polygonal paths [2]. The edges of the triangulation arise as a union of polygonal paths  $\gamma_0, \gamma_1, \dots, \gamma_n$  in  $Q$  such that each vertex of each path is a vertex of  $Q$ , and such that each path visits vertices in the order given by their subscripts. Specifically, if  $x$  is the permutation associated to the monotone path  $H_0 \tilde{\Omega} H_1 \tilde{\Omega} \dots \tilde{\Omega} H_n$ , then  $\gamma_i(x)$  visits the vertices  $\{v_j : j \in H_i\}$  in the order given by their subscripts. Alternately, let  $\gamma_0(x)$  be the path from  $v_0$  to  $v_{n+1}$  passing through the points  $v_i$  for  $\underline{i} \in [n]$  and define  $\gamma_i$  recursively: If  $x_i$  is  $\underline{x}_i$ , define  $\gamma_i$  by deleting  $v_{x_i}$  from the list of vertices visited by  $\gamma_{i-1}$ . If  $x_i$  is  $\overline{x}_i$ , define  $\gamma_i$  by adding  $v_{x_i}$  to the list of vertices visited by  $\gamma_{i-1}$ . The union of the paths  $\gamma_0, \gamma_1, \dots, \gamma_n$  is the union of the edges in the triangulation  $\eta(x)$ .

The combinatorics of the map  $\eta$  from permutations to triangulations of  $Q$  derive from the sign of  $f$  on each vertex of  $Q$ . Thus to be more exact, we should name the map  $\eta_f$ . Usually, however, the choice of  $f$  will be fixed, so we will drop the subscript  $f$  and pick it up again when we want to emphasize the fact that  $f$  can vary.

**Theorem 2.1.** *The fibers of  $\eta$  are the congruence classes of a lattice congruence  $\Theta$  on the weak order on permutations.*

Congruence classes of a congruence on a finite lattice  $L$  are all intervals, and the quotient of  $L$  mod the congruence is isomorphic to the subposet induced on the set of bottom elements of congruence classes. Thus, by identifying the set of triangulations of  $Q$  with the set of permutations which are the bottom of their congruence class, we induce a partial order on the triangulations. The content of Theorem 2.1 is that  $\eta$  is a lattice homomorphism from the weak order onto this partial order. We call the associated congruence  $\Theta_f$ .

Orientations  $\vec{G}$  of the Coxeter diagram for  $A_{n-1}$  correspond to choices of the linear functional  $f$  as follows. Given  $f$ , define the orientation  $\vec{G}_f$  to be  $s_{\overline{b}} \tilde{\Omega} s_{b-1}$  for every  $\overline{b} \in [2, n - 1]$  and  $s_{b-1} \tilde{\Omega} s_b$  for every  $\underline{b} \in [2, n - 1]$ . By the reverse process, an orientation  $\vec{G}$  specifies which indices in  $[2, n - 1]$  are up or down, and the indices 1 and  $n$  can be arbitrarily chosen as up or down indices. Denote any polygon corresponding to such a choice of up and down vertices as  $Q(\vec{G})$ .

In [13], the author determined the congruence lattice of the weak order on  $S_n$ . Knowing the congruence lattice allows us to prove the following:

**Theorem 2.2.** *The quotient lattice  $S_n / \Theta_f$  is the Cambrian lattice  $\mathcal{C}(\vec{G}_f)$ .*

Say that  $x$  contains the pattern  $\overline{231}$  if there exist  $1 \leq i < j < k \leq n$  with  $x_k < \overline{x_i} < x_j$ . Recall that this means  $x_k < x_i < x_j$  and  $f_{x_i} > 0$ . No conditions are placed on  $f_{x_j}$  or  $f_{x_k}$ . Similarly,  $x$  contains the pattern  $31\overline{2}$  if there exist  $1 \leq i < j < k \leq n$  with  $x_j < \underline{x_k} < x_i$ . If a permutation does not contain a given pattern, we say it avoids that pattern.

**Theorem 2.3.** *For  $\vec{G}$  an orientation of the Coxeter diagram for  $A_{n-1}$ , the Cambrian lattice  $\mathcal{C}(\vec{G})$  is isomorphic to the subposet of the (right) weak order on  $S_n$  consisting of permutations avoiding both  $\overline{231}$  and  $31\overline{2}$ , where up and down indices are determined by the vertices of  $Q(\vec{G})$ .*

The edges of the  $(A_{n-1})$ -associahedron correspond to diagonal flips. The slope of a diagonal will refer to the usual slope, relative to the convention that the positive horizontal direction is the direction of a ray from  $v_0$  through  $v_{n+1}$  and the positive vertical direction is the positive direction of the functional  $f$ .

**Theorem 2.4.** *For  $\vec{G}$  an orientation of the Coxeter diagram for  $A_{n-1}$ , the Cambrian lattice  $\mathcal{C}(\vec{G})$  is isomorphic to the partial order on triangulations of an  $(n + 2)$ -gon  $Q(\vec{G})$  whose cover relations are diagonal flips, where going up in the cover relation corresponds to increasing the slope of the diagonal.*

Also as a consequence of Theorem 2.2, we can prove the type-A case of Theorem 1.3. Finally, we have the following theorem.

**Theorem 2.5.** *For any orientation  $\vec{G}$  of the Coxeter diagram associated to  $A_{n-1}$ , the Cambrian lattice  $\mathcal{C}(\vec{G})$  is a sublattice of the weak order on  $A_{n-1}$ .*

An equivariant fiber-polytope construction produces combinatorial realizations which are related to the type-A case by the standard “folding” construction. These folded lattices can be realized combinatorially by centrally symmetric triangulations of a centrally symmetric polygon, or by restricted signed permutations. However, the fact that these are combinatorial realizations of the Cambrian lattices does not follow from the type-A proof by folding, but must be argued separately, using the characterization of the congruence lattice of the weak order on  $B_n$  from [13].

When  $\vec{G}$  is the diagram for a Coxeter group of type B, directed linearly from one endpoint to the other, we call  $\mathcal{C}(\vec{G})$  a type-B Tamari lattice. The justification for the name comes from the fact that, in analogy to type A, these are the unique Cambrian lattices of type B which can be defined via signed pattern avoidance, without reference to up indices and down indices.

To any sequence  $(a_1, a_2, \dots, a_p)$  of distinct nonzero integers, we associate a *standard signed permutation*  $\text{st}(a_1, a_2, \dots, a_p)$ . This is the signed permutation  $\pi \in B_p$  such that  $\pi_i < 0$  if and only if  $a_i < 0$  and  $|\pi_i| < |\pi_j|$  if and only if  $|a_i| < |a_j|$ . So for example  $\text{st}(7-3-51) = 4-2-31$ . Rephrasing [17], we say that a signed permutation  $\pi$  *contains* a signed permutation  $\tau$  if there is a subsequence of the entries of  $\pi$  whose standard signed permutation is  $\tau$ . Otherwise, say that  $\pi$  *avoids*  $\tau$ .

**Proposition 2.6.** *One of the type-B Tamari lattices is the sublattice of the weak order on signed permutations consisting of signed permutations avoiding the signed patterns  $-2-1$ ,  $2-1$ ,  $-231$ ,  $-12-3$ ,  $12-3$  and  $231$ . The other is the sublattice consisting of signed permutations avoiding  $-21$ ,  $1-2$ ,  $-2-1-3$ ,  $-13-2$ ,  $3-12$  and  $312$ .*

### 3. Acknowledgements

The author wishes to thank Sergey Fomin, Vic Reiner, John Stembridge and Hugh Thomas for helpful conversations.

### References

- [1] L. Billera and B. Sturmfels, *Fiber polytopes*, Ann. of Math. (2) **135** (1992) no. 3, 527–549.
- [2] L. Billera and B. Sturmfels, *Iterated Fiber polytopes*, Mathematika **41** (1994) no. 2, 348–363.
- [3] A. Björner, *Orderings of Coxeter groups*, Combinatorics and algebra (Boulder, Colo., 1983), 175–195, Contemp. Math. **34**.
- [4] A. Björner and M. Wachs, *Shellable nonpure complexes and posets. II*, Trans. Amer. Math. Soc. **349** (1997), no. 10, 3945–3975.
- [5] R. Bott and C. Taubes, *On the self-linking of knots*, Topology and physics. J. Math. Phys. **35** (1994) no. 10, 5247–5287.

- [6] F. Chapoton, S. Fomin and A. Zelevinsky, *Polytopal realizations of generalized associahedra*, *Canad. Math. Bull.* **45** (2002) no. 4, 537–566.
- [7] S. Fomin and A. Zelevinsky, *Y-systems and generalized associahedra*, *Ann. of Math.*, to appear.
- [8] N. Funayama and T. Nakayama, *On the distributivity of a lattice of lattice-congruences*, *Proc. Imp. Acad. Tokyo* **18** (1942), 553–554.
- [9] W. Geyer, *On Tamari lattices*, *Discrete Math.* **133** (1994) no. 1-3, 99–122.
- [10] C. Le Conte de Poly-Barbut, *Sur les Treillis de Coxeter Finis* (French), *Math. Inf. Sci. hum.* **32** no. 125 (1994), 41–57.
- [11] J.-L. Loday, *Realization of the Stasheff polytope*, preprint, 2002.
- [12] N. Reading *Fans and algebras arising from lattice congruences of the weak order*, preprint, 2003.
- [13] N. Reading, *Lattice congruences of the weak order*, preprint, 2003.
- [14] N. Reading, *Order Dimension, Strong Bruhat Order and Lattice Properties for Posets*, *Order* **19** (2002) no. 1, 73–100.
- [15] V. Reiner, *Equivariant fiber polytopes*, *Doc. Math.* **7** (2002) 113–132 (electronic).
- [16] R. Simion, *A type-B associahedron*, *Formal power series and algebraic combinatorics* (Scottsdale, AZ, 2001). *Adv. in Appl. Math.* **30** (2003) no. 1-2, 2–25.
- [17] R. Simion, *Combinatorial statistics on type-B analogues of noncrossing partitions and restricted permutations*, *Electron. J. Combin.* **7** (2000) no. 1, Research Paper 9, 27 pp.
- [18] R. Stanley, *Enumerative combinatorics. Vol. 2*, *Cambridge Studies in Advanced Mathematics*, 62. Cambridge University Press, Cambridge, 1999.
- [19] J. Stasheff, *From operads to “physically” inspired theories*, *Operads: Proceedings of Renaissance Conferences* (Hartford, CT/Luminy, 1995), 53–81, *Contemp. Math.* **202**, Amer. Math. Soc., Providence, RI, 1997.
- [20] H. Thomas, *Tamari Lattices for types B and D*, preprint, 2003.

MATHEMATICS DEPARTMENT, UNIVERSITY OF MICHIGAN, ANN ARBOR, MI 48109-1109, USA

*E-mail address:* nreading@umich.edu



## On a Class of Totally Nonnegative $f$ -immanants

Brendon Rhoades and Mark Skandera

**Abstract.** We define a family of totally nonnegative polynomials of the form  $\sum f(\sigma)x_{1,\sigma(1)} \cdots x_{n,\sigma(n)}$  and show that this family generalizes all known totally nonnegative polynomials of the form  $\Delta_{J,J'}(x)\Delta_{L,L'}(x) - \Delta_{I,I'}(x)\Delta_{K,K'}(x)$ , where  $\Delta_{J,J'}(x), \dots, \Delta_{K,K'}(x)$  are matrix minors. We also give new conditions on the sets  $J, \dots, K'$  which guarantee that the corresponding polynomials are totally nonnegative.

**RÉSUMÉ.** Nous donnons une famille de polynômes totalement nonnegatifs de la forme  $\sum f(\sigma)x_{1,\sigma(1)} \cdots x_{n,\sigma(n)}$  et montrons que cette famille generalise tous les polynômes totalement nonnegatifs de la forme  $\Delta_{J,J'}(x)\Delta_{L,L'}(x) - \Delta_{I,I'}(x)\Delta_{K,K'}(x)$ , ou  $\Delta_{J,J'}(x), \dots, \Delta_{K,K'}(x)$  sont des mineurs des matrices. Nous donnons aussi des conditions nouvelles sur les ensembles  $J, \dots, K'$  qui garantissent que les polynômes correspondents sont totalement nonnegatifs.

### 1. Introduction

A real matrix is called *totally nonnegative* (TNN) if the determinant of each of its square submatrices is nonnegative. Such matrices appear in many areas of mathematics and the concept of total nonnegativity has been generalized to apply not only to matrices, but also to other mathematical objects (See e.g. [10] and references there.) In particular, a polynomial  $p(x)$  in  $n^2$  variables  $x = (x_{1,1}, \dots, x_{n,n})$  is called *totally nonnegative* if it satisfies

$$p(A) \stackrel{\text{def}}{=} p(a_{1,1}, \dots, a_{n,n}) \geq 0$$

for every  $n \times n$  TNN matrix  $A = [a_{i,j}]$ . Obvious examples are the  $n \times n$  determinant and the  $k \times k$  minors, i.e. the determinants of  $k \times k$  submatrices. Given subsets  $I = \{i_1, \dots, i_k\}$  and  $I' = \{i'_1, \dots, i'_k\}$  of  $[n] = \{1, \dots, n\}$  we define the  $(I, I')$  minor to be the polynomial

$$\Delta_{I,I'}(x) = \sum_{\sigma \in S_k} (-1)^{\text{INV}(\sigma)} x_{i_1, i'_{\sigma(1)}} \cdots x_{i_k, i'_{\sigma(k)}}.$$

Thus  $\Delta_{I,I'}(A)$  is the determinant of the submatrix of  $A$  corresponding to rows  $I$  and columns  $I'$ .

Some recent interest in TNN polynomials concerns a collection of polynomials arising in the study of canonical bases of quantum groups [3]. While this collection, known as the *dual canonical basis* of type  $A_{n-1}$ , currently has no simple description, Lusztig [18] has proved that it consists entirely of TNN polynomials. Berenstein, Gelfand, and Zelevinsky [4, 11] have developed machinery to enumerate the dual canonical basis elements for small  $n$ , and further investigation suggests that these polynomials are expressible as subtraction-free Laurent expressions in matrix minors [9].

---

1991 *Mathematics Subject Classification.* 15A15.

*Key words and phrases.* total nonnegativity, Temperley-Lieb algebras.

Progress on the problem of describing the dual canonical basis is obstructed somewhat by the scarcity of nontrivial families of polynomials which are known to be TNN. Providing examples of such families, several authors have conjectured and proved the total nonnegativity of polynomials called  $f$ -*immanants*, constructed from functions  $f : S_n \rightarrow \mathbb{R}$  by

$$(1.1) \quad \text{Imm}_f(x) = \sum_{\sigma \in S_n} f(\sigma)x_{1,\sigma(1)} \cdots x_{n,\sigma(n)}.$$

Stembridge proved the total nonnegativity of the immanants  $\text{Imm}_{\chi^\lambda}(x)$  constructed from the irreducible characters  $\chi^\lambda : S_n \rightarrow \mathbb{R}$  of  $S_n$  [20, Cor. 3.3]. (See also [15].) These immanants are usually abbreviated  $\text{Imm}_\lambda(x)$ ,

$$(1.2) \quad \text{Imm}_\lambda(x) = \sum_{\sigma \in S_n} \chi^\lambda(\sigma)x_{1,\sigma(1)} \cdots x_{n,\sigma(n)}.$$

Stembridge also proved the stronger result [20, Cor. 3.4] that the immanants

$$(1.3) \quad \text{Imm}_\lambda(x) - \deg(\chi^\lambda) \det(x)$$

are TNN, where  $\deg(\chi^\lambda)$  is the dimension of the Specht module  $\mathcal{S}^\lambda$ , i.e. the number of standard Young tableaux of shape  $\lambda$ .

Discovering another family of TNN immanants, Fallat et. al. [8, Thm. 4.6] characterized all TNN immanants of the form

$$(1.4) \quad \Delta_{J,J}(x)\Delta_{\bar{J},\bar{J}}(x) - \Delta_{I,I}(x)\Delta_{\bar{I},\bar{I}}(x),$$

where  $\bar{I} = [n] \setminus I$ ,  $\bar{J} = [n] \setminus J$ . This result was later strengthened [19, Thm. 3.2] to include products of nonprincipal minors

$$(1.5) \quad \Delta_{J,J'}(x)\Delta_{\bar{J},\bar{J}'}(x) - \Delta_{I,I'}(x)\Delta_{\bar{I},\bar{I}'}(x).$$

(For other work concerning TNN immanants, see [2, 7].)

More results of Stembridge [20, Sec. 2], [21, Sec. 5] suggest that certain quotients of the symmetric group algebra provide important information about TNN polynomials in general. In this paper, we use such a quotient which is isomorphic to the Temperley-Lieb algebra  $\mathfrak{t}^n$  to define a family of functions

$$\{f_\tau : S_n \rightarrow \mathbb{R} \mid \tau \text{ a basis element of } \mathfrak{t}^n\}$$

and a family of corresponding TNN immanants  $\{\text{Imm}_{f_\tau}\}$  whose cone contains all immanants in the family (1.5). We begin in Section 2 with some of the well-known combinatorics of total nonnegativity. Then in Section 3 we introduce the Temperley-Lieb algebra and derive our main results. Finally in Section 4 we give an improved criterion for deciding whether or not an immanant of the form (1.5) is TNN.

## 2. Total nonnegativity and planar networks

It is possible to prove that some polynomials  $p(x)$  are TNN by providing a combinatorial interpretation for  $p(A)$  whenever  $A$  is a TNN matrix. Typically such a combinatorial interpretation involves a particular class of digraphs which we will call planar networks.

We define a *planar network of order  $n$*  to be an acyclic planar directed multigraph  $G = (V, E)$  in which  $2n$  boundary vertices are labeled counterclockwise as  $q_1, \dots, q_n, q'_n, \dots, q'_1$ . The vertices  $q_1, \dots, q_n$  are called *sources* and the vertices  $q'_1, \dots, q'_n$  are called *sinks*. Each edge  $e \in E$  is weighted by a positive real weight  $\omega(e)$ , and we will define the weight of a set  $F$  of edges to be the product of weights of edges in  $F$ ,

$$(2.1) \quad \omega(F) = \prod_{e \in F} \omega(e).$$



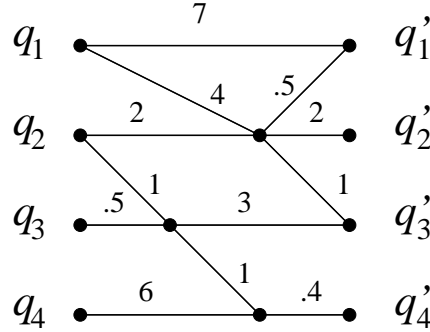

FIGURE 1. A planar network

More generally, we will define the weight a *multiset* of edges to be the analogous product in which weights of edges may appear with multiplicities greater than one. If  $m = (m_e)_{e \in F}$  is a vector of multiplicities which defines a multiset of edges in  $F$ , we will denote the weight of this multiset by  $\omega(F, m)$ .

Given a planar network  $G$  of order  $n$ , we will define a subgraph  $H$  of  $G$  to be a *planar subnetwork* of  $G$  if it is a planar network whose sources and sinks are precisely those of  $G$ . We will economize notation by writing  $H \subset G$  to denote that  $H$  is a planar subnetwork of  $G$ .

We define the *path matrix*  $A = [a_{i,j}]$  of a planar network  $G$  by letting  $a_{i,j}$  be the sum

$$a_{i,j} = \sum_{\pi} \omega(\pi),$$

of weights of paths over all paths  $\pi$  from source  $i$  ( $q_i$ ) to sink  $j$  ( $q'_j$ ). The reader may verify that the path matrix of the planar network in Figure 1 is

$$(2.2) \quad \begin{bmatrix} 984 & 0 \\ 145 & .4 \\ 003 & .2 \\ 0002.4 \end{bmatrix}.$$

and that this matrix is TNN. (In figures we will assume that all edges are directed from left to right.)

The following famous theorem of Lindström and others [1] [5] [6] [13] [16] [17] explains the connection between planar networks and TNN matrices. (See also [10].)

**Theorem 2.1.** *An  $n \times n$  matrix  $A$  is totally nonnegative if and only if it is the path matrix of a planar network  $G$  of order  $n$ . Furthermore, for any  $k$ -element subsets  $I = \{i_1, \dots, i_k\}$ ,  $I' = \{i'_1, \dots, i'_k\}$  of  $[n]$ , the  $(I, I')$  minor of  $A$  has the combinatorial interpretation*

$$\Delta_{I,I'}(A) = \sum_{\Pi} \omega(\Pi),$$

where the sum is over all  $k$ -tuples  $\Pi = (\pi_1, \dots, \pi_k)$  of paths in  $G$  which satisfy

- (1)  $\pi_j$  is a path from  $q_{i_j}$  to  $q'_{i'_j}$ .
- (2)  $\pi_j$  and  $\pi_\ell$  do not intersect for  $j \neq \ell$ .

The reader may verify that the graph in Figure 1 has three nonintersecting path families from  $\{q_1, q_2\}$  to  $\{q'_1, q'_3\}$ , and that these families have weights 14, 21, and 6. Correspondingly, the  $(\{1, 2\}, \{1, 3\})$ -minor of the path matrix (2.2) is  $41 = 14 + 21 + 6$ .

Immediate consequences of Theorem 2.1 are combinatorial interpretations for certain TNN immanants. Fix a planar network  $G$  and its path matrix  $A$ . The application of the monomial  $x_{1,\sigma(1)} \cdots x_{n,\sigma(n)}$  to  $A$  has

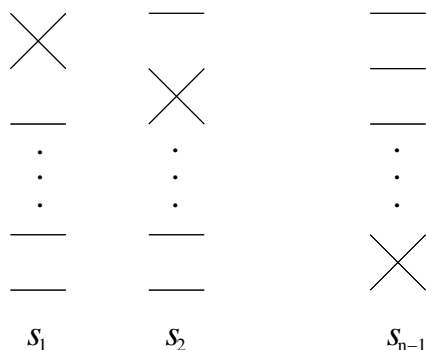

FIGURE 2. Planar networks for the generators of  $S_n$ .

the interpretation

$$a_{1,\sigma(1)} \cdots a_{n,\sigma(n)} = \sum_{\Pi} \omega(\Pi),$$

where the sum is over path families  $\Pi = (\pi_1, \dots, \pi_n)$  in  $G$  in which  $\pi_i$  is a path from  $q_i$  to  $q'_{\sigma(i)}$ . We will say that such a path family has *type*  $\sigma$ . Also, by choosing  $I = I' = [n]$  in Theorem 2.1, we have that

$$\det(A) = \sum_{H \subset G} \omega(H),$$

where the sum is over all planar subnetworks  $H$  of  $G$  which are unions of  $n$  nonintersecting paths. With a bit more work, one can derive a similar combinatorial interpretation for the TNN immanants (1.5),

$$\Delta_{J,J'}(A)\Delta_{\overline{J},\overline{J'}}(A) - \Delta_{I,I'}(A)\Delta_{\overline{I},\overline{I'}}(A) = \sum_{H \in \mathcal{H}} c_H \omega(H),$$

for appropriate collections  $\mathcal{H}$  of planar subnetworks which depend on the index sets  $I, J$ , etc., and for appropriate constants  $c_H$ . (See [19, Cor. 3.3].) The problem of finding an analogous combinatorial interpretation for the TNN immanants (1.2) and (1.3) remains open.

To construct more TNN polynomials, we shall examine the planar networks of order  $n$  which are unions of  $n$  paths. We will say that a path family  $\Pi$  *covers* a planar network  $H = (V, E)$  if every edge in  $E$  belongs to a path in  $\Pi$ . Since two different path families may cover the edges of a planar network with different multiplicities, we introduce the following notation. Given a planar network  $H = (V, E)$  of order  $n$ , a sequence  $m = (m_e)_{e \in E}$  of positive multiplicities, and a permutation  $\sigma$  in  $S_n$ , we define the number  $\gamma(G, \sigma, m)$  to be the number of path families  $\Pi$  of type  $\sigma$  which cover  $H$  in such a way that each edge  $e$  belongs to exactly  $m_e$  paths. Note that we may assume that the components of  $m$  belong to  $[n]$ , since each edge of  $G$  will be covered at least once and at most  $n$  times by  $n$  paths. To enumerate the path families which cover  $H$ , we will associate to  $H$  an element  $\beta(H)$  in  $\mathbb{Z}[S_n]$  which will serve as an unweighted path generating function,

$$\beta(H) = \sum_m \sum_{\sigma \in S_n} \gamma(H, \sigma, m)\sigma,$$

where the first sum is over sequences  $m$ .

Certain planar networks which appear often in conjunction with the symmetric group are called *wiring diagrams*. Specifically, to the generators  $s_1, \dots, s_{n-1}$  of  $S_n$  we associate the planar networks in Figure 2. Then to an expression

$$\sigma = s_{i_1} \cdots s_{i_k}$$



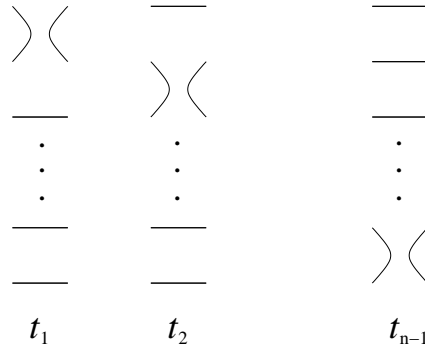

FIGURE 5. Generators of  $t^n \lambda$ .

The path generating functions of generalized wiring diagrams factor just as those of wiring diagrams. On the other hand, the path generating functions of arbitrary unions of  $n$  paths do not factor this way. Figure 4 (b) shows a planar network whose path generating function is  $1 + s_2 + s_3 + s_2 s_3 + s_3 s_2 + s_2 s_3 s_2$ . We will denote by  $u_{[i,j]}$  the element of  $\mathbb{Z}[S_n]$  which is a sum of permutations in the subgroup generated by  $s_i, \dots, s_{j-1}$ .

**Lemma 2.3.** *Let  $H$  be a planar network which is a union of  $n$  paths. If  $H$  is a generalized wiring diagram then  $\beta(H)$  factors as*

$$\beta(H) = (1 + s_{i_1}) \cdots (1 + s_{i_k})$$

for some generators  $s_{i_1}, \dots, s_{i_k}$  of  $S_n$ . If  $H$  is not a generalized wiring diagram, then  $\beta(H)$  can be expressed as a sum of terms of the form

$$u_{[i_1, j_1]} \cdots u_{[i_k, j_k]},$$

where in each such term we have  $i_\ell \leq j_\ell - 2$  for at least one index  $\ell$ .

PROOF. Omitted. □

### 3. Main results

Given an integer  $\lambda$ , we define the *Temperley-Lieb algebra*  $t^n \lambda$  to be the  $\mathbb{Z}$ -algebra generated by elements  $t_1, \dots, t_{n-1}$  subject to the relations

$$\begin{aligned} t_i^2 &= \lambda t_i, & \text{for } i = 1, \dots, n-1, \\ t_i t_j t_i &= t_i, & \text{if } |i - j| = 1, \\ t_i t_j &= t_j t_i, & \text{if } |i - j| \geq 2. \end{aligned}$$

The rank of  $t^n \lambda$  as a  $\mathbb{Z}$ -module is well known to be the  $n$ th Catalan number  $C_n = \frac{1}{n+1} \binom{2n}{n}$ .

$t^n 2$  is isomorphic to the quotient  $\mathbb{Z}[S_n]/I$ , where  $I$  is the ideal generated by  $u_{[1,3]}, u_{[2,4]}, \dots, u_{[n-2,n]}$ . (See [12, Sec. 2.1].) The isomorphism is given by

$$\begin{aligned} \theta : \mathbb{Z}[S_n] &\rightarrow t^n 2, \\ s_i &\mapsto t_i - 1. \end{aligned}$$

We will call the elements of the multiplicative monoid generated by  $t_1, \dots, t_{n-1}$  the *basis elements* of  $t^n \lambda$ .

Figure 5 shows pictorial representations of the basis elements of  $t^n \lambda$  which were made popular by Kauffman [14, Sec. 4]. Multiplication of generators corresponds to concatenation of diagrams, with cycles contributing  $\lambda$ . Figure 6 shows the multiplication  $t_1 t_2 t_1 t_3 = \lambda t_1 t_3$  in  $T_4(\lambda)$ . (We “tighten” long curves to simplify the picture.)

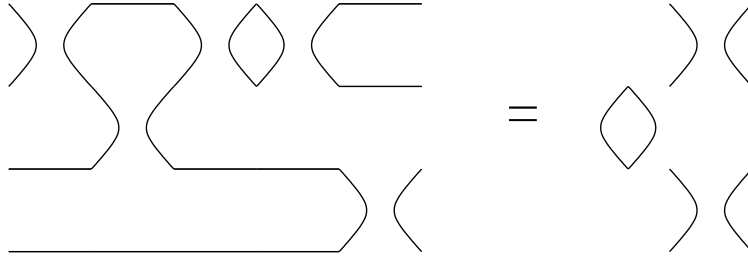

FIGURE 6. Multiplication in  $\mathfrak{t}^n \lambda$ .

For any basis element  $\tau$  of  $\mathfrak{t}^n 2$ , define  $f_\tau : S_n \rightarrow \mathbb{R}$  to be the function which maps  $\sigma$  to the coefficient of  $\tau$  in  $\theta(\sigma)$ .

Given a planar network  $H$  which is a union of  $n$  paths, define the element  $\phi_\lambda(H)$  of  $\mathfrak{t}^n \lambda$  by

$$\phi_\lambda(H) = \theta(\beta(H)).$$

If  $H$  is a generalized wiring diagram, then by Lemma 2.3, we have that

$$\phi_\lambda(H) = \theta(1 + s_{i_1}) \cdots \theta(1 + s_{i_k}) = t_{i_1} \cdots t_{i_k}$$

for some indices  $i_1, \dots, i_k \in [n]$  and therefore that

$$\phi_\lambda(H) = \lambda^j \tau$$

for some nonnegative integer  $j$  and some basis element  $\tau = \phi_1(H)$  of  $\mathfrak{t}^n \lambda$ . We will denote the exponent by  $\alpha(H)$ ,

$$\phi_\lambda(H) = \lambda^{\alpha(H)} \phi_1(H).$$

If, on the other hand,  $H$  is not a generalized wiring diagram, then by Lemma 2.3 we have that  $\beta(H)$  is equal to a sum of  $\mathbb{Z}[S_n]$  elements which belong to the kernel of  $\theta$ . It follows in this case that  $\phi_\lambda(H) = 0$ . If  $H$  is a generalized wiring diagram, then  $\phi_\lambda(H)$  can be computed pictorially as follows.

- (1) Contract any doubly covered subpath to a single vertex.
- (2) For each vertex  $v$  of indegree two and outdegree two, create vertex  $v'$  with indegree two and vertex  $v''$  with outdegree two.
- (3) Interpret the resulting graph as an element of  $\mathfrak{t}^n \lambda$ . (See Figures 3 and 6.)

**Lemma 3.1.** *Let  $H$  be a planar network which is a union of  $n$  paths. For any basis element  $\tau$  of  $\mathfrak{t}^n 2$  we have*

$$\sum_{\Pi} f_\tau(\text{type}(\Pi)) = \begin{cases} 2^{\alpha(H)} & \text{if } \phi_1(H) = \tau, \\ 0 & \text{otherwise,} \end{cases}$$

where the sum is over path families  $\Pi$  which cover  $H$ .

PROOF. Note that we have

$$\sum_{\Pi} f_\tau(\text{type}(\Pi)) = \sum_m \sum_{\sigma \in S_n} \gamma(H, \sigma, m),$$

which is equal to the coefficient of  $\tau$  in

$$(3.1) \quad \theta \left( \sum_m \sum_{\sigma \in S_n} \gamma(H, \sigma, m) \sigma \right) = \theta(\beta(H)) = \phi_2(H).$$

This coefficient is  $2^{\alpha(H)}$  if  $\phi_1(H) = \tau$  and is zero otherwise. □

We may now state and prove our main result.

**Theorem 3.2.** *For any basis element  $\tau$  of  $\mathfrak{t}^n 2$ , the  $f_\tau$ -immanant  $\text{Imm}_{f_\tau}(x)$  is totally nonnegative. In particular, let  $G$  be a planar network of order  $n$  and let  $A$  be its path matrix. Then we have*

$$\text{Imm}_{f_\tau}(A) = \sum_{H \subset G} 2^{\alpha(H)} \omega(H, m),$$

where the sum is over all planar subnetworks  $H$  of  $G$  which are generalized wiring diagrams and which satisfy  $\phi_1(H) = \tau$ , and  $m$  is the vector of edge multiplicities which is uniquely determined by  $H$ .

PROOF. We have

$$\begin{aligned} \text{Imm}_{f_\tau}(A) &= \sum_{\sigma \in S_n} f_\tau(\sigma) a_{1,\sigma(1)} \cdots a_{n,\sigma(n)} \\ &= \sum_{\sigma \in S_n} f_\tau(\sigma) \sum_{H \subset G} \sum_m \omega(H, m) \gamma(H, \sigma, m), \end{aligned}$$

where the second sum is over all planar subnetworks  $H$  of  $G$  which are unions of  $n$  paths. Changing the order of summation, we have

$$\begin{aligned} \text{Imm}_{f_\tau}(A) &= \sum_{H \subset G} \sum_m \omega(H, m) \sum_{\sigma \in S_n} f_\tau(\sigma) \gamma(H, \sigma, m) \\ &= \sum_{H \subset G} \sum_m \omega(H, m) \sum_{\Pi} f_\tau(\text{type}(\Pi)), \end{aligned}$$

where the inner sum is over all path families  $\Pi$  which cover  $H$  with edge multiplicities  $m$ . By Lemma 3.1, this inner sum is  $2^{\alpha(H)}$  if  $H$  is a generalized wiring diagram, and zero otherwise. In the case that  $H$  is a generalized wiring diagram, then Lemma 2.2 implies that the sequence  $m$  is completely determined by  $H$ , and we have our desired result. □

#### 4. Improved criterion

Now let us associate to each pair of  $k$ -subsets  $(I, I')$  of  $[n]$  a subset of the basis elements of  $\mathfrak{t}^n \lambda$ . Labeling the vertices of a basis element generator  $\tau$  by  $q_1, \dots, q_n, q'_n, \dots, q'_1$  (counterclockwise), let us say that  $\tau$  is compatible with the pair  $(I, I')$  if each edge is incident upon exactly one of the vertices  $\{q_i \mid i \in I\} \cup \{q'_j \mid j \in \overline{I'}\}$ .

**Theorem 4.1.** *Let  $I, I', J, J'$  be subsets of  $[n]$  satisfying  $|I| = |I'|$  and  $|J| = |J'|$ , and let  $R(I, I')$ ,  $R(J, J')$  be the subsets of basis elements of  $\mathfrak{t}^n \lambda$  which are compatible with  $(I, I')$  and  $(J, J')$ , respectively. The immanant  $\Delta_{J, J'}(x) \Delta_{\overline{J}, \overline{J'}}(x) - \Delta_{I, I'}(x) \Delta_{\overline{I}, \overline{I'}}(x)$  is totally nonnegative if and only if  $R(I, I')$  is contained in  $R(J, J')$ . In particular, we have*

$$\Delta_{J, J'}(x) \Delta_{\overline{J}, \overline{J'}}(x) - \Delta_{I, I'}(x) \Delta_{\overline{I}, \overline{I'}}(x) = \sum_{\tau \in R(J, J') \setminus R(I, I')} \text{Imm}_{f_\tau}(x).$$

PROOF. Omitted. □

#### 5. Acknowledgements

The authors are grateful to Sergey Fomin, Rosa Orellana, Richard Stanley, John Stembridge, Brian Drake, Sean Gerrish, Michal Ostrowski, Nina Palmo, Zachary Pavlov, Randy Pistor, and Andrew Wagner for many helpful conversations.

## References

- [1] M. AISSÉN, I. J. SCHOENBERG, AND A. WHITNEY. On generating functions of totally positive sequences. *J. Anal. Math.*, **2** (1952) pp. 93–103.
- [2] J. BELL AND M. SKANDERA. Multicomplexes and polynomials with real zeros, 2003. In progress.
- [3] A. BERENSTEIN AND A. ZELEVINSKY. String bases for quantum groups of type  $A_r$ . *Adv. Sov. Math.*, **16** (1993) pp. 51–89.
- [4] A. BERENSTEIN AND A. ZELEVINSKY. Canonical bases for the quantum groups of type  $A_r$  and piecewise linear combinatorics. *Duke Math. J.*, **82** (1996) pp. 473–502.
- [5] F. BRENTI. Combinatorics and total positivity. *J. Combin. Theory Ser. A*, **71** (1995) pp. 175–218.
- [6] C. W. CRYER. Some properties of totally positive matrices. *Linear Algebra Appl.*, **15** (1976) pp. 1–25.
- [7] B. DRAKE, S. GERRISH, AND M. SKANDERA. Two new criteria for comparison in the Bruhat order. *Electron. J. Combin.*, (to appear).
- [8] S. M. FALLAT, M. I. GEKHTMAN, AND C. R. JOHNSON. Multiplicative principal-minor inequalities for totally nonnegative matrices. *Adv. Appl. Math.*, **30** (2003) pp. 442–470.
- [9] S. FOMIN, 2002. Personal communication.
- [10] S. FOMIN AND A. ZELEVINSKY. Total positivity: Tests and parametrizations. *Math. Intelligencer*, **22** (2000) pp. 23–33.
- [11] I. GELFAND AND A. ZELEVINSKY. Canonical basis in irreducible representations of  $gl_3$  and its applications. In *Group Theoretical Methods in Physics, Vol. II (Jurmala, 1985)*. VNU Sci. Press, Utrecht, 1986 pp. 127–146.
- [12] F. M. GOODMAN, P. DE LA HARPE, AND V. JONES. *Coxeter Graphs and Towers of Algebras*. Springer–Verlag, New York, 1989.
- [13] S. KARLIN AND G. MCGREGOR. Coincidence probabilities. *Pacific J. Math.*, **9** (1959) pp. 1141–1164.
- [14] L. KAUFFMAN. State models and the Jones polynomial. *Topology*, **26** (1987) pp. 395–407.
- [15] B. KOSTANT. Immanant inequalities and 0-weight spaces. *J. Amer. Math. Soc.*, **8** (1995) pp. 181–186.
- [16] B. LINDSTRÖM. On the vector representations of induced matroids. *Bull. London Math. Soc.*, **5** (1973) pp. 85–90.
- [17] C. LOEWNER. On totally positive matrices. *Math. Z.*, **63** (1955) pp. 338–340.
- [18] G. LUSZTIG. Total positivity in reductive groups. In *Lie Theory and Geometry: in Honor of Bertram Kostant*, vol. 123 of *Progress in Mathematics*. Birkhäuser, Boston, 1994 pp. 531–568.
- [19] M. SKANDERA. Inequalities in products of minors of totally nonnegative matrices. *J. Alg. Combin.*, (to appear).
- [20] J. STEMBRIDGE. Immanants of totally positive matrices are nonnegative. *Bull. London Math. Soc.*, **23** (1991) pp. 422–428.
- [21] J. STEMBRIDGE. Some conjectures for immanants. *Can. J. Math.*, **44** (1992) pp. 1079–1099.

DEPT. OF MATHEMATICS, UNIVERSITY OF MICHIGAN, 2074 EAST HALL, ANN ARBOR, MI 48109-1109  
*E-mail address:* brhoades@umich.edu

DEPT. OF MATHEMATICS, DARTMOUTH COLLEGE, 6188 BRADLEY HALL, HANOVER, NH 03755-3551  
*URL:* <http://www.math.dartmouth/~skan>  
*E-mail address:* mark.skandera@dartmouth.edu







# The weak and Kazhdan-Lusztig orders on standard Young tableaux

Victor Reiner and Muge Taskin

**Abstract.** Let  $SYT_n$  be the set of all standard Young tableaux with  $n$  cells. After recalling the definition of a partial order on  $SYT_n$  first defined by Melnikov, which we call the weak order, we prove two main results:

- Intervals in the weak order essentially describe the product in a Hopf algebra of tableaux defined by Poirier and Reutenauer.
- The map sending a tableau to its descent set induces a homotopy equivalence of the proper parts of either weak order or Kazhdan-Lusztig order on tableaux with the Boolean algebra  $2^{[n-1]}$ . In particular, the Möbius function for either of these orders on tableaux is  $(-1)^{n-1}$ .

The methods use in an essential way the Kazhdan-Lusztig order on  $SYT_n$ , and in some cases apply to other orders between the weak order and  $KL$ -order.

## 1. Introduction

The weak order on standard Young tableaux was introduced by Melnikov [15] (who called it the *induced Duflo order*), in connection with the Robinson-Schensted ( $RSK$ ) correspondence and the weak Bruhat order on permutations. Roughly speaking, this order is the weakest partial ordering on  $SYT_n$ , such that the map from the weak Bruhat order on the symmetric group  $S_n$  which takes a permutation  $w$  to its  $RSK$  insertion tableau  $P(w)$  is order preserving; see Figure 1 for  $n = 2, 3, 4, 5$ .

This order is closely related to the Kazhdan-Lusztig preorder on the symmetric group, and the partial order on  $SYT_n$  that it induces, which we will call the  $KL$  order. In general, the weak order on  $SYT_n$  is weaker than the  $KL$  order, although they are equivalent up to  $n = 5$ . The goal of this paper is to prove two main results, Theorems 1.1 and 1.2, about the weak and  $KL$  orders on  $SYT_n$ .

The first result relates to algebra structures defined by Malvenuto and Reutenauer, Poirier and Reutenauer, and is motivated by results of Loday and Ronco [13]; the same result was also asserted without proof in [8, middle of p. 579]. Malvenuto and Reutenauer [14] defined a (Hopf) algebra structure on  $\mathbb{Z}\mathfrak{S} = \bigoplus_{n \geq 0} \mathbb{Z}\mathfrak{S}_n$ , whose product sends a pair of permutations  $u, v$  to the sum of all shuffles  $\text{sh}(u, v)$  of  $u$  and  $v$  (after raising the values of all letters in  $v$  by the length of  $u$ ). Poirier and Reutenauer [17] observed that this product restricts to a product on the subalgebra spanned by sums over Knuth/plactic classes in  $\mathfrak{S}_n$  (or right Kazhdan-Lusztig cells), which are indexed by Young tableaux  $T$ . This defines the product  $T * S$  in the Poirier-Reutenauer Hopf algebra  $\mathbb{Z}SYT = \bigoplus_{n \geq 0} \mathbb{Z}SYT_n$ . The following is proven in Section 3, where  $T/S$  and  $T \setminus S$  are defined more precisely.

**Theorem 1.1.**

$$T * S = \sum_{\substack{R \in SYT_n: \\ T/S \leq_{\text{weak}} R \leq_{\text{weak}} T \setminus S}} R$$

---

This research of both authors was partially supported by NSF grant DMS-9877047.

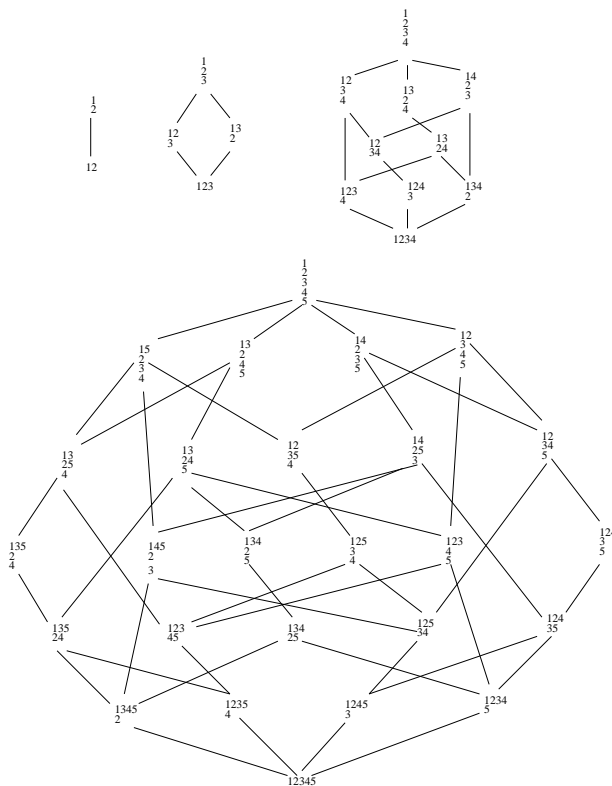

FIGURE 1. The weak order and the  $KL$ -order on  $SYT_n$ , which coincide for  $n = 2, 3, 4, 5$  (but not in general).

where  $T/S$  and  $T \setminus S$  are obtained by sliding  $S$  over  $T$  from the left and from the bottom respectively.

The second main result is about the Möbius function and homotopy type for the weak order and  $KL$ -order on  $SYT_n$ . The weak Bruhat order on  $\mathfrak{S}_n$  is well-known to have each interval homotopy equivalent to either a sphere or a point, and hence have Möbius function values all in  $\{\pm 1, 0\}$ . This is false for intervals in general in  $(SYT_n, \leq_{weak})$ ; see Figure 2 below. However, it is true for the interval from bottom to top.

**Theorem 1.2.** *Let  $\leq$  be any partial order on  $SYT_n$  that lies between  $\leq_{weak}$  and  $\leq_{KL}$  (e.g.  $\leq_{weak}$  or  $\leq_{KL}$  itself).*

*Then the map of sets  $SYT_n \mapsto 2^{[n-1]}$  sending a tableau to its descent set is order-preserving, and induces a homotopy equivalence of proper parts. In particular,  $\mu(\hat{0}, \hat{1}) = (-1)^{n-1}$  for any such order.*

To clarify the context and motivation for Theorems 1.1 and 1.2, we recall two commutative diagrams appearing in the work of Loday and Ronco [13]

$$(1.1) \quad \begin{array}{ccccc} \mathfrak{S}_n & \longrightarrow & Y_n & & \mathbb{Z}\mathfrak{S} \longleftarrow \mathbb{Z}Y \\ & \searrow & \downarrow & & \swarrow \uparrow \\ & & 2^{[n-1]} & & \Sigma \end{array} .$$

In the left diagram,  $Y_n$  denotes the set of plane binary trees with  $n$  vertices. The horizontal map sends a permutation  $w$  to a certain tree  $T(w)$ , and has been considered in many contexts (see e.g. [22, §1.3], [5, §9]). The southeast map  $\mathfrak{S}_n \rightarrow 2^{[n-1]}$  sends a permutation  $w$  to its descent set  $\text{Des}_L(w)$ . These maps of sets become order-preserving if one orders  $\mathfrak{S}_n$  by weak order,  $Y_n$  by the *Tamari order* (see [5, §9]), and  $2^{[n-1]}$  by inclusion. In [5, Remark 9.12], Björner and Wachs (essentially) show that the triangle on the left induces a

diagram of homotopy equivalences on the proper parts of the posets involved. Theorem 1.2 and the stronger assertion in Corollary 4.3 below give the analogue of this statement in which one replaces  $(Y_n, \leq_{Tamari})$  by  $(SYT_n, \leq_{weak})$ . We were further motivated in proving Theorem 1.2 by the results of Aguiar and Sottile [1], where the Möbius function of the weak order on  $\mathfrak{S}_n$  plays a role in understanding the structure of the Malvenuto-Reutenauer algebra.

The second diagram in (1.1) consists of induced inclusions of Hopf algebras, in which  $\mathbb{Z}\mathfrak{S}$  is the Malvenuto-Reutenauer algebra,  $\mathbb{Z}Y$  is a subalgebra isomorphic to Loday and Ronco’s free *dendriform algebra* on one generator [12], and  $\Sigma$  is a subalgebra known as the algebra of *noncommutative symmetric functions*. In [13], Loday and Ronco proved a description of the product structure for each of these three algebras very much analogous to Theorem 1.1, which should be viewed as the analogue replacing  $\mathbb{Z}Y$  by  $\mathbb{Z}SYT$ .

The analogy between the standard Young tableaux  $SYT_n$  and the plane binary trees  $Y_n$  is tightened further by recent work of Hivert, Novelli and Thibon [8]. They show that the planar binary trees  $Y_n$  can be interpreted as the plactic monoid structure given by a Knuth-like relation similar to the interperation of the set of standard Young tableaux as Knuth/plactic classes.

## 2. Definition and properties of the weak order on $SYT_n$

Before giving the definition of the weak order, it is necessary to recall the Robinson-Schensted ( $RSK$ ) correspondence; see [18, §3] for more details and references on  $RSK$ . The  $RSK$  correspondence is a bijection between  $\mathfrak{S}_n$  and  $\{(P, Q) : P, Q \in SYT_n \text{ of same shape}\}$ . Here  $P$  and  $Q$  are called the *insertion* and *recording tableau* respectively. Knuth [11] defined an equivalence relation  $\sim_K$  on  $\mathfrak{S}_n$  with the property that  $\sigma \sim_K \tau$  if and only if they have the same insertion tableaux  $P(\sigma) = P(\tau)$ .

It turns out that  $RSK$  is closely related to the *Kazhdan-Lusztig* preorders on  $\mathfrak{S}_n$ . Recall that a *preorder* on a set  $X$  is a binary relation  $\leq$  which is reflexive ( $x \leq x$ ) and transitive ( $x \leq y, y \leq z$  implies  $x \leq z$ ). It need not be antisymmetric, that is, the equivalence relation  $x \sim y$  defined by  $x \leq y, y \leq x$  need not have singleton equivalence classes. Note that a preorder induces a *partial order* on the set  $X/\sim$  of equivalence classes. Kazhdan and Lusztig [9] introduced two preorders (the left and right  $KL$  preorders) on Coxeter groups. In this paper we will denote by  $\leq_{KL}^{op}$  the *opposite* of the usual  $KL$  right preorder on  $\mathfrak{S}_n$ . For example, with our convention, the identity element 1 and the longest element  $w_0$  satisfy  $1 \leq_{KL}^{op} w_0$ . It turns out [9] (and explicitly in [6, p. 54]) that the associated equivalence relation for this  $KL$  preorder is the Knuth equivalence  $\sim_K$ . Hence an equivalence class (usually called either a *Knuth class* or *plactic class* or a *Kazhdan-Lusztig right cell* in  $\mathfrak{S}_n$ ) corresponds to a tableau  $T$  in  $SYT_n$ . Denote this equivalence class  $C_T$ . We denote by  $(SYT_n, \leq_{KL}^{op})$  the partial order induced by the  $KL$  preorder.

**Proposition 2.1.** *Let  $\leq$  be any preorder on  $\mathfrak{S}_n$  which is weaker than  $\leq_{KL}^{op}$ . Then  $\leq$  induces an order on  $SYT_n$ , by taking the transitive closure of the relation which has  $S \leq T$  whenever  $\sigma \leq \tau$  for some  $\sigma, \tau$  in  $\mathfrak{S}_n$  with  $P(\sigma) = S, P(\tau) = T$ .*

*Furthermore, the map  $(\mathfrak{S}, \leq) \rightarrow (SYT_n, \leq)$  sending  $\sigma \mapsto P(\sigma)$  is order-preserving.*

PROOF. Straightforward, but omitted in this extended abstract. □

We now recall the (*right*) *weak (Bruhat) order*  $\leq_{weak}$   $\mathfrak{S}_n$ . It is the transitive closure of the relation  $\sigma \leq_{weak} \tau$  if  $\tau = \sigma \cdot s_i$  for some  $i$  with  $\sigma_i < \sigma_{i+1}$ , and where  $s_i$  is the adjacent transposition  $(i \ i + 1)$ . The weak order has an alternative characterization [3, Prop. 3.1] in terms of (*left*) *inversion sets*

$$\text{Inv}_L(\sigma) := \{(i, j) : 1 \leq i < j \leq n \text{ and } \sigma^{-1}(i) > \sigma^{-1}(j)\},$$

namely  $\sigma \leq_{weak} \tau$  if and only if  $\text{Inv}_L(\sigma) \subset \text{Inv}_L(\tau)$ .

It is known [9, page 171] that the (*right*) weak order  $\leq_{weak}$  on  $\mathfrak{S}_n$  is weaker than the (*right*)  $KL$  preorder  $\leq_{KL}^{op}$  on  $\mathfrak{S}_n$ , leading to the following definition.

**Definition 2.2.** The *weak order*  $(SYT_n, \leq_{weak})$ , first introduced by Melnikov [15] under the name *induced Duflo order*, is the partial order induced by  $(\mathfrak{S}_n, \leq_{weak})$  via Proposition 2.1.

Implicitly the definition of  $(SYT_n, \leq_{weak})$  involves taking transitive closure; the necessity of this is illustrated by the following example (cf. Melnikov [15, Example 4.3.1]).

**Example 2.3.** Let  $R = \begin{smallmatrix} 125 \\ 34 \end{smallmatrix}$ ,  $S = \begin{smallmatrix} 145 & 14 \\ 3 \end{smallmatrix}$ ,  $T = \begin{smallmatrix} 25 \\ 3 \end{smallmatrix}$  with

$$\begin{aligned} C_R &= \{31425, 34125, 31452, 34152, 34512\}, \\ C_S &= \{32145, 32415, 32451, 34215, 34251, 34521\}, \\ C_T &= \{32154, 32514, 35214, 32541, 35241\}. \end{aligned}$$

Here  $R <_{weak} S$  since  $34125 <_{weak} 34215 = 34125 \cdot s_3$ , and  $S <_{weak} T$  since  $32145 <_{weak} 32154 = 32145 \cdot s_4$ . Therefore  $R < T$ .

On the other hand, for every  $\rho \in C_R$  one has  $(2, 4) \in \text{Inv}_L(\rho)$ , whereas for every  $\tau \in C_T$  one has  $(2, 4) \notin \text{Inv}_L(\tau)$ . This shows that there is no  $\rho \in C_R$  and  $\tau \in C_T$  such that  $\rho <_R \tau$ .

It happens that  $(SYT_n, \leq_{weak})$  and  $(SYT_n, \leq_{KL}^{op})$  coincide for  $n \leq 5$ , but the following examples show that they differ for  $n = 6$ .

**Example 2.4.** Let

$$S = \begin{smallmatrix} 123 \\ 456 \end{smallmatrix}, \quad T_1 = \begin{smallmatrix} 125 \\ 36 \\ 4 \end{smallmatrix}, \quad T_2 = \begin{smallmatrix} 136 \\ 24 \\ 5 \end{smallmatrix}$$

Computer calculations show that  $S \leq_{KL}^{op} T_1, T_2$ , but  $S \not\leq_{weak} T_1, T_2$ . By using the anti-automorphism of  $\leq_{KL}^{op}, \leq_{weak}$  that transposes a standard Young tableau (see Proposition 2.6) one obtains two more examples of pairs of tableaux which are comparable in  $\leq_{KL}^{op}$ , but not in  $\leq_{weak}$ . These are the *only* such examples in  $SYT_6$ .

An important property of both  $\leq_{weak}$  and  $\leq_{KL}^{op}$  are their interactions with descent sets. The *(left) descent set* of a permutation  $\sigma$  is defined by

$$\begin{aligned} \text{Des}_L(\sigma) &:= \{(i, i + 1) : 1 \leq i \leq n - 1 \text{ and } \sigma^{-1}(i) > \sigma^{-1}(i + 1)\} \\ &= \text{Inv}_L(\sigma) \cap S \end{aligned}$$

where  $S = \{(i, i + 1) : 1 \leq i \leq n - 1\}$ . In what follows, we will often identify the set  $S$  of adjacent transposition with the numbers  $[n - 1] := \{1, 2, \dots, n - 1\}$  via the obvious map  $(i, i + 1) \mapsto i$ .

Property (i) in the next proposition is well-known [9, Prop. 2.4], and property (ii) follows from the characterization of  $\leq_{weak}$  by inclusion of left inversion sets.

**Proposition 2.5.** For  $\sigma, \tau$  in  $\mathfrak{S}_n$ ,

- (i)  $\sigma \leq_{KL}^{op} \tau$  implies  $\text{Des}_L(\sigma) \subset \text{Des}_L(\tau)$ .
- (ii)  $\sigma \leq_{weak} \tau$  implies  $\text{Des}_L(\sigma) \subset \text{Des}_L(\tau)$ .

As a consequence of this proposition (or well-known properties of  $RSK$ ), the left descent set  $\text{Des}_L(-)$  is constant on Knuth classes  $C_T$ ; the *descent set* of the standard Young tableau  $T$  is described intrinsically by

$$\begin{aligned} \text{Des}(T) &:= \{(i, i + 1) : 1 \leq i \leq n - 1 \text{ and} \\ &\quad i + 1 \text{ appears in a row below } i \text{ in } T\}. \end{aligned}$$

For the record, we note here some well-known symmetries of  $\leq_{weak}$  and  $\leq_{KL}^{op}$  on  $SYT_n$ , and some obvious order-preserving maps to other posets. Let  $(2^{[n-1]}, \subseteq)$  be the Boolean algebra of all subsets of  $[n - 1]$  ordered by inclusion. Let  $(\text{Par}_n, \leq_{dom})$  denote the set of all partitions of the number  $n$  ordered by *dominance*, that is,  $\lambda \leq_{dom} \mu$  if

$$\lambda_1 + \dots + \lambda_k \leq \mu_1 + \dots + \mu_k \text{ for all } k.$$

**Proposition 2.6.** The following maps are order-preserving:

(i) The map

$$(SYT_n, \leq_{weak}) \rightarrow (2^{[n-1]}, \subseteq)$$

sending a tableau  $T$  to its descent set  $\text{Des}(T)$ .

(ii) The same map

$$(SYT_n, \leq_{KL}^{op}) \rightarrow (2^{[n-1]}, \subseteq).$$

(iii) The map

$$(SYT_n, \leq_{weak}) \rightarrow (\text{Par}_n, \leq_{dom})^{opp}$$

sending  $T$  to its shape  $\lambda(T)$ , where here  $(-)^{opp}$  denotes the opposite or dual poset.

Also, Schützenberger’s evacuation map [20] on  $SYT_n$  gives a poset automorphism of both  $\leq_{weak}$  and  $\leq_{KL}^{op}$ , and the transpose map on  $SYT_n$  gives a poset anti-automorphism of both.

PROOF. The first two assertions are immediate from Proposition 2.5 (i) and (ii). For (iii), one can apply Greene’s Theorem [7].

The assertions about transposing and evacuation follow from the fact that the involutive maps

$$w \mapsto w_0w \text{ and } w \mapsto ww_0$$

are antiautomorphisms of both  $(\mathfrak{S}_n, \leq_{KL}^{op})$  [6] and  $(\mathfrak{S}_n, \leq_{weak})$ . Hence  $w \mapsto w_0ww_0$  is an automorphism of both. On the other hand  $P(ww_0)$  is just the transpose tableau of  $P(w)$  [19] and  $P(w_0ww_0)$  is nothing but the evacuation of  $P(w)$  [20].  $\square$

### 3. The Hopf Algebra of $SYT_n$

Malvenuto and Reutenauer, in [14] construct two graded Hopf algebra structure on the  $\mathbb{Z}$  module of all permutations  $\mathbb{Z}S = \oplus_{n \geq 0} \mathbb{Z}S_n$  which are dual to each other, and shown to be free as associative algebras by Poirier and Reutenauer in [17]. The product structure of the one that concerns us here is given by,  $\alpha * \beta = \text{sh}(\alpha, \bar{\beta})$  where  $\bar{\beta}$  is obtained by increasing the indices of  $\beta$  by the length of  $\alpha$  and  $\text{sh}$  denotes the shuffle product.

Poirier and Reutenauer also show that  $\mathbb{Z}$  module of all plactic classes  $\{PC_T\}_{T \in SYT}$ , where  $PC_T = \sum_{P(\alpha)=T} \alpha$  becomes a Hopf subalgebra of permutations and the product is given by the formula

$$(3.1) \quad PC_T * PC_{T'} = \sum_{\substack{P(\alpha)=T \\ P(\beta)=T'}} \text{sh}(\alpha, \bar{\beta})$$

Then the bijection sending each plactic class to its defining tableau gives us a Hopf algebra structure on the  $\mathbb{Z}$  module of all standard Young tableaux,  $\mathbb{Z}SYT = \oplus_{n \geq 0} \mathbb{Z}SYT_n$ .

For example,

$$PC_{\begin{smallmatrix} 1 \\ 2 \end{smallmatrix}} * PC_{\begin{smallmatrix} 1 & 2 \\ 3 \end{smallmatrix}} = \text{sh}(21, 34) = PC_{\begin{smallmatrix} 1 & 3 & 4 \\ 2 \end{smallmatrix}} + PC_{\begin{smallmatrix} 1 & 4 \\ 2 \\ 3 \end{smallmatrix}}$$

since  $\text{sh}(21, 34) = 2134 + 2314 + 2341 + 3241 + 3421$ . In other words,

$$\frac{1}{2} * 12 = \frac{134}{2} + \frac{14}{3}.$$

Another approach to calculate the product of two tableaux is given in [17] where Poirier and Reutenauer explain this product using jeu de taquin slides. Our goal is to show that it can also be described by a formula using partial orders, analogous to a result of Loday and Ronco [13, Thm. 4.1]. To state their result, given  $\sigma \in \mathfrak{S}_k$  and  $\tau \in \mathfrak{S}_\ell$ , with  $n := k + \ell$ , let  $\bar{\tau}$  be obtained from  $\tau$  by adding  $k$  to each letter. Then let  $\sigma/\tau$  and  $\sigma \setminus \tau$  denote the concatenations of  $\sigma, \bar{\tau}$  and of  $\bar{\tau}, \sigma$ , respectively.

**Theorem 3.1.** For  $\tau \in \mathfrak{S}_k$  and  $\sigma \in \mathfrak{S}_\ell$ , with  $n := k + \ell$ , one has in the Malvenuto-Reutenauer Hopf algebra

$$\tau * \sigma = \sum_{\substack{\rho \in \mathfrak{S}_n: \\ \sigma/\tau \leq \rho \leq \sigma \setminus \tau}} \rho.$$

Equivalently, the shuffles  $\text{sh}(\sigma, \tau)$  are the interval  $[\sigma/\tau, \sigma \setminus \tau]_{\leq_{weak}}$ .

The next definition identifies a crucial property for transporting the Loday and Ronco result to  $SYT_n$ .

**Definition 3.2.** Given  $\sigma$  in  $\mathfrak{S}_n$ , and  $k \in [n]$ , let  $I$  and  $I^c$  be the initial and final segments  $I = [k]$  and  $I^c = [n] - [k] = [k + 1, n]$  of the alphabet  $[n]$ . Let  $\sigma_I$  and  $\sigma_{I^c}$  be the subwords of  $\sigma$  obtained by restricting to the alphabets  $I$  and  $I^c$ . Let  $\text{std}(\sigma_{I^c})$  in  $\mathfrak{S}_{n-k}$  be the word obtained from  $\sigma_{I^c}$  by subtracting  $k$  from each letter.

Say that a family of preorders  $\leq$  on  $\mathfrak{S}_n$  for all  $n$  restricts to initial and final segments if  $\sigma \leq \tau$  implies  $\sigma_I \leq \tau_I$  and  $\text{std}(\sigma_{I^c}) \leq \text{std}(\tau_{I^c})$ .

We need analogous definitions for tableaux. Given a tableaux  $T$  and  $k \in [n]$  with initial and final segments  $I = [k], I^c$  as before, let  $T_I$  denote subtableau of  $T$  obtained by restricting to the values in  $I$ . Let  $\text{std}(T_{I^c})$  denote the tableau obtained by first restricting  $T$  to its skew subtableau on the values in  $I^c$ , then lowering all these entries by  $k$ , and then sliding into normal shape by jeu-de-taquin [21].

The following are two basic facts about RSK, Knuth equivalence, and jeu-de-taquin are essentially due to Knuth and Schützenberger; see Knuth [10, Section 5.1.4] for detailed explanations.

**Lemma 3.3.** Given  $\rho \in \mathfrak{S}_n$  and  $k \in [n]$ , let  $I = [k], I^c$  be initial and final segments as before. Then

- (i)  $P(w_I) = P(w)_I$ , and
- (ii)  $\text{std}(P(w)_{I^c}) = P(\text{std}(w_{I^c}))$ .

Let  $\sigma \in \mathfrak{S}_k, \tau \in \mathfrak{S}_\ell$ . When  $P(\sigma) = S$  and  $P(\tau) = T$ , let  $\bar{T}$  denote the result of adding  $k$  to every entry of  $T$ . It is easily seen that  $P(\sigma/\tau) = S/T$  and  $P(\sigma \setminus \tau) = S \setminus T$ , where  $S/T$  (respectively,  $S \setminus T$ ) is the tableaux whose columns (resp. rows) are obtained by concatenating the columns (resp. rows) of  $S$  and  $\bar{T}$ . Note also that Lemma 3.3 shows

$$\begin{aligned} (S/T)_I &= S & \text{std}((S/T)_{I^c}) &= T \\ (S \setminus T)_I &= S & \text{std}((S \setminus T)_{I^c}) &= T. \end{aligned}$$

The following theorem is a consequence of Lemma 3.3, Proposition 2.1 and Theorem 3.1. For the sake of space we omit the detailed proof.

**Theorem 3.4.** Let  $\leq$  be a family of preorders on  $\mathfrak{S}_n$  for all  $n$  that

- (a) lies between  $\leq_{weak}$  and  $\leq_{KL}^{op}$ , and
- (b) restricts to initial and final segments.

Let  $(SYT_n, \leq)$  denote the partial order on tableaux which it induces as in Proposition 2.1.

Then in the Poirier-Reutenauer Hopf algebra,

$$S * T = \sum_{\substack{R \in SYT_n: \\ S/T \leq R \leq S \setminus T}} R.$$

*Proof of Theorem 1.1.* The poset  $(\mathfrak{S}_n, \leq_{weak})$  satisfies both hypotheses of Theorem 3.4: it lies between itself and  $\leq_{KL}^{op}$ , and its characterization via inclusion of left inversion sets shows immediately that it restricts to initial and final segments. □

**Example 3.5.** Let  $T = \begin{smallmatrix} 12 \\ 3 \end{smallmatrix}$  and  $S = P(\beta) = \begin{smallmatrix} 1 \\ 2 \end{smallmatrix}$ . Then the product on the corresponding the plactic classes gives

$$T * S = \begin{smallmatrix} 12 \\ 3 \end{smallmatrix} * \begin{smallmatrix} 1 \\ 2 \end{smallmatrix} = \begin{smallmatrix} 124 \\ 35 \end{smallmatrix} + \begin{smallmatrix} 124 \\ 3 \\ 5 \end{smallmatrix} + \begin{smallmatrix} 12 \\ 34 \\ 5 \end{smallmatrix} + \begin{smallmatrix} 12 \\ 3 \\ 4 \\ 5 \end{smallmatrix}.$$

On the other hand,  $T/S = \begin{smallmatrix} 124 \\ 35 \end{smallmatrix}$  and  $T \setminus S = \begin{smallmatrix} 12 \\ 4 \\ 5 \end{smallmatrix}$ . The Hasse diagram of  $SYT_5$  in Figure 1 shows that the product above is equal to the sum of all tableaux in the interval  $[T/S, T \setminus S]_{\leq_{weak}}$ .

#### 4. Möbius function and homotopy equivalences

In this section, we prove Theorem 1.2, but in greater generality. We will view the the commutative diagram

$$(4.1) \quad \begin{array}{ccc} S_n & \longrightarrow & SYT_n \\ & \searrow & \downarrow [n-1] \\ & & 2^{[n-1]} \end{array}$$

as an instance of the following set-up, involving closure relations, equivalence relations, order-preserving maps, and the topology of posets. For background on poset topology, see [2].

Let  $P$  be a partial order and  $p \mapsto \bar{p}$  a closure relation on  $P$ , that is,

$$\bar{\bar{p}} = \bar{p}, \quad p \leq_P \bar{p} \quad \text{and} \quad p \leq_P q \text{ implies } \bar{p} \leq_P \bar{q}.$$

It is well-known that in this instance, the order-preserving closure map  $P \rightarrow \bar{P}$  has the property that its associated simplicial map of order complexes  $\Delta(P) \rightarrow \Delta(\bar{P})$  is a strong deformation retraction.

Now assume  $\sim$  be an equivalence relation on  $P$  such that, as maps of sets, the closure map  $P \rightarrow \bar{P}$  factors through the quotient map  $P \rightarrow P/\sim$ . Equivalently, the vertical map below is well-defined, and makes the diagram commute:

$$(4.2) \quad \begin{array}{ccc} P & \longrightarrow & P/\sim \\ & \searrow & \downarrow \\ & & \bar{P} \end{array}$$

**Proposition 4.1.** *In the above situation, partially order  $\bar{P}$  by the restriction of  $\leq_P$ , and assume that  $P/\sim$  has been given a partial order  $\leq$  in such a way that the horizontal and vertical maps in the (4.2) are also order-preserving.*

*Then the commutative diagram of associated simplicial maps of order complexes are all homotopy equivalences.*

PROOF. The proof is omitted for the sake of space. □

**Lemma 4.2.** *Given any subset  $D \subset [n - 1]$ , there exists a maximum element  $\tau(D)$  in  $(\mathfrak{S}_n, \leq_{weak})$  for the descent class*

$$Des_L^{-1}(D) := \{\sigma \in \mathfrak{S}_n : Des_L(\sigma) = D\}.$$

*Consequently, the map  $\mathfrak{S}_n \rightarrow \mathfrak{S}_n$  defined by  $\sigma \mapsto \tau(Des_L(\sigma))$  is a closure relation, with image isomorphic to  $(2^{[n-1]}, \subseteq)$ .*

PROOF. It is known that [3, page 98-100]  $Des_L^{-1}(D) := \{\sigma \in \mathfrak{S}_n : Des_L(\sigma) = D\}$  is actually an interval of the weak Bruhat order on  $S_n$ . The rest follows from this fact easily. □

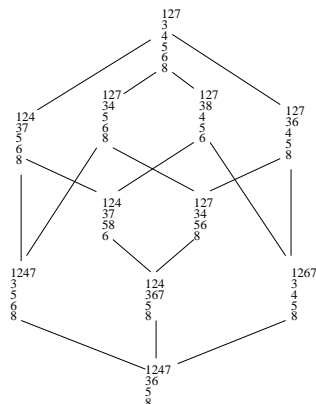

FIGURE 2. An interval in  $(SYT_8, \leq_{weak})$ , having Möbius function  $-2$ .

**Corollary 4.3.** Order  $\mathfrak{S}_n$  by  $\leq_{weak}$  and  $2^{[n-1]}$  by  $\subseteq$ , and let  $\leq$  be any order on  $SYT_n$  such that the commuting diagram (4.1) has all the maps order-preserving.

Then these restrict to a commuting diagram of order-preserving maps on the proper parts, each of which induces a homotopy equivalence of order complexes. Consequently,  $\mu(\hat{0}, \hat{1}) = (-1)^{n-1}$  for each of the three orders.

PROOF. Straightforward from Proposition 4.1 and Lemma 4.2, but omitted in this extended abstract.  $\square$

*Proof of Theorem 1.2.* Any partial order  $\leq$  on  $SYT_n$  between  $\leq_{weak}$  and  $\leq_{KL}^{op}$  satisfies the hypotheses of Corollary 4.3.  $\square$

The example shown in Figure 2 illustrates that the Möbius function values need not all lie in  $\{\pm 1, 0\}$  for  $\leq_{weak}$  on  $SYT_n$ .

**Remark 4.4.** In light of Theorems 1.2 and 3.4 one might ask if there are other natural orders on  $SYT_n$  which lie between  $\leq_{weak}$  and  $\leq_{KL}^{op}$ ? And if so, do any of them restrict to initial and final segments?

**Conjecture 4.5.** The Kazhdan-Lusztig order  $\leq_{KL}$  on  $SYT_n$  restricts to initial and final segments. Equivalently, the Kazhdan-Lusztig right pre-order on  $\mathfrak{S}_n$  restricts to initial and final segments.

By the evacuation symmetry on  $\leq_{KL}$  (see Proposition 2.6), one need only check that it restricts to initial segments. Computer calculations have verified this for  $SYT_n$  with  $n \leq 7$ .

**Remark 4.6.** One might ask to what extent the definitions and results in this paper apply to other Coxeter systems  $(W, S)$ . The weak order on  $W$  is well-defined, as are the  $KL$ -cells (replacing  $SYT_n$ ) and the  $KL$ -order, so Proposition 2.1, Definition 2.2 make sense and remain valid. Proposition 2.5 is also well-known ([9]; see [6, Fact 7]), and hence Proposition 2.6(i),(ii) remain valid.

For the analysis of Möbius function and homotopy types, the crucial Lemma 4.2 was proven by Bjorner and Wachs [4, Theorem 6.1] for all finite Coxeter groups  $W$ . Hence Corollary 4.3 and Theorem 1.2 are valid also in this generality, with the same proof.

### Acknowledgements

The author thanks A. Melnikov for allowing access to her unpublished preprints, and W. McGovern for helpful comments.



## References

- [1] M. Aguiar and F. Sottile, Structure of the Malvenuto-Reutenauer Hopf algebra of permutation, math.CO/0203282.
- [2] A. Björner, Topological Methods, *Handbook of Combinatorics*, (R. Graham, M. Gröschel and L. Lovász, eds.), Elsevier, Amsterdam, (1995), 1819-1872.
- [3] A. Björner, M. L. Wachs, Permutation Statistics and Linear Extensions of Posets, *J. Combin. Theory Ser. A*, **58**, no.1, (1991), 85-114.
- [4] A. Björner, M. L. Wachs, Generalized quotients in Coxeter groups. *Trans. Amer. Math. Soc.* **308** (1988), 1–37.
- [5] A. Björner, M. L. Wachs, Shellable nonpure complexes and posets, II. *Trans. Amer. Math. Soc.* **349** (1997), 3945–3975.
- [6] A. M. Garsia, T. J. McLarnan, Relations between Young’s Natural and the Kazhdan-Lusztig representation of  $S_n$ , *Adv. in Math.* **69** (1988), 32-92.
- [7] C. Greene, An extension of Schensted’s theorem, *Adv. in Math.*, **14** (1974), 254-265.
- [8] F. Hivert, J. Novelli, J. Thibon, Un analogue du monoïde paxique pour les arbres binaires de recherche, *C. R. Math. Acad. Sci.* **7** (2002), 577-580.
- [9] D. Kazhdan, G. Lusztig, Representations of Coxeter groups and Hecke algebras, *Invent. Math.*, **53** (1979), 165-184.
- [10] D. E. Knuth, *The art of computer programming* Vol.3, Addison-Wesley (1969), 49-72.
- [11] D. E. Knuth, Permutations, matrices and generalized Young tableaux, *Pacific J. Math.*, **34** (1970), 709-727.
- [12] J. Loday and M. Ronco, Hopf algebra of the planar binary trees, *Adv. in Math.* **139** (1998), 293-309.
- [13] J. Loday and M. Ronco, Order structure on the Algebra of Permutations and of Planar Binary Trees, *J. Algebraic Combin.*, **15** (2002), 253-270.
- [14] C. Malvenuto and C.Reutenauer, Duality between Quasi-Symmetric Functions and the Solomon Descent algebra, *J. Algebra*, **177** (1995), 967-982.
- [15] A. Melnikov, On orbital variety closures of  $\mathfrak{sl}_n$ , I. Induced Duflo order. math.RT/0311472. *J. Algebra*, to appear.
- [16] A. Melnikov, On orbital variety closures of  $\mathfrak{sl}_n$ , II. Descendants of a Richardson orbital variety. math.RT/0311474. *J. Algebra*, to appear.
- [17] S. Poirier et C. Reutenauer, Algèbres de Hopf de Tableaux, *Ann. Sci. Math. Québec*, **19**, (1995), no. 1, 79-90.
- [18] B.E. Sagan, *The Symmetric Group, Second edition*. Springer-Verlag, New York, Inc., (2001).
- [19] C. Schensted, Longest increasing subsequences, *Canad. J. Math.*, **13** (1961), 179-191.
- [20] M. P. Schützenberger, Quelques remarques sur une construction de Schensted, *Math. Scand.*, **12** (1963), 117-128.
- [21] M. P. Schützenberger, La correspondance de Robinson, *Combinatoire et Représentation du Groupe Symétrique*, Lecture Notes in Math.,**579**, Springer, Berlin (1977), 59-135.
- [22] R. P. Stanley, *Enumerative Combinatorics, Vol. 1*, Cambridge University Press, Cambridge, (1997).





## Deformed Universal Characters for Classical and Affine Algebras and the $X = M = K$ Conjecture

Mark Shimozono and Mike Zabrocki

**Abstract.** Creation operators are given for three distinguished bases of the type  $BCD$  universal character ring of Koike and Terada. Deformed versions of these operators create symmetric functions whose expansion in the universal character basis, has coefficient polynomials  $K \in \mathbb{Z}_{\geq 0}[q]$ . We conjecture that for every nonexceptional affine root system, these polynomials coincide with the graded tensor product multiplicities for affine characters that occur in the  $X = M$  conjecture of Hatayama, Kuniba, Okado, Takagi, Tsuboi, and Yamada, which asserts the equality of an affine crystal theoretic formula  $X$  with a rigged configuration fermionic formula  $M$ .

**Résumé.** Nous donnons les opérateurs qui créent trois bases spéciales du type  $BCD$  de l'anneau des caractères de Koike et Terada. Les versions déformées de ces opérateurs créent les fonctions symétriques avec les coefficients  $K \in \mathbb{Z}_{\geq 0}[q]$ . Nous conjecturons que pour tous les systèmes des racines affines et non-exceptionnels, ces polynômes coïncident avec les multiplicités des produit tensoriels des caractères affines qui apparaissent dans le conjecture  $X = M$  de Hatayama, Kuniba, Okado, Takagi, Tsuboi, et Yamada. Cette conjecture affirme qu'une formule pour  $X$  liée aux cristaux affines, est égale à une formule fermionique des configurations 'gréées' pour  $M$ .

### 1. Introduction

It is well-known that the ring  $\Lambda$  of symmetric functions is the universal character ring of type  $A$ , with universal characters given by the Schur functions. That is, for every  $n \in \mathbb{Z}_{>0}$  there is a ring epimorphism  $\Lambda \rightarrow R(GL(n))$  from  $\Lambda$  onto the ring of polynomial representations of  $GL(n)$ , which sends the Schur function  $s_\lambda$  to the isomorphism class of the irreducible  $GL(n)$ -module of highest weight  $\lambda$ .

Using identities of Littlewood [13], Koike and Terada [12] showed that that the common universal character ring for types  $B$ ,  $C$ , and  $D$ , is isomorphic to  $\Lambda$ , constructing two distinguished bases which correspond to the irreducible characters of the symplectic and orthogonal groups. These bases have the same structure constants under a suitable labeling of dominant weights by partitions. This ring captures the behavior (as the rank goes to infinity) of the representation ring of the simple Lie group, or more precisely, the subring generated by the vector representation.

There is a third basis of  $\Lambda$  with the same structure constants as the above two bases. This basis is implicitly defined by Kleber [7], who showed that up to a constraint involving Schur function expansions, these are the only three bases of  $\Lambda$  with the given set of structure constants. This basis also appears with

---

1991 *Mathematics Subject Classification.* Primary 05E10, 22E46.

*Key words and phrases.* symmetric functions, algebraic combinatorics, Kostka polynomials.

The first author is partially supported by NSF grant DMS-0100918.

a slight deformation in [11, def 6.4, eq (7.2.6)]. It is noteworthy that [7] was motivated by identities for characters of finite dimensional modules over affine algebras, and that one only sees the third basis upon considering the twisted affine root system  $D_{n+1}^{(2)}$ .

Bernstein’s creation operator  $B_r$  is a degree  $r$  linear endomorphism of  $\Lambda$ . The operators  $B_r$  create the Schur basis by adding a row at a time to a Schur function, in the sense that  $B_{\lambda_1} B_{\lambda_2} \cdots B_{\lambda_k} 1 = s_\lambda$  where  $\lambda = (\lambda_1, \dots, \lambda_k)$ . Jing [3] defined a  $q$ -analogue of Bernstein’s operator and showed that they create the Hall-Littlewood symmetric functions. In [22] the authors defined parabolic analogues of Jing’s Hall-Littlewood creation operators and showed that they create symmetric functions, which, when expanded in the Schur basis, have coefficients given by the generalized Kostka polynomials of [21].

We consider the analogous constructions for the three bases of the BCD universal character ring using the general  $q$ -analogue of a symmetric function operator given in [23]. Such operators create  $q$ -analogues of products of universal characters. In the row-adding case one obtains polynomials with nonnegative integer coefficients, but in the parabolic case the nonnegativity fails. Corresponding to the three bases of the BCD universal character ring, we define three analogues of the type  $A$  deformed parabolic creation operators, and observe that the coefficients are polynomials with nonnegative coefficients which we call  $K$ .

To identify the polynomials  $K$  we turn to affine algebras. Kirillov and Reshetikhin [8] defined a family of finite-dimensional modules over Yangians and conjectured that tensor products multiplicities of such modules, are given by a fermionic formula. This inspired Hatayama, Kuniba, Okado, Takagi, Tsuboi, and Y. Yamada [2] [1] to formulate the  $X = M$  conjecture. First, they conjecture the existence of a family of irreducible finite-dimensional modules over quantum affine algebras called Kirillov-Reshetikhin (KR) modules. Using the theory of affine crystal graphs, they define a formula  $X$ , which is a  $q$ -analogue of the multiplicities of the restriction to the canonical simple Lie subalgebra, of the tensor product of KR modules. They also define the fermionic formula  $M$  by generalizing to any affine root system, the  $q$ -analogue of the fermionic formula in [8]. They then assert that  $X = M$ .

We observe that for each infinite family of affine root systems, the formula  $M$  has a stable limit as the rank goes to infinity. Using the stable  $M$  polynomials we define a symmetric function called a universal affine character, which corresponds to the character of a tensor product of KR modules for large rank. We conjecture that  $X = M = K$ . There are eight infinite families of affine root systems if one distinguishes the two ways to achieve  $A_{2n}^{(2)}$  based on whether the 0 root is short (denoted  $A_{2n}^{(2)}$ ) or extra long (written  $A_{2n}^{(2)\dagger}$ ). In this stable limit we observe that there are only four distinct families of universal affine characters, which are in natural correspondence with the four bases of symmetric functions given by the Schur functions and the three other aforementioned bases. For any of the four families, the corresponding  $K$  polynomials are related to those of type  $A$  in a simple way. Moreover the  $K$  polynomials satisfy a Macdonald-type level-rank duality. Via the  $X = M = K$  conjecture these observations have remarkable implications for the affine characters.

## 2. Plethystic formulae

Let  $\Lambda$  be the ring of symmetric functions, to which we apply the ‘plethystic notation’. Instead of defining this notation precisely, we list most of the necessary identities in this section; see also subsection 3.3. Assume that the letters  $X, Y, Z$  and  $W$  represent sums of monomials with coefficient 1 and expressions like  $x \in X$  indicate that  $x$  is a single monomial in the multiset  $X$ . Let  $\widehat{\Lambda}$  be the completion of  $\Lambda$  given by formal sums  $f_0 + f_1 + f_2 + \dots$  where  $f_i \in \Lambda$  has degree  $i$ .

**2.1. Cauchy kernel.** There is an element  $\Omega \in \widehat{\Lambda}$  defined by

$$(2.1) \quad \Omega[X - Y] = \frac{\prod_{y \in Y} (1 - y)}{\prod_{x \in X} (1 - x)} = \left( \sum_{r \geq 0} (-1)^r s_{(1^r)}[Y] \right) \left( \sum_{r \geq 0} s_r[X] \right).$$

It satisfies  $\Omega[X + Y] = \Omega[X]\Omega[Y]$ . The reproducing kernel for  $\langle \cdot, \cdot \rangle$  is

$$(2.2) \quad \Omega[XY] = \sum_{\lambda} s_{\lambda}[X]s_{\lambda}[Y].$$

**2.2. Skewing operators.** Given  $P[X] \in \Lambda$ , the skewing operator  $P[X]^{\perp} \in \text{End}(\Lambda)$  is the linear operator that is adjoint to multiplication by  $P[X]$ :

$$(2.3) \quad P[X]^{\perp}(\Omega[XY]) = \Omega[XY]P[Y].$$

By linearity it follows that for all  $P[X] \in \Lambda$ ,

$$(2.4) \quad \Omega[XZ]^{\perp}(P[X]) = P[X + Z]$$

For all  $P[X] \in \Lambda$  one obtains the operator identity

$$(2.5) \quad \Omega[XW]^{\perp} \circ P[X] = P[X + W] \circ \Omega[XW]^{\perp}$$

where  $P[X]$  denotes multiplication by  $P[X] \in \Lambda$ .

**2.3. Coproduct.** The coproduct  $\Delta : \Lambda \rightarrow \Lambda \otimes \Lambda$  may be computed as follows. For  $P \in \Lambda$ , expand  $P[X + Y]$  as a sum of products of the form  $P_1[X]P_2[Y]$ :  $P[X + Y] = \sum_{(P)} P_1[X]P_2[Y]$ . Then  $\Delta(P) = \sum_{(P)} P_1 \otimes P_2$ .

The skewing operators  $P^{\perp}$  act on products via the coproduct:

$$(2.6) \quad P^{\perp}(QR) = \sum_{(P)} P_1^{\perp}(Q)P_2^{\perp}(R).$$

**2.4. Deforming an operator on  $\Lambda$ .** Given any operator  $V \in \text{End}(\Lambda)$ , one of the authors [23] defined its  $t$ -analogue  $\tilde{V} \in \text{End}(\Lambda)$  by

$$(2.7) \quad \tilde{V}(P[X]) = V^Y(P[tX + (1-t)Y])|_{Y \rightarrow X}$$

where  $V^Y$  acts on the  $Y$  variables and  $Y \rightarrow X$  is the substitution map. Applying this construction to  $V = \Omega[XZ] \circ \Omega[XW]^{\perp}$ , we have that for  $P[X] \in \Lambda$ ,

$$\tilde{V}(P[X]) = \Omega[XZ]\Omega[XW(1-t)]^{\perp}P[X].$$

By linearity, for all  $P[X], Q[X] \in \Lambda$ , if  $V = P[X] \circ Q[X]^{\perp}$ , then

$$(2.8) \quad \tilde{V} = P[X] \circ Q[X(1-t)]^{\perp}.$$

At  $t = 0$  the operator  $V$  is recovered:

$$(2.9) \quad \tilde{V}|_{t=0} = P[X] \circ Q[X]^{\perp} = V.$$

At  $t = 1$ , the operator

$$(2.10) \quad \tilde{V}|_{t=1} = P[X]Q[0]$$

is multiplication by  $P[X]Q[0]$ .

Let  $e_r[X] = s_{(1^r)}[X]$  be the elementary symmetric function. The following result is used in later proofs.

**Proposition 2.1.**

$$(2.11) \quad \Omega[W e_2[X]]^{\perp} \circ \Omega[Z X] = \Omega[Z X + W e_2[Z]]\Omega[W(e_2[X] + Z X)]^{\perp}.$$

### 3. Four bases of symmetric functions

**3.1. Littlewood’s formulae.** Let

$$(3.1) \quad \begin{aligned} f_{\emptyset}[X] &= 0 \\ f_{\square}[X] &= s_1[X] + e_2[X] \\ f_{\square\square}[X] &= e_2[X] \\ f_{\square\square\square}[X] &= s_2[X]. \end{aligned}$$

To explain the notation, for  $\diamond \in \{\emptyset, \square, \square\square, \square\square\square\}$ , let  $\mathcal{P}^\diamond$  be the set of partitions that can be tiled using the shape  $\diamond$ . That is,  $\mathcal{P}^\emptyset = \{\emptyset\}$  is the singleton set containing the empty partition,  $\mathcal{P} = \mathcal{P}^\square$  is the set of all partitions,  $\mathcal{P}^{\square\square}$  is the set of partitions with even rows, and  $\mathcal{P}^{\square\square\square}$  is the set of partitions with even columns. Littlewood proved that

$$(3.2) \quad \Omega[f_\diamond] = \sum_{\lambda \in \mathcal{P}^\diamond} s_\lambda[X].$$

**3.2. Definition of the four bases.** For  $\lambda \in \mathcal{P}$  define

$$(3.3) \quad s_\lambda^\diamond[X] = \Omega[-f_\diamond]^\perp s_\lambda[X].$$

All of the four families  $\{s_\lambda^\diamond \mid \lambda \in \mathcal{P}\}$  are bases of  $\Lambda$ , due to the inverse formula

$$(3.4) \quad s_\lambda[X] = \Omega[f_\diamond]^\perp s_\lambda^\diamond[X].$$

Of course  $s_\lambda^\emptyset = s_\lambda$  is the basis of Schur functions, which are the universal characters for the special/general linear groups. The bases  $\{s_\lambda^{\square\square}\}$  and  $\{s_\lambda^{\square\square\square}\}$  appear in [12] as the universal characters for the symplectic and orthogonal groups respectively. The basis  $\{s_\lambda^{\square}\}$  is not mentioned in [12] but appears implicitly in [7].

**Example 3.1.** The following elements may be computed by the Littlewood-Richardson rule, (3.3), and Littlewood’s inverse relations to (3.3) [15]. Each Schur function  $s_\mu$  will be represented by the Ferrers diagram of the partition  $\mu$ .

$$(3.5) \quad \begin{aligned} s_{(433)}^{\square\square} &= \begin{array}{c} \begin{array}{|c|c|c|} \hline \square & \square & \square \\ \hline \square & \square & \square \\ \hline \square & \square & \square \\ \hline \end{array} - \begin{array}{|c|c|c|} \hline \square & \square & \square \\ \hline \square & \square & \square \\ \hline \square & \square & \square \\ \hline \end{array} - \begin{array}{|c|c|c|} \hline \square & \square & \square \\ \hline \square & \square & \square \\ \hline \square & \square & \square \\ \hline \end{array} + \begin{array}{|c|c|c|} \hline \square & \square & \square \\ \hline \square & \square & \square \\ \hline \square & \square & \square \\ \hline \end{array} + \begin{array}{|c|c|c|} \hline \square & \square & \square \\ \hline \square & \square & \square \\ \hline \square & \square & \square \\ \hline \end{array} + \begin{array}{|c|c|c|} \hline \square & \square & \square \\ \hline \square & \square & \square \\ \hline \square & \square & \square \\ \hline \end{array} \\ & - \begin{array}{|c|c|c|} \hline \square & \square & \square \\ \hline \square & \square & \square \\ \hline \square & \square & \square \\ \hline \end{array} - \begin{array}{|c|c|c|} \hline \square & \square & \square \\ \hline \square & \square & \square \\ \hline \square & \square & \square \\ \hline \end{array} - \begin{array}{|c|c|c|} \hline \square & \square & \square \\ \hline \square & \square & \square \\ \hline \square & \square & \square \\ \hline \end{array} + \begin{array}{|c|c|c|} \hline \square & \square & \square \\ \hline \square & \square & \square \\ \hline \square & \square & \square \\ \hline \end{array} \\ s_{(433)}^{\square} &= \begin{array}{c} \begin{array}{|c|c|c|} \hline \square & \square & \square \\ \hline \square & \square & \square \\ \hline \square & \square & \square \\ \hline \end{array} - \begin{array}{|c|c|c|} \hline \square & \square & \square \\ \hline \square & \square & \square \\ \hline \square & \square & \square \\ \hline \end{array} - \begin{array}{|c|c|c|} \hline \square & \square & \square \\ \hline \square & \square & \square \\ \hline \square & \square & \square \\ \hline \end{array} + \begin{array}{|c|c|c|} \hline \square & \square & \square \\ \hline \square & \square & \square \\ \hline \square & \square & \square \\ \hline \end{array} + \begin{array}{|c|c|c|} \hline \square & \square & \square \\ \hline \square & \square & \square \\ \hline \square & \square & \square \\ \hline \end{array} - \begin{array}{|c|c|c|} \hline \square & \square & \square \\ \hline \square & \square & \square \\ \hline \square & \square & \square \\ \hline \end{array} \\ s_{(433)}^{\square\square\square} &= \begin{array}{c} \begin{array}{|c|c|c|} \hline \square & \square & \square \\ \hline \square & \square & \square \\ \hline \square & \square & \square \\ \hline \end{array} - \begin{array}{|c|c|c|} \hline \square & \square & \square \\ \hline \square & \square & \square \\ \hline \square & \square & \square \\ \hline \end{array} - \begin{array}{|c|c|c|} \hline \square & \square & \square \\ \hline \square & \square & \square \\ \hline \square & \square & \square \\ \hline \end{array} + \begin{array}{|c|c|c|} \hline \square & \square & \square \\ \hline \square & \square & \square \\ \hline \square & \square & \square \\ \hline \end{array} + \begin{array}{|c|c|c|} \hline \square & \square & \square \\ \hline \square & \square & \square \\ \hline \square & \square & \square \\ \hline \end{array} + \begin{array}{|c|c|c|} \hline \square & \square & \square \\ \hline \square & \square & \square \\ \hline \square & \square & \square \\ \hline \end{array} - \begin{array}{|c|c|c|} \hline \square & \square & \square \\ \hline \square & \square & \square \\ \hline \square & \square & \square \\ \hline \end{array} - \begin{array}{|c|c|c|} \hline \square & \square & \square \\ \hline \square & \square & \square \\ \hline \square & \square & \square \\ \hline \end{array} \\ & - \begin{array}{|c|c|c|} \hline \square & \square & \square \\ \hline \square & \square & \square \\ \hline \square & \square & \square \\ \hline \end{array} - \begin{array}{|c|c|c|} \hline \square & \square & \square \\ \hline \square & \square & \square \\ \hline \square & \square & \square \\ \hline \end{array} + \begin{array}{|c|c|c|} \hline \square & \square & \square \\ \hline \square & \square & \square \\ \hline \square & \square & \square \\ \hline \end{array} + \begin{array}{|c|c|c|} \hline \square & \square & \square \\ \hline \square & \square & \square \\ \hline \square & \square & \square \\ \hline \end{array} - \begin{array}{|c|c|c|} \hline \square & \square & \square \\ \hline \square & \square & \square \\ \hline \square & \square & \square \\ \hline \end{array} - \begin{array}{|c|c|c|} \hline \square & \square & \square \\ \hline \square & \square & \square \\ \hline \square & \square & \square \\ \hline \end{array} + \begin{array}{|c|c|c|} \hline \square & \square & \square \\ \hline \square & \square & \square \\ \hline \square & \square & \square \\ \hline \end{array} \end{array}$$

**3.3. Change of basis.** In plethystic formulae let  $\varepsilon$  represent a variable that has been specialized to the scalar  $-1$ . We will consider  $\varepsilon$  to be a special element with the property  $\varepsilon^2 = 1$  and

$$(3.6) \quad \Omega[\varepsilon X - \varepsilon Y] = \frac{\prod_{y \in Y} (1 + y)}{\prod_{x \in X} (1 + x)}.$$

For  $\diamond, \heartsuit \in \{\emptyset, \square, \square\square, \square\square\square\}$  define the linear isomorphism  $i_\diamond^\heartsuit : \Lambda \rightarrow \Lambda$  by

$$(3.7) \quad i_\diamond^\heartsuit(s_\lambda^\diamond[X]) = s_\lambda^\heartsuit[X]$$

for all  $\lambda$ . It is given by

$$(3.8) \quad i_\diamond^\heartsuit = \Omega[f_\diamond - f_\heartsuit]^\perp.$$

**Proposition 3.2.** For all  $P \in \Lambda$ ,

$$(3.9) \quad i_{\square} P[X] = P[X - 1] \quad i_{\square} P[X] = P[X + 1]$$

$$(3.10) \quad i_{\square} P[X] = P[X - 1 - \varepsilon] \quad i_{\square} P[X] = P[X + 1 + \varepsilon]$$

$$(3.11) \quad i_{\square} P[X] = P[X - \varepsilon] \quad i_{\square} P[X] = P[X + \varepsilon]$$

Since substitution maps are algebra homomorphisms, one has the following result, which was obtained in [12] for  $\square$  and  $\square$ . The full result is proved in [7], although the basis  $s_{\square}^{\lambda}[X]$  is not explicitly mentioned.

**Corollary 3.3.**  $i_{\diamond}^{\heartsuit}$  is an algebra isomorphism for  $\diamond, \heartsuit \in \{\square, \square, \square\}$ .

**3.4. BCD structure constants and uniqueness of bases.** Define the structure constants  ${}^{\diamond}c_{\mu\nu}^{\lambda}$  by

$$(3.12) \quad s_{\mu}^{\diamond}[X]s_{\nu}^{\diamond}[X] = \sum_{\lambda} {}^{\diamond}c_{\mu\nu}^{\lambda} s_{\lambda}^{\diamond}[X].$$

The coefficient  ${}^{\diamond}c_{\mu\nu}^{\lambda}$  is the ordinary Littlewood-Richardson coefficient  $c_{\mu\nu}^{\lambda}$ . By Corollary 3.3, the other three sets of structure constants coincide; call this common structure constant  $d_{\lambda\mu\nu}$ .

**Theorem 3.4.** [7] Suppose  $\{v_{\lambda}\}$  is a basis of  $\Lambda$  such that

$$(3.13) \quad v_{\mu}v_{\nu} = \sum_{\lambda} d_{\lambda\mu\nu} v_{\lambda}$$

for all  $\mu, \nu$  and that

$$(3.14) \quad s_{\lambda} \in v_{\lambda} + \sum_{\mu < \lambda} \mathbb{Z}_{\geq 0} v_{\mu}$$

where  $\mu \leq \lambda$  means that  $\mu_1 + \dots + \mu_i \leq \lambda_1 + \dots + \lambda_i$  for all  $i$  (but  $\mu$  and  $\lambda$  need not have the same number of cells). Then  $\{v_{\lambda}\}$  must be one of the bases  $\{s_{\square}^{\lambda}\}$ ,  $\{s_{\square}^{\lambda}\}$ , or  $\{s_{\square}^{\lambda}\}$ .

The structure constants  $d_{\lambda\mu\nu}$  can be expressed in terms of the Littlewood-Richardson coefficients  $c_{\mu\nu}^{\lambda}$  using the Newell-Littlewood formula.

**Proposition 3.5.** [14] [16]

$$(3.15) \quad d_{\lambda\mu\nu} = \sum_{\rho, \sigma, \tau} c_{\rho\tau}^{\mu} c_{\sigma\tau}^{\nu} c_{\rho\sigma}^{\lambda}.$$

**Example 3.6.** For  $\diamond \in \{\square, \square, \square\}$ ,

$$s_{(21)}^{\diamond} s_{(3)}^{\diamond} = s_{(2)}^{\diamond} + s_{(11)}^{\diamond} + s_{(4)}^{\diamond} + 2s_{(31)}^{\diamond} + s_{(22)}^{\diamond} + s_{(211)}^{\diamond} + s_{(51)}^{\diamond} + s_{(42)}^{\diamond} + s_{(411)}^{\diamond} + s_{(321)}^{\diamond}$$

The well-known transpose symmetry of Littlewood-Richardson coefficients  $c_{\mu^t \nu^t}^{\lambda} = c_{\mu\nu}^{\lambda}$  immediately implies the following result.

**Corollary 3.7.** [12]  $d_{\lambda^t \mu^t \nu^t} = d_{\lambda\mu\nu}$ .

### 4. Bernstein operators for the bases $s_{\square}^{\lambda}$ and determinants

**4.1. The Schur basis.** The Schur functions  $\{s_{\lambda} \mid \lambda \in \mathcal{P}\}$  are the unique family of symmetric functions, which for  $\lambda = (r)$  are given by

$$(4.1) \quad \sum_{r \in \mathbb{Z}} s_r[X] z^r = \Omega[zX]$$

and for  $\lambda \in \mathcal{P}$  are given by the Jacobi-Trudi determinant

$$(4.2) \quad s_{\lambda}[X] = \det |s_{\lambda_i - i + j}[X]|_{1 \leq i, j \leq \ell(\lambda)}$$

where  $\ell(\lambda)$  is the number of parts of  $\lambda$ . One may define  $s_\nu[X]$  for  $\nu \in \mathbb{Z}^n$  using (4.1) and (4.2).

Bernstein's operators  $\{B_r \mid r \in \mathbb{Z}\} \subset \text{End}(\Lambda)$  are defined by

$$(4.3) \quad B(z) = \sum_{r \in \mathbb{Z}} B_r z^r = \Omega[zX] \Omega[-z^*X]^\perp$$

where  $z^* = 1/z$ . For  $\nu \in \mathbb{Z}^n$ , define

$$B_\nu = B_{\nu_1} \circ B_{\nu_2} \circ \cdots \circ B_{\nu_n} \in \text{End}(\Lambda).$$

It is well-known that

$$(4.4) \quad B_\nu 1 = s_\nu[X].$$

**4.2. Creating the bases  $s^\diamond$ .** For  $\nu \in \mathbb{Z}^n$  and  $Z = (z_1, z_2, \dots, z_n)$ , define  $B_\nu^\diamond \in \text{End}(\Lambda)$  by

$$(4.5) \quad B^\diamond(Z) = \sum_{\nu \in \mathbb{Z}^n} z^\nu B_\nu^\diamond = i_\emptyset^\diamond \circ B(Z) \circ i_\emptyset^\diamond.$$

For  $\nu \in \mathbb{Z}^n$  it follows from (4.4) and (3.7) that

$$(4.6) \quad B_{\nu_1}^\diamond \cdots B_{\nu_n}^\diamond 1 = B_\nu^\diamond 1 = s_\nu^\diamond[X].$$

The operator  $B^\diamond(Z)$  has the following plethystic formula.

**Proposition 4.1.** For  $\diamond \in \{\square, \boxplus, \boxminus\}$ ,

$$(4.7) \quad B^\diamond(Z) = R(Z) \Omega[-f_\diamond[Z]] \Omega[ZX] \Omega[-(Z + Z^*)X]^\perp,$$

where  $Z^* = z_1^* + z_2^* + \cdots + z_n^*$  and

$$R(Z) = \prod_{1 \leq i < j \leq n} (1 - z_j/z_i).$$

It follows that

$$(4.8) \quad B^\square(Z) = \Omega[-Z] B^\boxplus(Z)$$

$$(4.9) \quad B^{\boxminus}(Z) = \Omega[-(1 + \varepsilon)Z] B^\boxplus(Z)$$

**4.3. Determinantal formulae.** Recall that the Schur functions satisfy the Jacobi-Trudi identity (4.2).

The other three bases satisfy a common determinantal formula due to Weyl for  $s^\boxplus$  and  $s^{\boxminus}$ . See [12, Thm. 2.3.3].

**Proposition 4.2.** For  $\diamond \in \{\square, \boxplus, \boxminus\}$  the basis  $\{s_\lambda^\diamond \mid \lambda \in \mathcal{P}\}$  of  $\Lambda$  is characterized by

$$(4.10) \quad \begin{aligned} s_r^\square &= s_r \\ s_r^\boxplus &= s_r - s_{r-1} \\ s_r^{\boxminus} &= s_r - s_{r-2} \end{aligned}$$

for  $r \in \mathbb{Z}$  and

$$(4.11) \quad s_\lambda^\diamond = \frac{1}{2} \det \left| s_{\lambda_i - i + j}^\diamond + s_{\lambda_i - i - j + 2}^\diamond \right|_{1 \leq i, j \leq \ell(\lambda)}$$



5. Hall-Littlewood symmetric functions and analogues

5.1. Deformed Schur basis. Define

$$(5.1) \quad \tilde{B}(Z) = \sum_{\nu \in \mathbb{Z}^n} z^\nu \tilde{B}_\nu$$

where  $\tilde{B}_\nu$  is the  $t$ -analogue of  $B_\nu$  given by equation (2.7). This is the “parabolic modified” analogue of Jing’s Hall-Littlewood creation operator. It was studied in [22], where it is denoted by  $H_\nu^t$ . It is given by

$$(5.2) \quad \tilde{B}(Z) = R(Z)\Omega[ZX]\Omega[(t-1)Z^*X]^\perp.$$

Let  $Z^{(1)}, \dots, Z^{(L)}$  be a family of finite ordered alphabets and  $R_1$  through  $R_L$  partitions such that the number of parts of  $R_j$  is equal to the number of letters in  $Z^{(j)}$  for all  $j$ . Define the symmetric functions  $\mathbb{B}_R[X; t]$  and polynomials  $c_{\lambda; R}(t)$  by

$$(5.3) \quad \tilde{B}_{R_1} \cdots \tilde{B}_{R_L} 1 = \mathbb{B}_R[X; t] = \sum_{\lambda} s_{\lambda}[X] c_{\lambda; R}(t).$$

The  $c_{\lambda; R}(t)$  are the generalized Kostka polynomials of [21], as proved in [22].

By (2.9) and (4.4) we have

$$(5.4) \quad \mathbb{B}_R[X; 0] = B_{R_1} \cdots B_{R_L} 1 = s_{(R_1, \dots, R_L)}[X]$$

where  $(R_1, \dots, R_L)$  denotes the sequence of integers obtained by juxtaposing the parts of the partitions  $R_j$ . By (2.10) and (4.4) we have

$$(5.5) \quad \mathbb{B}_R[X; 1] = s_{R_1}[X] \cdots s_{R_L}[X].$$

5.2. Deformed  $s_{\lambda}^{\diamond}$  basis. Let  $\tilde{B}_{\nu}^{\diamond}$  be the  $t$ -analogue of  $B_{\nu}^{\diamond}$ . For  $\diamond \in \{\square, \boxplus, \boxminus\}$  define

$$(5.6) \quad \tilde{B}^{\diamond}(Z) = \sum_{\nu \in \mathbb{Z}^n} z^\nu \tilde{B}_{\nu}^{\diamond}.$$

By (2.8), Proposition 4.1, (4.8) and (4.9),

$$(5.7) \quad \begin{aligned} \tilde{B}^{\square}(Z) &= R(Z)\Omega[-e_2[Z]]\Omega[ZX]\Omega[(Z+Z^*)(t-1)X]^\perp \\ \tilde{B}^{\boxplus}(Z) &= \tilde{B}^{\square}(Z)\Omega[-Z] \\ \tilde{B}^{\boxminus}(Z) &= \tilde{B}^{\square}(Z)\Omega[-(1+\varepsilon)Z]. \end{aligned}$$

For a sequence of partitions  $R = (R_1, R_2, \dots, R_L)$ , define the symmetric function  $\mathbb{B}_R^{\diamond}[X; t]$  and the polynomials  $d_{\lambda R}^{\diamond}(t)$  by

$$(5.8) \quad \mathbb{B}_R^{\diamond}[X; t] = \tilde{B}_{R_1}^{\diamond} \tilde{B}_{R_2}^{\diamond} \cdots \tilde{B}_{R_L}^{\diamond} 1 = \sum_{\lambda} d_{\lambda R}^{\diamond}(t) s_{\lambda}^{\diamond}.$$

**Theorem 5.1.**  $d_{\lambda R}^{\diamond}(t)$  is constant over  $\diamond \in \{\square, \boxplus, \boxminus\}$ .

Let us call these polynomials  $d_{\lambda R}(t)$ . When  $R$  consists of single-rowed rectangles of sizes given by the partition  $\mu$ , write  $d_{\lambda \mu}(t)$  instead of  $d_{\lambda R}(t)$ .

**Theorem 5.2.**  $d_{\lambda \mu}(t) \in \mathbb{Z}_{\geq 0}[t]$ .

**Example 5.3.** Let  $\mu = (3, 2, 1)$ . For  $\diamond \in \{\square, \blacksquare, \square\square\}$ , we will represent the function  $s_\lambda^\diamond$  by the diagram for the partition  $\lambda$  superscripted by  $\diamond$ . By Theorem 5.1 the expansion is independent of  $\diamond$ .

$$\begin{aligned} \mathbb{B}_\mu^\diamond[X; t] &= \begin{array}{c} \square\square\square^\diamond + t\square\square^\diamond + t\square\square\square^\diamond + (t^2 + t)\square\square\square^\diamond + (t^2 + t^3)\square\square\square\square^\diamond \\ + t^4\square\square\square\square^\diamond + (t^2 + t)\square\square^\diamond + t\square\square^\diamond + (2t^2 + t + t^3)\square\square^\diamond \\ + (t^4 + t^2 + t^3)\square\square\square^\diamond + (t^2 + t^3)\blacksquare^\diamond + (t^4 + t^2 + t^3)\square\square^\diamond + t^4\emptyset^\diamond \end{array} \end{aligned}$$

**6. Parabolic Hall-Littlewood operators and  $\diamond$ -analogues**

For each  $\diamond \in \{\emptyset, \square, \blacksquare, \square\square\}$  we define a variant of the type  $A$  parabolic Hall-Littlewood creation operator  $\tilde{B}_\nu$ . These will be the creation operators for the universal affine characters.

**6.1.  $\diamond$ -analogues of  $\tilde{B}_\nu$ .** Write  $\tilde{B}_{t^2}^\diamond(Z)$  for  $\tilde{B}^\diamond(Z)$  with  $t$  replaced by  $t^2$ . Let

$$(6.1) \quad H^\diamond(Z) = \sum_{\nu \in \mathbb{Z}^k} z^\nu H_\nu^\diamond = \Omega[f_\diamond[tX] - f_\diamond[X]]^\perp \tilde{B}_{t^2}^\diamond(Z) \Omega[f_\diamond[X] - f_\diamond[tX]]^\perp.$$

**Proposition 6.1.** For  $\diamond \in \{\emptyset, \square, \blacksquare, \square\square\}$ ,

$$(6.2) \quad H^\diamond(Z) = \Omega[f_\diamond[tZ]] \tilde{B}_{t^2}^\diamond(Z).$$

**6.2. The  $K$  polynomials.** Let  $R = (R_1, R_2, \dots, R_L)$  be a sequence of partitions. For  $\diamond \in \{\emptyset, \square, \blacksquare, \square\square\}$  define  $\mathbb{H}_R^\diamond[X; t]$  and  $K_{\lambda; R}^\diamond(t)$  by

$$(6.3) \quad \mathbb{H}_R^\diamond[X; t] = \sum_\lambda K_{\lambda; R}^\diamond(t) s_\lambda^\diamond[X] = H_{R_1}^\diamond H_{R_2}^\diamond \cdots H_{R_L}^\diamond 1.$$

Using (5.4) and (5.5) one obtains the specializations at  $t = 0$  and  $t = 1$ , for all  $\diamond$ .

$$(6.4) \quad \mathbb{H}_R^\diamond[X; 0] = s_{(R_1, R_2, \dots, R_L)}^\diamond[X]$$

$$(6.5) \quad \mathbb{H}_R^\diamond[X; 1] = s_{R_1}[X] s_{R_2}[X] \cdots s_{R_L}[X].$$

**Remark 6.2.** For any  $\diamond$ ,  $\mathbb{H}_R^\diamond[X; t]$  is a  $t$ -deformation of the product of Schur functions, rather than  $s_{R_i}^\diamond$ . Note also that  $K_{\lambda; R}^\emptyset(t) = c_{\lambda; R}(t^2)$ ; see (5.3).

**6.3.  $K^\diamond$  in terms of  $K^\emptyset$ .** Let  $|R| = \sum_i |R_i|$ . Observe that

$$\mathbb{H}_R^\diamond[X; t] = \Omega[f_\diamond[tX] - f_\diamond[X]]^\perp \mathbb{H}_R^\emptyset[X; t].$$

It follows that for  $\diamond \in \{\emptyset, \square, \blacksquare, \square\square\}$ ,

$$(6.6) \quad K_{\lambda; R}^\diamond(t) = t^{|R| - |\lambda|} \sum_{\substack{\tau \in \mathcal{P} \\ |\tau| = |R|}} K_{\tau; R}^\emptyset(t) \sum_{\substack{\mu \in \mathcal{P}^\diamond \\ |\mu| = |R| - |\lambda|}} c_{\lambda\mu}^\tau.$$

**Example 6.3.**

$$\begin{aligned}
 H_{(32)}^{\square\square}[X; t] &= s_{(32)}^{\square\square} + ts_{(41)}^{\square\square} + t^2s_{(5)}^{\square\square} + t^2(1+t+t^2)s_{(3)}^{\square\square} \\
 &\quad + t^2(1+t)s_{(21)}^{\square\square} + t^4(1+t+t^2)s_{(1)}^{\square\square} \\
 H_{(32)}^{\square}[X; t] &= s_{(32)}^{\square} + ts_{(41)}^{\square} + t^2s_{(5)}^{\square} + t^3s_{(3)}^{\square} + t^2s_{(21)}^{\square} + t^4s_{(1)}^{\square} \\
 H_{(32)}^{\square}[X; t] &= s_{(32)}^{\square} + ts_{(41)}^{\square} + t^2s_{(5)}^{\square} + ts_{(22)}^{\square} + (t+t^2)s_{(31)}^{\square} \\
 &\quad + (t^2+t^3)s_{(4)}^{\square} + (2t^2+t^3)s_{(21)}^{\square} + (t^2+2t^3+t^4)s_{(3)}^{\square} \\
 &\quad + t^3s_{(11)}^{\square} + (t^3+t^4)s_{(2)}^{\square} + t^4s_{(1)}^{\square}
 \end{aligned}$$

**6.4. Level-rank (transpose) duality.** Let  $\|R\| = \sum_{i < j} |R_i \cap R_j|$ ,  $\emptyset^t = \emptyset$ ,  $\square^t = \square$ ,  $\square^t = \square\square$ , and  $\square\square^t = \square$ .

**Proposition 6.4.** *Let  $R$  be a dominant sequence of rectangles (that is, one whose widths weakly decrease) and  $R'$  a dominant rearrangement of  $R^t$ . Then for all partitions  $\lambda$ ,*

$$(6.7) \quad K_{\lambda^t; R'}^{\diamond^t}(t) = t^{2(\|R\| + |R| - |\lambda|)} K_{\lambda; R}^{\diamond}(t^{-1}).$$

**6.5. Connection between  $\mathbb{B}^{\diamond}$  and  $\mathbb{H}^{\diamond}$ .**

**Proposition 6.5.** *Let  $R$  be the sequence of single-rowed partitions of sizes given by the partition  $\mu$ . Then*

$$(6.8) \quad \mathbb{H}_R^{\square}[X; t] = \mathbb{B}_R^{\square}[X; t^2]$$

$$(6.9) \quad K_{\lambda; R}^{\square}(t) = d_{\lambda R}(t^2).$$

**7. Universal affine characters and  $X = M = K$**

Let  $\mathfrak{g}$  be any affine Lie algebra, say, of type  $X_N^{(r)}$  [6], with canonical simple Lie subalgebra  $\overline{\mathfrak{g}}$  of rank  $n$ , and let  $U'_q(\mathfrak{g})$  and  $U_q(\overline{\mathfrak{g}})$  the corresponding quantized enveloping algebras. Motivated by the work of [8] on finite-dimensional modules over Yangians, the papers [2] and [1] conjecture the existence of finite-dimensional  $U'_q(\mathfrak{g})$ -modules called Kirillov-Reshetikhin (KR) modules. In type  $A$  the restriction of a KR module to  $U_q(\overline{\mathfrak{g}})$  has character given by a Schur function indexed by a rectangle. In general one can think of the KR-modules as being indexed by rectangles, but the restriction of a KR module to  $U_q(\overline{\mathfrak{g}})$  is generally reducible. The KR modules are conjectured to have a natural grading that is constant on  $U_q(\overline{\mathfrak{g}})$ -components.

The above two papers propose the  $X = M$  conjecture, which give two ways to compute the graded multiplicity of a  $U_q(\overline{\mathfrak{g}})$ -irreducible in a tensor product of KR modules over  $U'_q(\mathfrak{g})$ . The symbols  $X$  and  $M$  represent two families of polynomials that are indexed by a pair  $(R, \lambda)$  where  $R$  is a sequence of rectangles which corresponds to a tensor product of KR modules, and  $\lambda$  is a partition which corresponds to a dominant weight of  $\overline{\mathfrak{g}}$ . The  $X$  formula can be stated entirely in terms of the affine crystal graph of a tensor product of KR modules; its definition depends on the existence of KR modules and some of their conjectured properties. The  $M$  formula is a  $q$ -analogue of the fermionic formula in [8], but extended to all affine root systems. It is well-defined and independent of the existence of KR modules. See [2] and [1] for details on this remarkable conjecture.

The  $X = M$  conjecture is only completely proved for type  $A$  [10] and in this case the polynomials are essentially the generalized Kostka coefficients  $c_{\lambda; R}(t)$  of equation (5.3). In general the KR modules have not even been constructed, although strong additional hints on their structure have been provided by Kashiwara [4] [5].

**Proposition 7.1.** *Consider a nonexceptional family  $\{X_N^{(r)}\}$  of affine root systems. There is a well-defined limiting polynomial*

$$(7.1) \quad \lim_{n \rightarrow \infty} \overline{M}_{R,\lambda}(t)$$

as the rank  $n$  goes to infinity. It depends only on  $R$ ,  $\lambda$ , and the affine family of  $X_N^{(r)}$ . Moreover, there are only four distinct families of such polynomials, which shall be named as follows.

- (1) For  $A_n^{(1)}$ :  $\overline{M}_{R,\lambda}^\emptyset(t)$ .
- (2) For  $B_n^{(1)}$ ,  $D_n^{(1)}$ , and  $A_{2n-1}^{(2)}$ :  $\overline{M}_{R,\lambda}^\square(t)$ .
- (3) For  $C_n^{(1)}$  and  $A_{2n}^{(2)\dagger}$ :  $\overline{M}_{R,\lambda}^{\square\square}(t)$ .
- (4) For  $D_{n+1}^{(2)}$  and  $A_{2n}^{(2)}$ :  $\overline{M}_{R,\lambda}^{\square\square\square}(t)$ .

The families are grouped according to the decomposition of a KR module upon restriction to  $U_q(\overline{\mathfrak{g}})$ ; see the appendices of [2] [1]. We define the **universal affine character** associated to  $\diamond$  and  $R$  to be the symmetric function  $\sum_\lambda \overline{M}_{R,\lambda}^\diamond(t) s_\lambda^\diamond$ ; it corresponds to the graded character of the tensor product of KR modules indexed by  $R$  in the large rank limit.

**Conjecture 7.2.** *For  $R$  a dominant sequence of rectangles and all  $\diamond \in \{\emptyset, \square, \square\square, \square\square\square\}$ ,*

$$(7.2) \quad K_{\lambda;R}^\diamond(t) = \overline{M}_{R^t,\lambda^t}^{\diamond^t}(t^{2/\epsilon})$$

where  $\epsilon = 1$  except for  $\diamond = \square$ , in which case  $\epsilon = 2$ .

At  $t = 1$  this was essentially known [7]. However the formulae for the powers of  $t$  occurring in the affine characters given either by  $X$  or the  $M$  formulae, do not at all suggest such a simple relationship. Perhaps the virtual crystal methods of [17] can be used to prove Conjecture 7.2.

Equation (7.2) holds for  $\diamond = \emptyset$  by combining [10] [18] [19] [20] [22]. It also holds for a single rectangle in all nonexceptional affine types; see [1, Appendix A] and [2, Appendix A].

Observe that by combining Conjecture 7.2 and Proposition 6.4 one obtains the following conjecture.

**Conjecture 7.3.**

$$(7.3) \quad \overline{M}_{R;\lambda}^\diamond(t) = t^{\epsilon(|R|+|\lambda|-|\lambda|)} \overline{M}_{R^t,\lambda^t}^{\diamond^t}(t^{-1}).$$

This was proved in [9] via a direct bijection for  $\diamond = \emptyset$ . This is a striking conjecture as it relates the fermionic formulae of different types. This kind of relation is not apparent from the structure of the fermionic formulae.

### References

- [1] G. Hatayama, A. Kuniba, M. Okado, T. Takagi, and Z. Tsuboi, Paths, Crystals and Fermionic Formulae, MathPhys odyssey, 2001, 205–272, Prog. Math. Phys., **23**, Birkhäuser Boston, Boston, MA, 2002.
- [2] G. Hatayama, A. Kuniba, M. Okado, T. Takagi, and Y. Yamada, Remarks on fermionic formula, in Recent developments in quantum affine algebras and related topics (Raleigh, NC, 1998), 243–291, Contemp. Math., **248**, Amer. Math. Soc., Providence, RI, 1999.
- [3] N. Jing, Vertex operators and Hall-Littlewood symmetric functions. Adv. Math. **87** (1991) 226–248.
- [4] M. Kashiwara, On level-zero representation of quantized affine algebras, Duke Math. J. **112** (2002), 117–195.
- [5] M. Kashiwara, Level zero fundamental representations over quantized affine algebras and Demazure modules, preprint math.QA/0309142.
- [6] V. Kac, Infinite dimensional Lie algebras, 3rd ed., Cambridge University Press, 1990.
- [7] M. Kleber, Embeddings of Schur functions into types  $B/C/D$ , J. Algebra **247** (2002) 452–466.
- [8] A. N. Kirillov and N. Yu. Reshetikhin, Representations of Yangians and multiplicities of the inclusion of the irreducible components of the tensor product of representations of simple Lie algebras, J. Soviet Math. **52** (1990) 3156–3164.

- [9] A. N. Kirillov and M. Shimozono, A generalization of the Kostka-Foulkes polynomials, *J. Algebraic Combin.* **15** (2002) 27–69.
- [10] A. N. Kirillov, A. Schilling, and M. Shimozono, A bijection between Littlewood-Richardson tableaux and rigged configurations, *Selecta Math. (N.S.)* **8** (2002) 67–135.
- [11] K. Koike, Representations of spinor groups and the difference characters of  $SO(2n)$ , *Advances in Mathematics*, Vol. 128, 1997, pp.58–62
- [12] K. Koike and I. Terada, Young-diagrammatic methods for the representation theory of the classical groups of type  $B_n, C_n, D_n$ , *J. Algebra* **107** (1987) 466–511.
- [13] D. E. Littlewood, *The theory of group characters and matrix representation of groups*, second edition, Clarendon Press, Oxford, 1950.
- [14] D. E. Littlewood, *Canad. J. Math.* **10** (1958) 17–32.
- [15] I. G. Macdonald, *Symmetric functions and Hall polynomials*, 2nd ed., Oxford Mathematical Monographs, Oxford Science Publications, The Clarendon Press, Oxford University Press, New York, 1995.
- [16] M. J. Newell, *Proc. Roy. Irish Acad. Sect. A* **54** (1951) 153–163.
- [17] M. Okado, A. Schilling, and M. Shimozono, Virtual crystals and fermionic formulas for types  $D_{n+1}^{(2)}$ ,  $A_{2n}^{(2)}$ , and  $C_n^{(1)}$ , *Represent. Theory* **7** (2003), 101–163.
- [18] A. Schilling and S. O. Warnaar, Inhomogeneous lattice paths, generalized Kostka polynomials and  $A_{n-1}$  supernomials, *Comm. Math. Phys.* **202** (1999) 359–401.
- [19] M. Shimozono, A cyclage poset structure for Littlewood-Richardson tableaux, *European J. Combin.* **22** (2001) 365–393.
- [20] M. Shimozono, Affine Type A Crystal Structure on Tensor Products of Rectangles, Demazure characters, and Nilpotent Varieties, *J. Algebraic Combin.* **15** (2002) 151–187.
- [21] M. Shimozono and J. Weyman, Graded characters of modules supported in the closure of a nilpotent conjugacy class, *European J. Combin.* **21** (2000) 257–288.
- [22] M. Shimozono and M. Zabrocki, Hall-Littlewood vertex operators and generalized Kostka polynomials. *Adv. Math.* **158** (2001) 66–85.
- [23] M. Zabrocki, q-Analogs of symmetric function operators, *Disc. Math.* **256** (2002) 831–853.

DEPARTMENT OF MATHEMATICS, VIRGINIA TECH, BLACKSBURG, VA 24061-0123 USA  
*E-mail address:* mshimo@math.vt.edu

DEPT. OF MATH AND STATS, YORK UNIVERSITY, TORONTO, CANADA, M3J 1P3  
*E-mail address:* zabrocki@mathstat.yorku.ca





# Tamari Lattices and Non-crossing Partitions in Types $B$ and $D$

Hugh Thomas

**Abstract.** *The usual, or type  $A_n$ , Tamari lattice is a partial order on  $T_n^A$ , the triangulations of an  $(n + 3)$ -gon. We define a partial order on  $T_n^B$ , the set of centrally symmetric triangulations of a  $(2n + 2)$ -gon. We show that it is a lattice, and that it shares certain other nice properties of the  $A_n$  Tamari lattice; it can therefore be considered the  $B_n$  Tamari lattice.*

*We define a bijection between  $T_n^B$  and the non-crossing partitions of type  $B_n$  defined by Reiner. Reiner has also defined the noncrossing partitions of type  $D_n$  as a subset of those of type  $B_n$ . We show that the elements of  $T_n^B$  which correspond to the noncrossing partitions of type  $D_n$  form a lattice under the order induced from their inclusion in  $T_n^B$ , which therefore can be considered the  $D_n$  Tamari lattice.*

*This is a somewhat abridged version of a longer paper with the same title, available at [www.arxiv.org/math.CO/0311334](http://www.arxiv.org/math.CO/0311334).*

**Résumé.** *Le treillis de Tamari standard (de type  $A_n$ ) est un ordre partiel sur  $T_n^A$ , les triangulations d'un  $(n + 3)$ -gone. Nous définissons un ordre partiel sur  $T_n^B$ , l'ensemble des triangulations centralement symétriques d'un  $(2n + 2)$ -gone. Nous montrons que c'est un treillis et qu'il possède aussi d'autres propriétés intéressantes similaires au treillis de Tamari de type  $A_n$ . Ce treillis peut donc être considéré comme le treillis de Tamari de type  $B_n$ .*

*Nous définissons une bijection entre  $T_n^B$  et les partages non-croisés de type  $B_n$  définis par Reiner. Reiner a aussi défini les partages non-croisés de type  $D_n$  comme un sous-ensemble de ceux de type  $B_n$ . Nous montrons que les éléments de  $T_n^B$  qui correspondent aux partages non-croisés de type  $D_n$  forment un treillis sous l'ordre induit par leur inclusion dans  $T_n^B$ , qui peut donc être considéré comme le treillis de Tamari de type  $D_n$ .*

*Cet exposé est une version plus courte d'un exposé du même titre qui est disponible sur [www.arxiv.org/math.CO/0311334](http://www.arxiv.org/math.CO/0311334).*

## 1. Introduction

Let  $T_n^A$  denote the set of triangulations of an  $(n + 3)$ -gon. By a triangulation of a polygon, we mean a division of it into triangles by connecting pairs of its vertices with straight lines which do not cross in the interior of the polygon. Conventionally, we will number the vertices of our  $(n + 3)$ -gon clockwise from 0 to  $n + 2$ , with a long top edge connecting vertices 0 and  $n + 2$ . An example triangulation is shown in Figure 1 below.

Let  $S \in T_n^A$ . As in [Lee], we colour the chords of  $S$  red and green, as follows. A chord  $C$  of  $S$  is the diagonal of a quadrilateral  $Q(C)$  in  $S$ . If  $C$  is the diagonal of  $Q(C)$  which is connected to the vertex with

---

1991 *Mathematics Subject Classification.* Primary 05E15.

*Key words and phrases.* Tamari lattice, non-crossing partitions, classical types, left modularity, EL-labelling.

the largest label, we colour it green; otherwise we colour it red. In Figure 1, the red chords are indicated by thick lines.

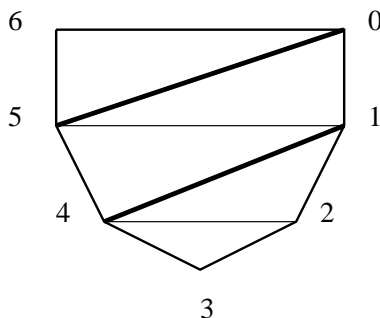

FIGURE 1

We partially order  $T_n^A$  by giving covering relations:  $T$  covers  $S$  if they coincide except that some green chord in  $S$  has been replaced by the other diagonal of  $Q(C)$  (which is red). This is one way to construct the Tamari lattice, which was introduced in [Tam] and which has since been studied by several authors (see [HT, Pal, BW2]).

Although this is not clear from the elementary description given here, the Tamari lattice should be thought of as being associated to type  $A$ . One indication of why can be found in [BW2], where it is shown that  $T_n^A$  is a quotient of the weak order on the symmetric group  $S_{n+1}$  (the type  $A_n$  reflection group). Another reason is that the elements of  $T_n^A$  index clusters in the  $A_n$  root system (see [FZ]). Once one has the idea that the Tamari lattice is type  $A$ , it is natural to ask whether there exist Tamari lattices in other types.

For reasons which we shall go into further below, the  $B_n$  triangulations, denoted  $T_n^B$ , are the triangulations of a  $(2n+2)$ -gon which are fixed under a half-turn rotation. These triangulations have already appeared in the work of Simion [Sim], and in that of Fomin and Zelevinsky [FZ] where they index the clusters in the  $B_n$  root system. One goal of our paper is to define a partial order on  $T_n^B$  and to prove that it is a lattice. The definition is analogous to that already given for the  $A_n$  Tamari lattice: it is given in terms of covering relations, and  $S$  covers  $T$  in  $T_n^B$  if  $S$  is obtained from  $T$  by replacing a symmetric pair of chords  $C, \bar{C}$  by the other diagonals of  $Q(C), Q(\bar{C})$ . The details of the definition are a trifle complicated, so we defer them for the main body of the paper. This definition was arrived at independently and more or less simultaneously by Reading [Rea]. He has also proved that  $T_n^B$  is a lattice, using a rather different approach. Two alternative partial orders on  $T_n^B$  with similar (but somewhat easier to describe) covering relations were suggested by Simion [Sim]; one is studied further in [San]. But since neither of these is a lattice, neither is completely satisfying as a type  $B$  analogue of the usual Tamari lattice.

What objects should be considered the  $D_n$  triangulations is not as settled as in type  $B_n$ , although certain information is known, such as the desired cardinality. One candidate is provided in [FZ], and used there to index the clusters in the  $D_n$  root system. We follow a different approach. First, we find a bijection between  $B_n$  triangulations and  $B_n$  non-crossing partitions, which were introduced by Reiner [Rei]. Motivated by Reiner's definition of non-crossing partitions for type  $D_n$  as a subset of those for type  $B_n$  (which has the desired cardinality), we take our  $D_n$  triangulations  $T_n^D$  to be the corresponding subset of  $T_n^B$ . (It is not clear whether there is any natural bijection between our  $T_n^D$  and the  $D_n$  triangulations of [FZ].) Our second chief result is to show that the order induced on  $T_n^D$  from its inclusion in  $T_n^B$  gives it a lattice structure also. In fact, our approach to type  $D_n$  works for any of the interpolating pseudo-types indexing hyperplane arrangements between  $B_n$  and  $D_n$ . (We shall recall the definition of these pseudo-types below.)

We show that  $T_n^B$  and  $T_n^D$  have an unrefinable chain of left modular elements, a property also shared by the usual Tamari lattice [BS]. One consequence of this, due to Liu [Liu], is that these lattices have



EL-labellings. Using these labellings, we show that, as for the usual Tamari lattice (see [BW2]), the order complex of any interval is either homotopic to a sphere or contractible.

From the results in this paper one could proceed in two directions. One direction is to consider the existence of Tamari lattices in all Coxeter types. The other direction is to investigate further the lattices defined here, to see how many more of the properties of the usual Tamari lattice carry over.

### 2. Type B Triangulations

Recall that the  $B_n$  Weyl group consists of signed permutations of  $n$ . We can think of these as permutations of  $\{1, \dots, n, \bar{1}, \dots, \bar{n}\}$  fixed under interchanging  $i$  and  $\bar{i}$  for all  $1 \leq i \leq n$ . By analogy,  $B_n$  triangulations,  $T_n^B$ , are defined to be type  $A$  triangulations of a  $(2n + 2)$ -gon fixed under a half-turn. There is general consensus that this is the correct definition of  $B_n$  triangulation: see [Sim, FZ].

We number the vertices of our standard  $(2n + 2)$ -gon counterclockwise from  $n + 1$  to 1 and then from  $\overline{n + 1}$  to  $\bar{1}$ . A typical triangulation is shown in Figure 2.

We will frequently distinguish two types of chords: *pure* and *mixed*. A chord is pure if it connects two barred vertices or two unbarred vertices; otherwise it is mixed. For  $S \in T_n^B$ , consider a chord  $C$  of  $S$ . The chord  $C$  is the diagonal of a quadrilateral, which we denote  $Q(C)$ . If  $C$  is pure, then we colour it red if  $Q(C)$  contains another vertex of the same type as those of  $C$  whose label is higher, and green otherwise. If it is mixed, we colour it red if  $Q(C)$  contains an unbarred vertex whose label is higher than the label of the unbarred vertex of  $C$ , or a barred vertex whose label is higher than the label of the barred vertex of  $C$ . Otherwise we colour it green. In Figure 2, the red chords are indicated by thick lines.

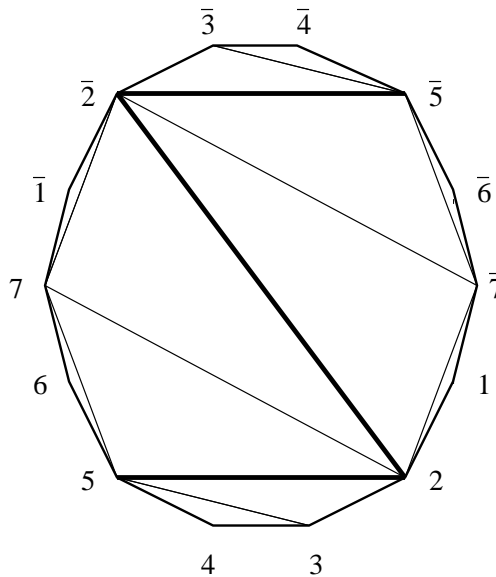

FIGURE 2

For  $C$  a chord, we write  $\bar{C}$  for its symmetric partner (that is to say, the image of  $C$  under a half turn). Observe that  $C$  and  $\bar{C}$  are assigned the same colour.

**Lemma 2.1.** *Consider a chord  $C$  in a triangulation  $S$ . Let  $S'$  be the triangulation obtained by replacing  $C$  by  $C'$ , the other diagonal of  $Q(C)$ , and also replacing  $\bar{C}$  by  $\bar{C}'$ . Then the colours of  $C$  in  $S$  and  $C'$  in  $S'$  are opposite.*

We can now state the first main theorem of this paper (which, as was already remarked, was arrived at and proved independently and more or less simultaneously by Reading [Rea]).

**Theorem 2.2.** *There is a lattice structure on  $T_n^B$  whose covering relations are given by  $S \leq T$  iff  $S$  and  $T$  differ in that green chords  $C, \bar{C}$  in  $S$  are replaced in  $T$  by the other diagonals of  $Q(C)$  and  $Q(\bar{C})$  (which will be red). Note that we allow  $C = \bar{C}$  (i.e.  $C$  being a diameter). We call this lattice the  $B_n$  Tamari lattice.*

The first ingredient in our proof of Theorem 1 is some further analysis of the red and green chords of triangulations.

Fix a triangulation  $S$ . For  $1 \leq i \leq n$ , consider those chords of  $S$  which are attached to  $i$  and let  $C_i(S)$  be the first of these encountered in searching clockwise starting at  $\bar{1}$ . If none is encountered before reaching  $i - 1$ , then  $C_i(S)$  is not defined. Let  $R(S)$  be the set of these chords, together with their symmetric partners.

**Lemma 2.3.** *For any triangulation  $S$ , the chords in  $R(S)$  are red, the other chords of  $S$  are green, and  $S$  is the unique triangulation whose red chords are exactly  $R(S)$ .*

### 3. Bracket Vectors in types A and B

We briefly recall some well-known facts about the type A Tamari lattice, which serve as motivation for our work in type B.

Any triangulation  $S \in T_n^A$  has a bracket vector  $r(S) = (r_1(S), \dots, r_{n+1}(S))$ . Let  $c_i(S)$  be the least vertex attached to  $i$ . Then  $r_i(S) = i - 1 - c_i(S)$ . For example, the bracket vector of the triangulation shown in Figure 1 is  $(0, 0, 0, 2, 4)$ . This approach to representing elements of the Tamari lattice goes back to [HT], though we make some different choices of convention here.

**Proposition 3.1.** *An  $(n + 1)$ -tuple of positive integers is a bracket vector for some triangulation in  $T_n^A$  iff it satisfies the following two properties:*

- (i) For  $1 \leq i < j \leq n + 1$ ,  $r_i \leq r_j - (j - i)$  provided  $r_j - (j - i)$  is non-negative.
- (ii)  $0 \leq r_i \leq i - 1$ .

The order relation on triangulations has a simple interpretation in terms of bracket vectors, which we summarize in the following proposition:

**Proposition 3.2.** *The lattice structure on  $T_n^A$  can be described as follows:*

- (i)  $S \leq T$  iff  $r_i(S) \leq r_i(T)$  for all  $i$ .
- (ii)  $r(S \wedge T)_i = \min(r_i(S), r_i(T))$ .

(iii) For  $x$  any  $n + 1$ -tuple of numbers satisfying only the second condition of Proposition 1, there is a unique triangulation  $\uparrow(x)$  such that for  $S \in T_n^A$ ,

$$r_i(S) \geq x_i \text{ for all } i \text{ iff } S \geq \uparrow(x).$$

- (iv)  $r(S \vee T) = \uparrow(\max(r(S), r(T)))$ , where  $\max$  is taken coordinatewise.

We now proceed to describe a similar construction in type B. To a triangulation  $S \in T_n^B$  we associate a bracket vector  $r(S) = (r_1(S), \dots, r_n(S))$ , as follows. For  $1 \leq i \leq n$ , let  $c_i(S)$  denote the first vertex adjacent to  $i$  encountered proceeding clockwise starting at  $\bar{1}$ . If the counter-clockwise distance from  $i - 1$  to  $c_i(S)$  is less than or equal to  $n - 1$ , set  $r_i(S)$  to be that distance. Otherwise, set  $r_i(S) = *$ . Thus, the triangulation shown in Figure 2 has bracket vector  $(0, *, 0, 0, 2, 0)$ .

**Conventions regarding  $*$ .**  $*$  is considered to be greater than any integer.  $*$  plus an integer (or  $*$ ) equals  $*$ .

**Lemma 3.3.** *The map from  $T_n^B$  to bracket vectors is injective.*

**Proposition 3.4.**  *$B_n$  bracket vectors are  $n$ -tuples of symbols from  $[0, n - 1] \cup \{*\}$  characterized by the following two properties:*

- i) For  $1 \leq i < j \leq n$ ,  $r_i \leq r_j - (j - i)$  if  $r_j - (j - i)$  is non-negative.

ii) If  $* > r_i \geq i$ , then  $r_{n+i-r_i} = *$ .

We will now define an order on  $T_n^B$ . For  $S, T \in T_n^B$ , let  $S \leq T$  iff for all  $i$ ,  $r_i(S) \leq r_i(T)$ .

**Proposition 3.5.** *The covering relations in this order on  $T_n^B$  are exactly those described by Theorem 1.*

Our next goal is to show that the  $B_n$  Tamari order is really a lattice. Before we can do that, we need some preliminary results.

Let  $M_n$  denote the  $n$ -tuples with entries in  $[0, n - 1] \cup \{*\}$ , with the Cartesian product order. Let  $M_n^{(i)}$  denote the elements of  $M_n$  which satisfy condition (i) of Proposition 3. Let  $M_n^{(ii)}$  denote the elements of  $M_n$  which satisfy condition (ii) of Proposition 3.

**Proposition 3.6.** *There exist maps  $\uparrow: M_n^{(ii)} \rightarrow T_n^B$ ,  $\downarrow: M_n^{(i)} \rightarrow T_n^B$ , which satisfy the following conditions:*

$$f \leq r(S) \text{ iff } \uparrow(f) \leq S$$

$$r(S) \leq f \text{ iff } S \leq \downarrow(f).$$

Using these maps, we can prove that meet and join exist in  $T_n^B$  by giving simple descriptions of them.

**Proposition 3.7.** *The Tamari order on  $T_n^B$  is a lattice. The lattice operations are as follows: For  $S, T \in T_n^B$ ,  $S \vee T = \uparrow(\max(r(S), r(T)))$  and  $S \wedge T = \downarrow(\min(r(S), r(T)))$ .*

This completes the proof of Theorem 1. The Hasse diagram of  $T_B^3$  is shown in Figure 5, at the end of the paper.

#### 4. Non-crossing partitions

The  $A_n$  non-crossing partitions,  $NC_n^A$ , are partitions of  $n + 1$  into sets such that if  $v_1, \dots, v_{n+1}$  are  $n + 1$  points on a circle, labelled in cyclic order, and if  $B_1, \dots, B_r$  are the convex hulls of the sets of vertices corresponding to the blocks of the partition, then the  $B_i$  are non-intersecting.

There is a bijection from  $T_n^A$  to  $NC_n^A$  as follows. For  $S \in T_n^A$ , erase all the green chords of  $S$  and the vertices 0 and  $n + 2$ . Then move the endpoints of each red chord  $ij$  a little bit, the lower-numbered end point a little clockwise, the higher-numbered endpoint a little counterclockwise (so  $i$  and  $j$  are both on the upper side of the chord). These chords now divide the vertices in  $[n + 1]$  into subsets, which form a non-crossing partition by construction. Figure 3 shows the triangulation from Figure 1, together with the non-crossing partition which it induces:  $\{14, 23, 5\}$

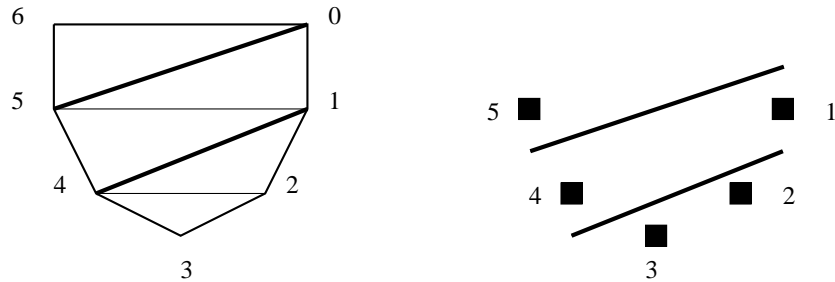

FIGURE 3

Note that the non-crossing partitions are often considered as being ordered by refinement; this order is quite different from the Tamari order.

As defined by Reiner [Rei], the  $B_n$  non-crossing partitions,  $NC_n^B$ , are partitions of the set  $1, \dots, n, \bar{1}, \dots, \bar{n}$ , which have the properties that the partition remains fixed under interchanging barred and unbarred elements, and that if  $2n$  points are chosen around a circle and labelled cyclically  $v_1, \dots, v_n, v_{\bar{1}}, \dots, v_{\bar{n}}$ , then the convex hulls of the vertices corresponding to the blocks of the partition do not intersect.

We now define a map  $\psi$  from  $T_n^B$  to  $NC_n^B$ , analogous to that in type A. Erase all green chords. Move both endpoints of mixed red chords slightly counterclockwise. Move the endpoints of pure red chords slightly together (so that the vertices both lie on the side of the chord which includes the larger part of the polygon). Erase the vertices  $n + 1$  and  $\overline{n + 1}$ . The remaining vertices are now partitioned by the red chords, in what is clearly a  $B_n$  non-crossing partition. Figure 4 shows the triangulation from Figure 2, together with the  $B_n$  non-crossing partition which it induces:  $\{\overline{1256}, 34, \overline{1256}, \overline{34}\}$ .

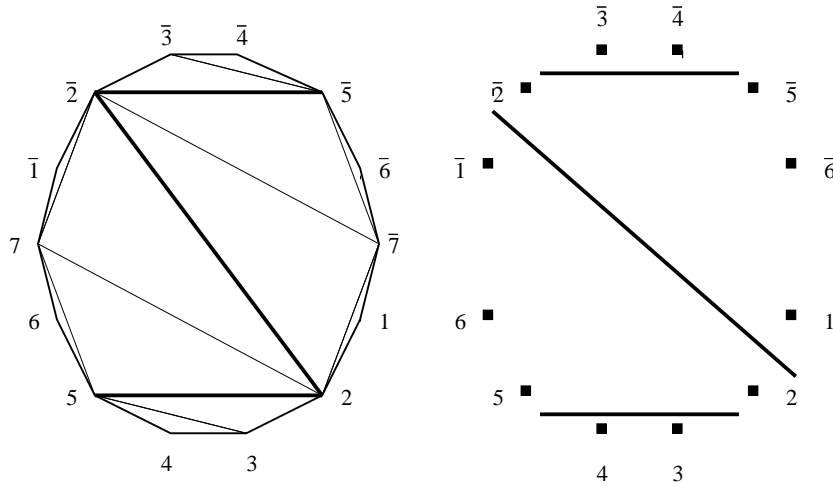

FIGURE 4

**Proposition 4.1.** *The map  $\psi$  is a bijection from  $T_n^B$  to  $NC_n^B$ .*

### 5. EL-Shellability

Recall that an element  $x$  of a lattice  $L$  is said to be left modular if, for all  $y < z \in L$ ,

$$(y \vee x) \wedge z = y \vee (x \wedge z).$$

For  $1 \leq i \leq n$  and  $t \in [1, n - 1] \cup \{*\}$ , let  $S_{i,t}$  denote the triangulation with bracket vector as follows:

$$r_j(S_{i,t}) = \begin{cases} * & \text{for } j > i \\ t & \text{for } j = i \\ 0 & \text{for } j < i. \end{cases}$$

**Lemma 5.1.**  *$S_{i,t} \in T_n^B$  is left modular.*

Since the  $S_{i,t}$  together with  $\hat{0}$  form an unrefinable chain, we have the following theorem:

**Theorem 5.2.**  *$T_n^B$  has an unrefinable chain of left modular elements.*

The analogous fact that  $T_n^A$  possesses a maximal chain of left modular elements was first proved by Blass and Sagan [BS].

It was shown in [Liu] that a lattice having an unrefinable chain of left-modular elements has an EL-labelling. In particular, this shows that the order complex of any interval in such a lattice is shellable and hence contractible or homotopy equivalent to a wedge of spheres. For more on EL-labelling, and EL-shellability, see [Bj, BW1, BW2].

Thus, Theorem 2 implies the following corollary:

**Corollary 5.3.**  *$T_n^B$  is EL-shellable.*

### 6. Homotopy types of intervals

As we have already remarked, the fact that  $T_n^B$  is EL-shellable implies that the order complex of any interval is either contractible or has the homotopy type of a wedge of spheres. In this section, we shall show that it is in fact either contractible or homotopic to a single sphere. One reason that such a result is of interest is that it implies that the Möbius function of any interval in  $T_n^B$  is 0,  $-1$ , or  $1$ .

**Theorem 6.1.** *The order complex of an interval in  $T_n^B$  is either contractible or homotopy equivalent to a single sphere.*

To sketch the proof of Theorem 3, we begin by recalling the EL-labelling of [Liu]. Let  $L$  be a lattice, and let  $\hat{0} = x_0 < x_1 < \dots < x_r = \hat{1}$  be an unrefinable chain of left modular elements. Let  $\mathcal{W}_i$  be the set of join irreducibles below  $x_i$  but not below  $x_{i-1}$ . For  $y < z$  in  $L$ , let  $\mathcal{W}(y, z)$  be the set of irreducibles below  $z$  but not below  $y$ . For any  $S < T$  in  $L$ , label the corresponding edge of the Hasse diagram by:

$$\gamma(S, T) = \min\{i \mid \mathcal{W}_i \cap \mathcal{W}(S, T) \neq \emptyset\}.$$

**Proposition 6.2** ([Liu]). *For  $L$  a lattice with an unrefinable left modular chain, the labelling  $\gamma$  defined above is an EL-labelling.*

In order to interpret this labelling in our case, we need some results about the join-irreducibles of  $T_n^B$ .

For  $1 \leq t \leq i - 1$ , let  $W_{i,t}$  denote the triangulation whose bracket vector consists of  $t$  in the  $i$ -th place, all the other entries being zero.

For  $i \leq t < n$ , let  $W_{i,t}$  denote the triangulation defined by:

$$r_j(W_{i,t}) = \begin{cases} t & \text{for } j = i \\ * & \text{for } j = n + i - t \\ 0 & \text{otherwise} \end{cases}$$

Let  $W_{i,*}$  denote the triangulation whose bracket vector consists of a single  $*$  in the  $i$ -th place, all the other entries being zero.

Write  $\mathcal{W}$  for the set of all the  $W_{i,t}$ .

**Proposition 6.3.** *The join-irreducibles of  $T_n^B$  are exactly  $\mathcal{W}$ . The unique join-irreducible below  $S_{i,t}$  and not below any smaller  $S_{i',t'}$  is  $W_{i,t}$ .*

Recall from [BW2] that given a poset with an EL-labelling, the order complex of an interval  $[y, z]$  is homotopic to a wedge of spheres, one for each unrefinable chain from  $y$  to  $z$  such that the labels strictly decrease as one reads up the chain. Such chains are called *decreasing chains*.

Thus, Theorem 3 follows from the following lemma:

**Lemma 6.4.** *For  $Y < Z \in T_n^B$ , there is at most one decreasing chain from  $Y$  to  $Z$ .*

### 7. Generalizing to Type $BD_n^S$

Here we fix  $n$  and a subset  $S$  of  $[n]$ . We will be operating in type  $BD_n^S$ , a concept introduced in [Rei] which we now explain. This is not a type in the usual sense. Rather, it refers to a certain hyperplane arrangement between those associated to  $B_n$  and  $D_n$ .

Recall that a root system gives rise to a hyperplane arrangement by taking all the hyperplanes through the origin perpendicular to roots. The  $B_n$  arrangement therefore consists of all those hyperplanes defined by  $x_i \pm x_j = 0$ , together with those defined by  $x_i = 0$ , for  $1 \leq i, j \leq n$ , while the  $D_n$  arrangement consists only of those hyperplanes defined by  $x_i \pm x_j = 0$  for  $1 \leq i, j \leq n$ . Now, for  $S \subset [n]$ , the  $BD_n^S$  hyperplane arrangement consists of those hyperplanes defined by  $x_i \pm x_j = 0$  together with  $x_i = 0$  for  $i \notin S$ . When  $S = \emptyset$  we recover  $B_n$ , while if  $S = [n]$  we recover  $D_n$ .

The  $B_n$  partitions,  $\Pi_n^B$ , are by definition those partitions of the set  $\{1, \dots, n, \bar{1}, \dots, \bar{n}\}$  which are fixed under the map interchanging  $i$  and  $\bar{i}$ , and such that there is at most one block which contains any  $i$  and  $\bar{i}$  simultaneously. This is a suitable definition of  $\Pi_n^B$  because its elements are naturally in bijection with the elements of the intersection lattice of the  $B_n$  arrangement.  $NC_n^B$  is a subset of  $\Pi_n^B$ .

The intersection lattice of the  $BD_n^S$  hyperplane arrangement is a subset of that of type  $B_n$ . This allows a natural definition of  $BD_n^S$  partitions,  $\Pi_n^S$ , as a subset of  $\Pi_n^B$ . By this approach, one obtains that  $\Pi_n^S$  consists of those partitions of  $\Pi_n^B$  which do not contain any block  $\{i, \bar{i}\}$  for  $i \in S$ . In [Rei], Reiner defined  $\text{NC}_n^S$ , the non-crossing partitions of type  $BD_n^S$ , by  $\text{NC}_n^S = \text{NC}_n^B \cap \Pi_n^S$ . (For more details on the material sketched in the preceding paragraphs, see [Rei].)

We now define  $T_n^S$  to be those triangulations which correspond under  $\psi$  to partitions in  $\text{NC}_n^S$ . We can describe them more directly as follows:

**Lemma 7.1.**  $T_n^S$  consists of those triangulations which do not contain the triangles  $i, \bar{i}, i+1$  and  $i, \bar{i}, \overline{i+1}$  for any  $i \in S$ .  $T_n^S$  can also be characterized as the set of triangulations  $T$  such that  $r_i(T) \neq n-1$  for any  $i \in S$ .

The remainder of the paper is devoted to sketching the proof of the following theorem, which generalizes Theorems 1, 2, and 3 to the broader context of type  $BD_n^S$ .

**Theorem 7.2.**  $T_n^S$  admits a lattice structure which is a quotient of that on  $T_n^B$ .  $T_n^S$  possesses an unrefinable chain of left modular elements, which implies that it is EL-shellable. Further, the order complex of any interval is either contractible or homotopic to a single sphere.

We define an equivalence relation  $\sim_S$  on  $T_n^B$  as follows: two non-identical triangulations are equivalent iff they differ in that one of them, say  $T$ , is not in  $T_n^S$ , and the other is the triangulation obtained by removing the diameter of  $T$  and replacing it with the other possible diameter.

An equivalence relation  $\sim$  on a lattice  $L$  is said to be a congruence relation if the lattice operations pass to equivalence classes. In this case, there is an induced lattice structure on the equivalence classes (see [Gr]).

**Lemma 7.3.** The relation  $\sim_S$  on  $T_n^B$  is a congruence relation.

Since the equivalence classes of  $\sim_S$  each contain a single element of  $T_n^S$ , the induced lattice structure on  $T_n^B / \sim_S$  gives rise to a lattice structure on  $T_n^S$ .

(One could also define a partial order on  $T_n^S$  by considering the order induced by its inclusion in  $T_n^B$ . It turns out that the order defined in this way coincides with the order we have already defined.)

It is immediate that the property of being left modular passes to equivalence classes, so  $T_n^S$  has a maximal chain of left modular elements, and is therefore EL-shellable. This maximal chain is shorter than that of  $T_n^B$ , because  $S_{i,n-1} \sim_S S_{i,*}$  for  $i \in S$ .

It is easy to see that the join irreducibles of  $T_n^S$  are those  $W_{i,t}$  such that either  $i \notin S$  or  $t \neq n-1$ ; again, they are in bijection with the elements of the left modular chain.

As in the type  $B$  case, the result on homotopy types of intervals follows by showing that there is at most one decreasing chain in any interval in  $T_n^S$ .

### Acknowledgements

I would like to thank Nathan Reading for suggesting the possibility of a type  $B$  Tamari lattice to me, and for his amicable approach to the overlap in our investigations. I would also like to thank Vic Reiner and Christos Athanasiadis for discussions in which many of the ideas that appear in this paper were formed. I would like to thank Vic Reiner, Marcelo Aguiar, Nathan Reading, Nirit Sandman, and two anonymous referees for their comments on previous versions of this manuscript.

### References

- [Bj] A. Björner, *Shellable and Cohen-Macaulay partially ordered sets*, Trans. Amer. Math. Soc. **260** (1980), No. 1, 159–183.
- [BW1] A. Björner and M. Wachs, *Shellable Nonpure Complexes and Posets. I*, Trans. Amer. Math. Soc. **348** (1996), No. 4, 1299–1327.
- [BW2] A. Björner and M. Wachs, *Shellable Nonpure Complexes and Posets. II*, Trans. Amer. Math. Soc. **349** (1997), No. 10, 3945–3975.
- [BS] A. Blass and B. Sagan, *Möbius functions of lattices*, Adv. Math. **127** (1997), 94–123.

- [FZ] S. Fomin and A. Zelevinsky, *Y-Systems and generalized associahedra*, preprint, arXiv:hep-th/0111053 (2001).
- [Gr] G. Grätzer, *General Lattice Theory*, 2nd ed., Birkhäuser Verlag, Basel, 1998.
- [HT] S. Huang and D. Tamari, *Problems of associativity: A simple proof for the lattice property of systems ordered by a semi-associative law*, J. Combin. Theory. Ser. A **13** (1972), 7–13.
- [Lee] C. Lee, *The associahedron and triangulations of the  $n$ -gon*, Europ. J. Combin. **10** (1989) No. 6, 551–560.
- [Liu] L. S.-C. Liu, *Left-modular elements and edge-labelings*, Ph.D. Thesis, Michigan State University, 1999.
- [Pal] J. Pallo, *Some properties of the rotation lattice of binary trees*, Computer J. **31** (1988), 564–565.
- [Rea] N. Reading, *Cambrian Lattices*, preprint, arXiv:math.CO/0402086 (2004).
- [Rei] V. Reiner, *Non-crossing partitions for classical reflection groups*, Discrete Math. **177** (1997), 195–222.
- [San] N. Sandman, *An exploration of a type-B Tamari poset*, Discrete App. Math. (to appear).
- [Sim] R. Simion, *A type-B associahedron*, Adv. in App. Math. **30** (2003), 2–25.
- [Tam] D. Tamari, *The algebra of bracketings and their enumeration*, Nieuw. Arch. Wisk. **10** (1962), 131–146.

FIELDS INSTITUTE, 222 COLLEGE ST., TORONTO ON, M5T 3J1 CANADA

*E-mail address:* `hthomas@fields.utoronto.ca`

*URL:* `http://www.fields.utoronto.ca/hthomas`

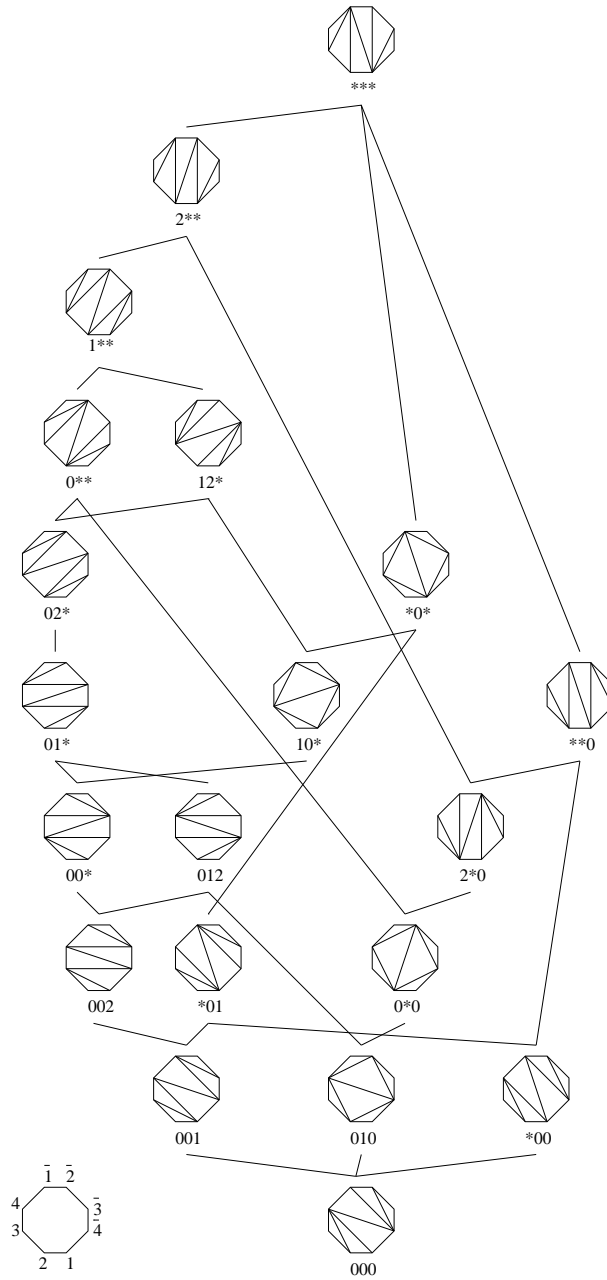

FIGURE 5



## Enumeration of Totally Positive Grassmann Cells

Lauren K. Williams

**Abstract.** In [6], Postnikov gave a combinatorially explicit cell decomposition of the totally nonnegative part of a Grassmannian, denoted  $Gr_{k,n}^+$ , and showed that this set of cells is isomorphic as a graded poset to many other interesting graded posets, such as the posets of decorated permutations,  $\mathcal{J}$ -diagrams (certain  $0-1$  tableau), and positroids. The main result of our work is an explicit generating function which enumerates the cells in  $Gr_{k,n}^+$  according to their dimension. Equivalently, we compute rank generating functions for the posets of decorated permutations,  $\mathcal{J}$ -diagrams, and positroids. As a corollary, we give a new proof that the Euler characteristic of  $Gr_{k,n}^+$  is 1. Additionally, we use our result to produce a new  $q$ -analog of the Eulerian numbers, which interpolates between the Eulerian numbers, the Narayana numbers, and the binomial coefficients.

**Résumé.** Postnikov a décrit explicitement dans [6], en termes combinatoires, la décomposition cellulaire de la partie positive (notée  $Gr_{k,n}^+$ ) d'une variété grassmannienne. Il a montré que cet ensemble de cellules est isomorphe, en tant que treillis gradué, à de nombreux ensembles partiellement ordonnés intéressants, comme les permutations décorées, les  $\mathcal{J}$ -diagrammes (qui sont certains tableaux à coefficients  $0,1$ ) ou les matroïdes positifs. Le résultat principal de notre travail est une fonction génératrice explicite, qui dénombre les cellules de  $Gr_{k,n}^+$  selon leur dimension. De façon équivalente, nous calculons la fonction génératrice, pondérée par le rang, pour le treillis des permutations décorées, des  $\mathcal{J}$ -diagrammes et des matroïdes positifs. Nous en déduisons comme corollaire une nouvelle preuve que la caractéristique d'Euler de  $Gr_{k,n}^+$  est 1. De plus, nous utilisons notre résultat pour exhiber un nouveau  $q$ -analogue des nombres eulériens, qui s'interpole entre les nombres eulériens, les nombres de Narayana et les coefficients binomiaux.

### 1. Introduction

The classical theory of total positivity concerns matrices in which all minors are nonnegative. While this theory was pioneered by Gantmacher, Krein, and Schoenberg in the 1930s, the past decade has seen a flurry of research in this area initiated by Lusztig [3, 4, 5], and continued by works of Fomin and Zelevinsky [1], and Rietsch [7], among others.

Most recently, Postnikov [6] investigated the combinatorics of the totally nonnegative part of a Grassmannian  $Gr_{k,n}^+$ : he produced a combinatorially explicit cell decomposition of  $Gr_{k,n}^+$ , giving the set of cells of  $Gr_{k,n}^+$  a natural structure of graded poset. Furthermore, he showed that this poset was isomorphic to many other interesting combinatorial posets, such as the posets of decorated permutations,  $\mathcal{J}$ -diagrams, positive

---

*Key words and phrases.* Grassmannian, total positivity, Eulerian numbers,  $q$ -analogs.

The author was supported by a National Defense Science and Engineering Graduate Fellowship.

oriented matroids, and move-equivalence classes of planar oriented networks. In this paper we continue Postnikov's study of the combinatorics of  $Gr_{k,n}^+$ : in particular, we enumerate the cells in the cell decomposition of  $Gr_{k,n}^+$  according to their dimension. Equivalently, we compute the rank generating functions for all of the above posets.

The *totally nonnegative part* of the Grassmannian of  $k$ -dimensional subspaces in  $\mathbb{R}^n$  is defined as the quotient  $Gr_{k,n}^+ = GL_k^+ \setminus \text{Mat}^+(k, n)$ , where  $GL_k^+$  is the group of real  $k \times k$  matrices with positive determinant, and  $\text{Mat}^+(k, n)$  is the set of real  $k \times n$ -matrices of rank  $k$  with nonnegative maximal minors. If we specify which maximal minors are strictly positive and which are equal to zero, we obtain a cellular decomposition of  $Gr_{k,n}^+$ , as shown in [6]. We refer to the cells in this decomposition as *totally positive cells*. The set of totally positive cells naturally has the structure of a graded poset: we say that one cell covers another if the closure of the first cell contains the second, and the rank function is the dimension of each cell.

The main result of this paper is an explicit formula for the *rank generating function*  $A_{k,n}(q)$  of  $Gr_{k,n}^+$ . Specifically,  $A_{k,n}(q)$  is defined to be the polynomial in  $q$  whose  $q^r$  coefficient is the number of totally positive cells in  $Gr_{k,n}^+$  which have dimension  $r$ . As a corollary of our main result, we give a new proof that the Euler characteristic of  $Gr_{k,n}^+$  is 1. Additionally, using our result and exploiting the connection between totally positive cells and permutations, we compute generating functions which enumerate (regular) permutations according to two statistics. This leads to a new  $q$ -analog of the Eulerian numbers that has many interesting combinatorial properties. For example, when we evaluate this  $q$ -analog at  $q = 1, 0$ , and  $-1$ , we obtain the Eulerian numbers, the Narayana numbers, and the binomial coefficients. Finally, the connection with the Narayana numbers suggests a way of incorporating noncrossing partitions into a larger family of "crossing" partitions.

Let us fix some notation. Throughout this paper we use  $[i]$  to denote the  $q$ -analog of  $i$ , that is,  $[i] = 1 + q + \dots + q^{i-1}$ . (We will sometimes use  $[n]$  to refer to the set  $\{1, \dots, n\}$ , but the context should make our meaning clear.) Additionally,  $[i]! := \prod_{k=1}^i [k]$  and  $\begin{bmatrix} i \\ j \end{bmatrix} := \frac{[i]!}{[j]![i-j]!}$  are the  $q$ -analogs of  $i!$  and  $\binom{i}{j}$ , respectively.

## 2. J-Diagrams

A *partition*  $\lambda = (\lambda_1, \dots, \lambda_k)$  is a weakly decreasing sequence of nonnegative numbers. For a partition  $\lambda$ , where  $\sum \lambda_i = n$ , the *Young diagram*  $Y_\lambda$  of shape  $\lambda$  is a left-justified diagram of  $n$  boxes, with  $\lambda_i$  boxes in the  $i$ th row. Figure 1 shows a Young diagram of shape  $(4, 2, 1)$ .

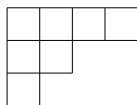

FIGURE 1. A Young diagram of shape  $(4, 2, 1)$

Fix  $k$  and  $n$ . Then a *J-diagram*  $(\lambda, D)_{k,n}$  is a partition  $\lambda$  contained in a  $k \times (n - k)$  rectangle (which we will denote by  $(n - k)^k$ ), together with a filling  $D : Y_\lambda \tilde{\Omega}\{0, 1\}$  which has the *J-property*: there is no 0 which has a 1 above it and a 1 to its left. (Here, "above" means above and in the same column, and "to its left" means to the left and in the same row.) In Figure 2 we give an example of a J-diagram.<sup>1</sup>

We define the rank of  $(\lambda, D)_{k,n}$  to be the number of 1's in the filling  $D$ . Postnikov proved that there is a one-to-one correspondence between J-diagrams  $(\lambda, D)$  contained in  $(n - k)^k$ , and totally positive cells in  $Gr_{k,n}^+$ , such that the dimension of a totally positive cell is equal to the rank of the corresponding J-diagram. He proved this by providing a modified Gram-Schmidt algorithm  $A$ , which has the property that it maps a

<sup>1</sup>The symbol J is meant to remind the reader of the shape of the forbidden pattern, and should be pronounced as [le], because of its relationship to the letter L. See [6] for some interesting numerological remarks on this symbol.

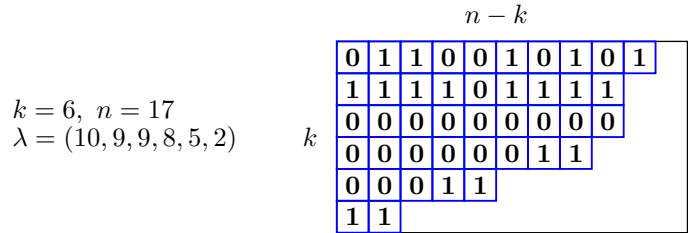

FIGURE 2. A  $\mathcal{J}$ -diagram  $(\lambda, D)_{k,n}$

real  $k \times n$  matrix of rank  $k$  with nonnegative maximal minors to another matrix whose entries are all positive or 0, which has the  $\mathcal{J}$ -property. In brief, the bijection between totally positive cells and  $\mathcal{J}$ -diagrams maps a matrix  $M$  (representing some totally positive cell) to a  $\mathcal{J}$ -diagram whose 1's represent the positive entries of  $A(M)$ .

Because of this correspondence, in order to compute  $A_{k,n}(q)$ , we need to enumerate  $\mathcal{J}$ -diagrams contained in  $(n - k)^k$  according to their number of 1's.

### 3. Decorated Permutations and the Cyclic Bruhat Order

The poset of decorated permutations (also called the cyclic Bruhat order) was introduced by Postnikov in [6]. A *decorated permutation*  $\tilde{\pi} = (\pi, d)$  is a permutation  $\pi$  in the symmetric group  $S_n$  together with a coloring (decoration)  $d$  of its fixed points  $\pi(i) = i$  by two colors. Usually we refer to these two colors as “clockwise” and “counterclockwise,” for reasons which the next paragraph will make clear.

We represent a decorated permutation  $\tilde{\pi} = (\pi, D)$ , where  $\pi \in S_n$ , by its *chord diagram*, constructed as follows. Put  $n$  equally spaced points around a circle, and label these points from 1 to  $n$  in clockwise order. If  $\pi(i) = j$  then this is represented as a directed arrow, or chord, from  $i$  to  $j$ . If  $\pi(i) = i$  then we draw a chord from  $i$  to  $i$  (i.e. a loop), and orient it either clockwise or counterclockwise, according to  $d$ . We refer to the chord which begins at position  $i$  as  $\text{Chord}(i)$ , and we use  $ij$  to denote the directed chord from  $i$  to  $j$ . Also, if  $i, j \in \{1, \dots, n\}$ , we use  $\text{Arc}(i, j)$  to denote the set of points that we would encounter if we were to travel clockwise from  $i$  to  $j$ , including  $i$  and  $j$ .

For example, the decorated permutation  $(3, 1, 5, 4, 8, 6, 7, 2)$  (written in list notation) with the fixed points 4, 6, and 7 colored in counterclockwise, clockwise, and counterclockwise, respectively, is represented by the chord diagram in Figure 3.

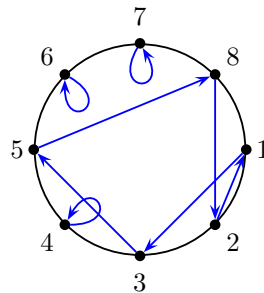

FIGURE 3. A chord diagram for a decorated permutation

The symmetric group  $S_n$  acts on the permutations in  $S_n$  by conjugation. This action naturally extends to an action of  $S_n$  on decorated permutations, if we specify that the action of  $S_n$  sends a clockwise (respectively, counterclockwise) fixed point to a clockwise (respectively, counterclockwise) fixed point.

We say that a pair of chords in a chord diagram forms a *crossing* if they intersect inside the circle or on its boundary.

Every crossing looks like Figure 4, where the point  $A$  may coincide with the point  $B$ , and the point  $C$

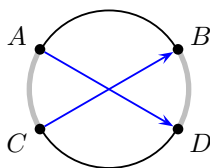

FIGURE 4. A crossing

may coincide with the point  $D$ . A crossing is called a *simple crossing* if there are no other chords that go from  $\text{Arc}(C, A)$  to  $\text{Arc}(B, D)$ . Say that two chords are *crossing* if they form a crossing.

Let us also say that a pair of chords in a chord diagram forms an *alignment* if they are not crossing and they are relatively located as in Figure 5. Here, again, the point  $A$  may coincide with the point  $B$ , and

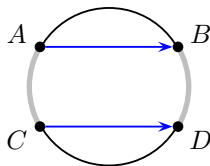

FIGURE 5. An alignment

the point  $C$  may coincide with the point  $D$ . If  $A$  coincides with  $B$  then the chord from  $A$  to  $B$  should be a counterclockwise loop in order to be considered an alignment with  $\text{Chord}(C)$ . (Imagine what would happen if we had a piece of string pointing from  $A$  to  $B$ , and then we moved the point  $B$  to  $A$ ). And if  $C$  coincides with  $D$  then the chord from  $C$  to  $D$  should be a clockwise loop in order to be considered an alignment with  $\text{Chord}(A)$ . As before, an alignment is a *simple alignment* if there are no other chords that go from  $\text{Arc}(C, A)$  to  $\text{Arc}(B, D)$ . We say that two chords are *aligned* if they form an alignment.

We now define a partial order on the set of decorated permutations. For two decorated permutations  $\pi_1$  and  $\pi_2$  of the same size  $n$ , we say that  $\pi_1$  *covers*  $\pi_2$ , and write  $\pi_1 \tilde{\Omega} \pi_2$ , if the chord diagram of  $\pi_1$  contains a pair of chords that forms a simple crossing and the chord diagram of  $\pi_2$  is obtained by changing them to the pair of chords that forms a simple alignment: If the points  $A$  and  $B$  happen to coincide then the chord from  $A$  to  $B$  in the chord diagram of  $\pi_2$  degenerates to a counterclockwise loop. And if the points  $C$  and  $D$  coincide then the chord from  $C$  to  $D$  in the chord diagram of  $\pi_2$  becomes a clockwise loop. These degenerate situations are illustrated in Figure 7.

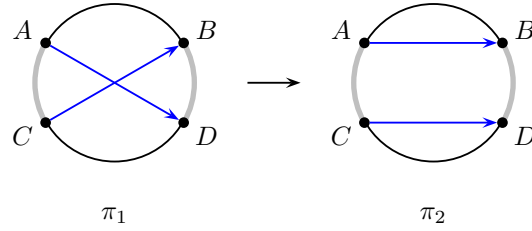

FIGURE 6. Covering relation

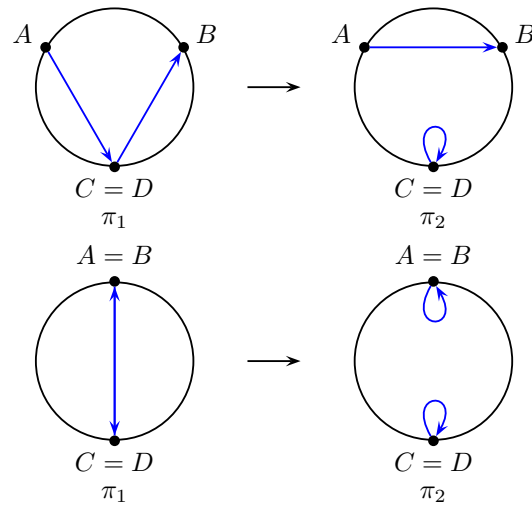
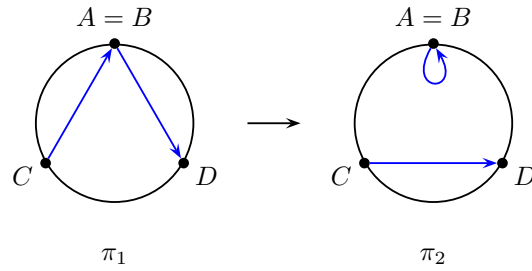

FIGURE 7. Degenerate covering relations

Let us define two statistics  $A$  and  $K$  on decorated permutations. For a decorated permutation  $\pi$ , the numbers  $A(\pi)$  and  $K(\pi)$  are given by

$$A(\pi) = \#\{\text{pairs of chords forming an alignment}\},$$

$$K(\pi) = \#\{i \mid \pi(i) > i\} + \#\{\text{counterclockwise loops}\}.$$

In our previous example  $\pi = (3, 1, 5, 4, 8, 6, 7, 2)$  we have  $A = 11$  and  $K = 5$ . The 11 alignments in  $\pi$  are  $(13, 66), (21, 35), (21, 58), (21, 44), (21, 77), (35, 44), (35, 66), (44, 66), (58, 77), (66, 77), (66, 82)$ .

**Lemma 3.1.** [6] *If  $\pi_1$  covers  $\pi_2$  then  $A(\pi_1) = A(\pi_2) - 1$  and  $K(\pi_1) = K(\pi_2)$ .*

Note that if  $\pi_1$  covers  $\pi_2$  then the number of crossings in  $\pi_1$  is greater than the number of crossings in  $\pi_2$ . But the difference of these numbers is not always 1.

Lemma 3.1 implies that the transitive closure of the covering relation “ $\tilde{\Omega}$ ” has the structure of a partially ordered set and this partially ordered set decomposes into  $n + 1$  incomparable components. For  $0 \leq k \leq n$ , we define the *cyclic Bruhat order*  $\mathcal{CB}_{kn}$  as the set of all decorated permutations  $\pi$  of size  $n$  such that  $K(\pi) = k$  with the partial order relation obtained by the transitive closure of the covering relation “ $\tilde{\Omega}$ ”. By Lemma 3.1 the function  $A$  is the corank function for the cyclic Bruhat order  $\mathcal{CB}_{kn}$ .

The definitions of the covering relation and of the statistic  $A$  will not change if we rotate a chord diagram. The definition of  $K$  depends on the order of the boundary points  $1, \dots, n$ , but it is not hard to see that the statistic  $K$  is invariant under the cyclic shift  $\text{conj}_\sigma$  for the long cycle  $\sigma = (1, 2, \dots, n)$ . Thus the order  $\mathcal{CB}_{kn}$  is invariant under the action of the cyclic group  $\mathbb{Z}/n\mathbb{Z}$  on decorated permutations.

In [6], Postnikov proved that the number of totally positive cells in  $Gr_{k,n}^+$  of dimension  $r$  is equal to the number of decorated permutations in  $\mathcal{CB}_{kn}$  of rank  $r$ . Thus,  $A_{k,n}(1)$  is the cardinality of  $\mathcal{CB}_{kn}$ , and the coefficient of  $q^{k(n-k)-\ell}$  in  $A_{k,n}(q)$  is the number of decorated permutations in  $\mathcal{CB}_{kn}$  with  $\ell$  alignments.

#### 4. The Rank Generating Function of $Gr_{k,n}^+$

Recall that the coefficient of  $q^r$  in  $A_{k,n}(q)$  is the number of cells of dimension  $r$  in the cellular decomposition of  $Gr_{k,n}^+$ . In this section we give an explicit expression for  $A_{k,n}(q)$ , as well as expressions for the generating functions  $A_k(q, x) := \sum_n A_{k,n}(q)x^n$  and  $A(q, x, y) := \sum_{k \geq 1} \sum_n A_{k,n}(q)x^n y^k$ . Our main theorem is the following:

**Theorem 4.1.**

$$\begin{aligned} A(q, x, y) &= \frac{-y}{q(1-x)} + \sum_{i \geq 1} \frac{y^i (q^{2i+1} - y)}{q^{i^2+i+1} (q^i - q^i [i+1]x + [i]xy)} \\ A_k(q, x) &= \sum_{i=0}^{k-1} (-1)^{i+k} \frac{x^{k-i-1} [i]^{k-i-1}}{q^{ki+i+1} (1 - [i+1]x)^{k-i}} + \sum_{i=0}^k (-1)^{i+k} \frac{x^{k-i} [i]^{k-i}}{q^{ki} (1 - [i+1]x)^{k-i+1}} \\ A_{k,n}(q) &= q^{-k^2} \sum_{i=0}^{k-1} (-1)^i \binom{n}{i} (q^{ki} [k-i]^i [k-i+1]^{n-i} - q^{(k+1)i} [k-i-1]^i [k-i]^{n-i}) \\ &= \sum_{i=0}^{k-1} \binom{n}{i} q^{-(k-i)^2} ([i-k]^i [k-i+1]^{n-i} - [i-k+1]^i [k-i]^{n-i}). \end{aligned}$$

**Corollary 4.2.** *The Euler characteristic of the totally non-negative part of the Grassmannian  $Gr_{k,n}^+$  is 1.*

Recall that the Euler characteristic of a cell complex is defined to be  $\sum_i (-1)^i f_i$ , where  $f_i$  is the number of cells of dimension  $i$ . So to prove Corollary 4.2, simply set  $q = -1$  in Theorem 4.1 and simplify.

One interesting ingredient in the proof of Theorem 4.1 is the following lemma. We prove this lemma by interpreting the two equations as statements about partitions, and overpartitions, respectively. Alternatively, Christian Krattenthaler has pointed out to us that this lemma follows from the  ${}_1\phi_1$  summation described in Appendix II.5 of [2].

**Lemma 4.3.**

$$(4.1) \quad \sum_{i \geq 0} (-1)^i y^i q^{\binom{i+1}{2}} \prod_{r=1}^{i+1} \frac{1}{1 - q^r y} = 1.$$

$$(4.2) \quad (-1)^j q^{-\binom{j+1}{2}} y^{-j} \sum_{i \geq j} (-1)^i q^{\binom{i+1}{2}} \begin{bmatrix} i \\ j \end{bmatrix} y^i \prod_{r=1}^{i+1} \frac{1}{1 - q^{r+j} y} = 1.$$

In Table 1, we have listed some of the values of  $A_{k,n}(q)$  for small  $k$  and  $n$ . It is easy to see from the definition of  $\mathbb{J}$ -diagrams that  $A_{k,n}(q) = A_{n-k,n}(q)$ : one can reflect a  $\mathbb{J}$ -diagram  $(\lambda, D)_{k,n}$  of rank  $r$  over the main diagonal to get another  $\mathbb{J}$ -diagram  $(\lambda', D')_{n-k,n}$  of rank  $r$ . Alternatively, one should be able to prove the claim directly from the expression in Theorem 4.1, using some  $q$ -analogue of Abel’s identity.

$A_{1,1}(q)$	1
$A_{1,2}(q)$	$q + 2$
$A_{1,3}(q)$	$q^2 + 3q + 3$
$A_{1,4}(q)$	$q^3 + 4q^2 + 6q + 4$
$A_{2,4}(q)$	$q^4 + 4q^3 + 10q^2 + 12q + 6$
$A_{2,5}(q)$	$q^6 + 5q^5 + 15q^4 + 30q^3 + 40q^2 + 30q + 10$
$A_{2,6}(q)$	$q^8 + 6q^7 + 21q^6 + 50q^5 + 90q^4 + 120q^3 + 110q^2 + 60q + 15$
$A_{3,6}(q)$	$q^9 + 6q^8 + 21q^7 + 56q^6 + 114q^5 + 180q^4 + 215q^3 + 180q^2 + 90q + 20$
$A_{3,7}(q)$	$q^{12} + 7q^{11} + 28q^{10} + 84q^9 + 203q^8 + 406q^7 + 679q^6 + 938q^5 + 1050q^4 + 910q^3 + 560q^2 + 210q + 35$

TABLE 1.  $A_{k,n}(q)$

Note that it is possible to see directly from the definition that  $Gr_{1,n}^+$  is just some deformation of a simplex with  $n$  vertices. This explains the simple form of  $A_{1,n}(q)$ .

### 5. A New $q$ -Analog of the Eulerian Numbers

If  $\pi \in S_n$ , we say that  $\pi$  has a *weak excedence* at position  $i$  if  $\pi(i) \geq i$ . The *Eulerian number*  $E_{k,n}$  is the number of permutations in  $S_n$  which have  $k$  weak excedences. (One can define the Eulerian numbers in terms of other statistics, such as descent, but this will not concern us here.)

Using the rank generating function for the poset of decorated permutations, we can enumerate (regular) permutations according to two statistics: weak excedences and alignments. This gives us a new  $q$ -analogue of the Eulerian numbers.

Recall that the statistic  $K$  on decorated permutations was defined as

$$K(\pi) = \#\{i \mid \pi(i) > i\} + \#\{\text{counterclockwise loops}\}.$$

Note that  $K$  is related to the notion of weak excedence in permutations. In fact, we can extend the definition of weak excedence to decorated permutations by saying that a decorated permutation has a weak excedence in position  $i$ , if  $\pi(i) > i$ , or if  $\pi(i) = i$  and  $d(i)$  is counterclockwise. This makes sense, since the limit of a chord from 1 to 2 as 1 approaches 2, is a counterclockwise loop. Then  $K(\pi)$  is the number of weak excedences in  $\pi$ .

We will call a decorated permutation *regular* if all of its fixed points are oriented counterclockwise. Thus, a fixed point of a regular permutation will always be a weak excedence, as it should be. Recall that the Eulerian number  $E_{k,n}$  is the number of permutations of  $[n]$  with  $k$  weak excedences. Earlier, we saw that the coefficient of  $q^{k(n-k)-\ell}$  in  $A_{k,n}(q)$  is the number of decorated permutations in  $\mathcal{CB}_{kn}$  with  $\ell$  alignments. By analogy, let  $E_{k,n}(q)$  be the polynomial in  $q$  whose coefficient of  $q^{k(n-k)-\ell}$  is the number of (regular) permutations with  $k$  weak excedences and  $\ell$  alignments. Thus, the family  $E_{k,n}(q)$  will be a  $q$ -analogue of the Eulerian numbers.

We can relate decorated permutations to regular permutations via the following lemma.

**Lemma 5.1.**

$$E_{k,n}(q) = \sum_{i=0}^n (-1)^i \binom{n}{i} A_{k,n-i}(q).$$

Putting this together with Theorem 4.1, we get the following.

**Corollary 5.2.**

$$E_{k,n}(q) = q^{n-k^2} \sum_{i=0}^{k-1} (-1)^i [k-i]^n q^{ki-k} \left( \binom{n}{i} q^{k-i} + \binom{n}{i-1} \right).$$

Notice that by substituting  $q = 1$  into the formula, we get

$$E_{k,n} = \sum_{i=0}^k (-1)^i \binom{n+1}{i} (k-i)^n,$$

the well-known exact formula for the Eulerian numbers.

Now we will investigate the properties of  $E_{k,n}(q)$ . Actually, since  $E_{k,n}(q)$  is a multiple of  $q^{n-k}$ , we first define  $\hat{E}_{k,n}(q)$  to be  $q^{k-n} E_{k,n}(q)$ , and then work with this renormalized polynomial. Table 2 lists  $\hat{E}_{k,n}(q)$  for  $n = 4, 5, 6, 7$ .

$\hat{E}_{1,4}(q)$	1
$\hat{E}_{2,4}(q)$	$6 + 4q + q^2$
$\hat{E}_{3,4}(q)$	$6 + 4q + q^2$
$\hat{E}_{4,4}(q)$	1
$\hat{E}_{1,5}(q)$	1
$\hat{E}_{2,5}(q)$	$10 + 10q + 5q^2 + q^3$
$\hat{E}_{3,5}(q)$	$20 + 25q + 15q^2 + 5q^3 + q^4$
$\hat{E}_{4,5}(q)$	$10 + 10q + 5q^2 + q^3$
$\hat{E}_{5,5}(q)$	1
$\hat{E}_{1,6}(q)$	1
$\hat{E}_{2,6}(q)$	$15 + 20q + 15q^2 + 6q^3 + q^4$
$\hat{E}_{3,6}(q)$	$50 + 90q + 84q^2 + 50q^3 + 21q^4 + 6q^5 + q^6$
$\hat{E}_{4,6}(q)$	$50 + 90q + 84q^2 + 50q^3 + 21q^4 + 6q^5 + q^6$
$\hat{E}_{5,6}(q)$	$15 + 20q + 15q^2 + 6q^3 + q^4$
$\hat{E}_{6,6}(q)$	1
$\hat{E}_{1,7}(q)$	1
$\hat{E}_{2,7}(q)$	$21 + 35q + 35q^2 + 21q^3 + 7q^4 + q^5$
$\hat{E}_{3,7}(q)$	$105 + 245q + 308q^2 + 259q^3 + 161q^4 + 77q^5 + 28q^6 + 7q^7 + q^8$
$\hat{E}_{4,7}(q)$	$175 + 441q + 588q^2 + 532q^3 + 364q^4 + 196q^5 + 84q^6 + 28q^7 + 7q^8 + q^9$
$\hat{E}_{5,7}(q)$	$105 + 245q + 308q^2 + 259q^3 + 161q^4 + 77q^5 + 28q^6 + 7q^7 + q^8$
$\hat{E}_{6,7}(q)$	$21 + 35q + 35q^2 + 21q^3 + 7q^4 + q^5$
$\hat{E}_{7,7}(q)$	1

TABLE 2.  $\hat{E}_{k,n}(q)$

We can make a number of observations about these polynomials. For example, we can generalize the well-known result that  $E_{k,n} = E_{n+1-k,n}$ , where  $E_{k,n}$  is the Eulerian number corresponding to the number of permutations of  $S_n$  with  $k$  weak excedences.

**Proposition 5.3.**  $\hat{E}_{k,n}(q) = \hat{E}_{n+1-k,n}(q)$ .



**Proposition 5.4.** [6] *The coefficient of the highest degree term of  $\hat{E}_{k,n}(q)$  is 1.*

**Proposition 5.5.**  $\hat{E}_{k,n}(-1) = \pm \binom{n-1}{k-1}$ .

**Proposition 5.6.**  $\hat{E}_{k,n}(q)$  is a polynomial of degree  $(k-1)(n-k)$ , and  $\hat{E}_{k,n}(0)$  is the Narayana number  $N_{k,n} = \frac{1}{n} \binom{n}{k} \binom{n}{k-1}$ .

**Corollary 5.7.**  $\hat{E}_{k,n}(q)$  interpolates between the Eulerian numbers, the Narayana numbers, and the binomial coefficients, at  $q = 1, 0$ , and  $-1$ , respectively.

**Remark 5.8.** The coefficients of  $\hat{E}_{k,n}(q)$  appear to be unimodal. However, these polynomials do not in general have real zeroes.

### 6. Connection with Narayana Numbers

A *noncrossing partition* of the set  $[n]$  is a partition  $\pi$  of the set  $[n]$  with the property that if  $a < b < c < d$  and some block  $B$  of  $\pi$  contains both  $a$  and  $c$ , while some block  $B'$  of  $\pi$  contains both  $b$  and  $d$ , then  $B = B'$ . Graphically, we can represent a noncrossing partition on a circle which has  $n$  labeled points equally spaced around it. We represent each block  $B$  as the polygon whose vertices are the elements of  $B$ . Then the condition that  $\pi$  is noncrossing just means that no two blocks (polygons) intersect each other.

It is known that the number of noncrossing partitions of  $[n]$  which have  $k$  blocks is equal to the Narayana number  $N_{k,n} = \frac{1}{n} \binom{n}{k} \binom{n}{k-1}$  (see Exercise 68e in [8]).

To prove the following proposition we will find a bijection between permutations of  $S_n$  with  $k$  excedences and the maximal number of alignments, and noncrossing partitions on  $[n]$ .

**Proposition 6.1.** *Fix  $k$  and  $n$ . Then  $(k-1)(n-k)$  is the maximal number of alignments that a permutation in  $S_n$  with  $k$  weak excedences can have. The number of permutations in  $S_n$  with  $k$  weak excedences that achieve the maximal number of alignments is the Narayana number  $N_{k,n} = \frac{1}{n} \binom{n}{k} \binom{n}{k-1}$ .*

To figure out what the maximal-alignment permutations look like, imagine starting from any given permutation and applying the covering relations in the cyclic Bruhat order as many times as possible, such that the result is a regular permutation. Note that of the four cases of the covering relation (illustrated in section 3), we can use only the first and second cases. We cannot use the third and fourth operations because these add clockwise fixed points, which are not allowed in regular permutations. It is easy to see that after applying the first two operations as many times as possible, the resulting permutation will have no crossings among its chords and all cycles will be directed counterclockwise.

The map from maximal-alignment permutations to noncrossing partitions is now obvious. We simply take our permutation and then erase the directions on the edges. Since the covering relations in the cyclic Bruhat order preserve the number of weak excedences, and since each counterclockwise cycle in a permutation contributes one weak excedence, the resulting noncrossing partitions will all have  $k$  blocks. In Figure 8 we show the permutations in  $S_4$  which have 2 weak excedences and 2 alignments, along with the corresponding noncrossing partitions.

Conversely, if we start with a noncrossing partition on  $[n]$  which has  $k$  blocks, and then orient each cycle counterclockwise, then this gives us a maximal-alignment permutation with  $k$  weak excedences.

**Corollary 6.2.** *The number of permutations in  $S_n$  which have the maximal number of alignments, given their weak excedences, is  $C_n = \frac{1}{n} \binom{2n}{n+1}$ , the  $n$ th Catalan number.*

PROOF. It is known that  $\sum_k N_{k,n} = C_n$ . □

**Remark 6.3.** The bijection between maximal-alignment permutations and noncrossing partitions is especially interesting because the connection gives a way of incorporating noncrossing partitions into a larger family of “crossing” partitions; this family of crossing partitions is a ranked poset, graded by alignments.

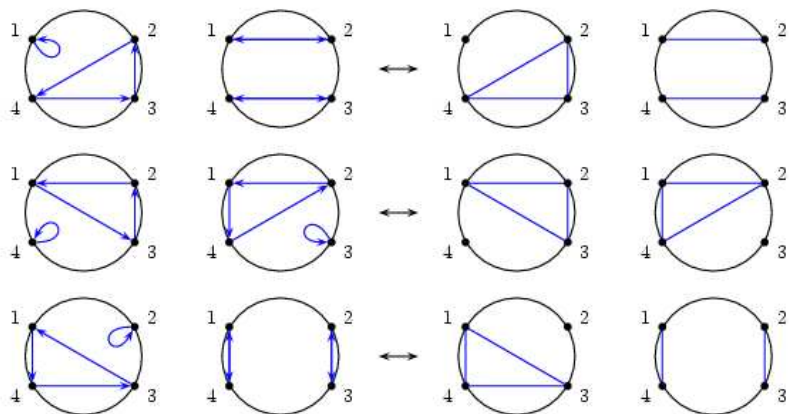

FIGURE 8. The bijection between maximal-alignment permutations and noncrossing partitions

### References

- [1] S. Fomin, A. Zelevinsky, *Double Bruhat cells and total positivity*, Journal of the American Mathematical Society, **12** (1999) no. 2, 335-380.
- [2] G. Gasper, M. Rahman, *Basic hypergeometric series*, Cambridge University Press, New York, 1990.
- [3] G. Lusztig, *Introduction to total positivity*, in *Positivity in Lie theory: open problems*, ed. J. Hilgert, J.D. Lawson, K.H. Neeb, E.B. Vinberg, de Gruyter Berlin, 1998, 133-145.
- [4] G. Lusztig, *Total positivity in partial flag manifolds*, Representation Theory, **2** (1998) 70-78.
- [5] G. Lusztig, *Total positivity in reductive groups*, in: *Lie theory and geometry: in honor of Bertram Kostant*, Progress in Mathematics **123**, Birkhauser, 1994.
- [6] A. Postnikov, *Webs in Totally positive Grassman cells*, in preparation.
- [7] K. Rietsch, *Total positivity and real flag varieties*, Ph.D. Dissertation, MIT, 1998.
- [8] R. Stanley, *Enumerative combinatorics volume 2*, Cambridge University Press, New York, 1999.

DEPARTMENT OF MATHEMATICS, MIT, CAMBRIDGE, MA, USA, 02139  
*E-mail address:* lauren@math.mit.edu

## Index of Authors and Keywords

- Abramov, S., 29  
affine symmetric group, 165  
affine Weyl group, 177  
Albert, M. H., 37  
alcoves, 177  
Alexander duality, 11  
algebraic combinatorics, 239, 279  
alternating sign matrices, 115  
Ardila, Federico, 47  
artic circle theorem, 217  
asymptotics, 17
- basic representation, 189  
Bergeron, François, 57  
Biagioli, Riccardo, 57  
Biggs, Norman, 5  
bijections, 97  
bijective proof, 67  
Billey, Sara, 9  
Boulet, Cilanne, 67  
Brändén, Petter, 71  
Bruhat order, 177
- Cambrian lattices, 251  
Catalan numbers, 97  
cd-index, 141  
Chevally formula, 177  
chromatic polynomials, 5  
classical types, 289  
cluster method, 37  
crystal bases, 19  
crystal graph, 189  
crystals, 127  
cube recurrence, 217
- Dartois, Arnaud, 83  
Demazure module, 189  
Demazure characters, 177  
discrete geometry, 47  
distributive lattice, 141  
Duchi, Enrica, 97
- EL-labelling, 289  
enriched  $P$ -partition, 141  
equivariant cohomology, 229  
Eulerian numbers, 299  
Eulerian poset, 141  
eulerian walker, 83
- fermionic formulas, 19  
finite automata, 71  
flag  $f$ -vector, 141
- generalized flag variety, 177  
generating functions, 17  
Grassmannian, 9, 299  
groves, 217
- Hamel, A. M., 115  
Henriques, André, 127  
Hibi, Takayuki, 11  
hives, 127  
Hopf algebras, 205  
Hsaio, Samuel, 141  
hypergeometric term, 29  
hyperplane arrangements, 229
- irreducible representation, 177
- Kamnitzer, Joel, 127  
King, R. C., 115  
Klivans, Caroline, 47  
Knutson, Allen, 13  
Kostka polynomials, 279
- Lam, Thomas, 153  
Lapoint, Luc, 165  
Le, H. Q., 29  
left modularity, 289  
Lenart, Cristian, 177  
linear systems, 29  
Littelman path model, 177  
Littlewood-Richardson Coefficients, 57, 239  
Loday, Jean-Louis, 15
- Macdonald polynomials, 165  
Magyar, Peter, 189  
markov chains, 97  
Martin, Jeremy, 197  
matroids, 47  
meander, 37  
minuscule representation, 189  
Morse, Jennifer, 165
- $n$ -cube, 23  
Neggers-StanleyPoset conjecture, 141  
non equilibrium statistical physics, 97  
non-crossing partitions, 289  
Novelli, J.-C., 205
- operads, 15
- parallel matroid, 197  
parking functions, 205  
partition identity, 67  
partitions, 67  
Paterson, M. S., 37  
pattern avoidance, 71  
peak algebra, 141  
Pemantle, Robin, 17  
percolation, 23  
permutation array, 9  
Petersen, T. Kyle, 217  
phase transition, 23  
phylogenetics trees, 47

Picture space, 197  
 Poincaré series, 197  
 Postnikov, Alexander, 177  
 Proudfoot, Nicholas, 229  
  
 $q$ -analogs, 299  
 quasi-symmetric functions, 205  
 quasisymmetric function, 141  
  
 random graph, 23  
 Rassart, Etienne, 239  
 Reading, Nathan, 251  
 Reiner, Victor, 269  
 Rhoades, Brendon, 259  
 ribbon tableaux, 153  
 rigged configurations, 19  
 Rosas, Mercedes, 57  
 Rossin, Dominique, 83  
  
 sandpile, 83  
 Schaeffer, Gilles, 97  
 Schubert calculus, 197  
 Schubert varieties, 13  
 Schur  $P$ -functions, 115  
 Schur-positivity, 57  
 semisimple Lie group, 177  
 shifted tableaux, 115  
 Shimozono, Mark, 279  
 Skandera, Mark, 259  
 Slade, Gordon, 23  
 Speyer, David, 217  
 symmetric functions, 57, 165, 279  
  
 Tamari lattice, 289  
 Taskin, Muge, 269  
 Temperley-Lieb algebras, 259  
 tensor product multiplicities, 239  
 Thibon, J.-Y., 205  
 Thomas, Hugh, 289  
 total nonnegativity, 259  
 totalpositivity, 299  
 trees, 205  
 Tutte polynomial, 197  
  
 vector partition functions, 239  
  
 Williams, Lauren K., 299  
  
 Yang-Baxter equation, 177  
 Young tableaux, 115, 127, 153, 269  
  
 Zabrocki, Mike, 279  
 Zeilberger's algorithm, 29